

TM 9-471

WAR DEPARTMENT

**TECHNICAL MANUAL**

**16-INCH SEACOAST GUN MATERIEL  
GUN MK. II M1  
BARBETTE CARRIAGE M4**

NOVEMBER 3, 1942

*Rescinded by  
D/A Circular 310-31  
dtg. 4 JAN 56*

f  
3  
5  
6  
8  
8  
9  
35  
07  
10  
12  
313  
315  
323

44753

TM 9-471  
C 1

TECHNICAL MANUAL  
16-INCH SEACOAST GUN MATÉRIEL GUN MK. II M1  
BARBETTE CARRIAGE M4

CHANGES }  
No. 1 }

WAR DEPARTMENT,  
WASHINGTON 25, D. C., 15 September 1943.

TM 9-471, 3 November 1942, is changed as follows:

Section IX (ADDED)

SIGHTING AND FIRE-CONTROL EQUIPMENT

39.1. General.—*a. Scope.*—This section covers a general description of the on-carriage fire control and sighting equipment for the 16-inch barbette carriage M4, with instructions for operation of the equipment, and necessary care and maintenance to be performed by battery personnel.

*b.* (1) The fire control equipment forms a coordinated system for placing a target under effective fire in the minimum amount of time.

(2) The complete fire-control equipment includes instruments for determining target data, plotting room equipment for translating the target data into gun pointing data, and a data transmission system for transmitting the gun pointing data from the plotting room to the guns. The gun pointing data consists of firing azimuth (in degrees and hundredths) and elevation (in mils).

(3) The data transmission system M5 is used with the 16-inch barbette carriage M4. Arrangement of the system is shown in figure 173.1. The system includes an azimuth indicator M6 and an elevation indicator M5 for each carriage. The indicators are mounted on the carriage near the traversing and elevating handwheels, respectively. The indicators have "match-the-pointer" dials. The handwheel operators keep the dial pointers matched and thereby apply the transmitted data to the gun. A ready signal lamp in each indicator shows when the transmitted data are correct for firing.

(4) The indicators receive their data either from the gun data computer M1, or from the azimuth transmitter M5 and elevation transmitter M6. The gun data computer and the transmitters are in the plotting room. The transmitters are used in connection with the conventional plotting board method of determining gun pointing data. The gun data computer automatically computes gun pointing data directly from the target data, and in effect replaces the transmitters and plotting board equipment.

TECHNICAL MANUAL

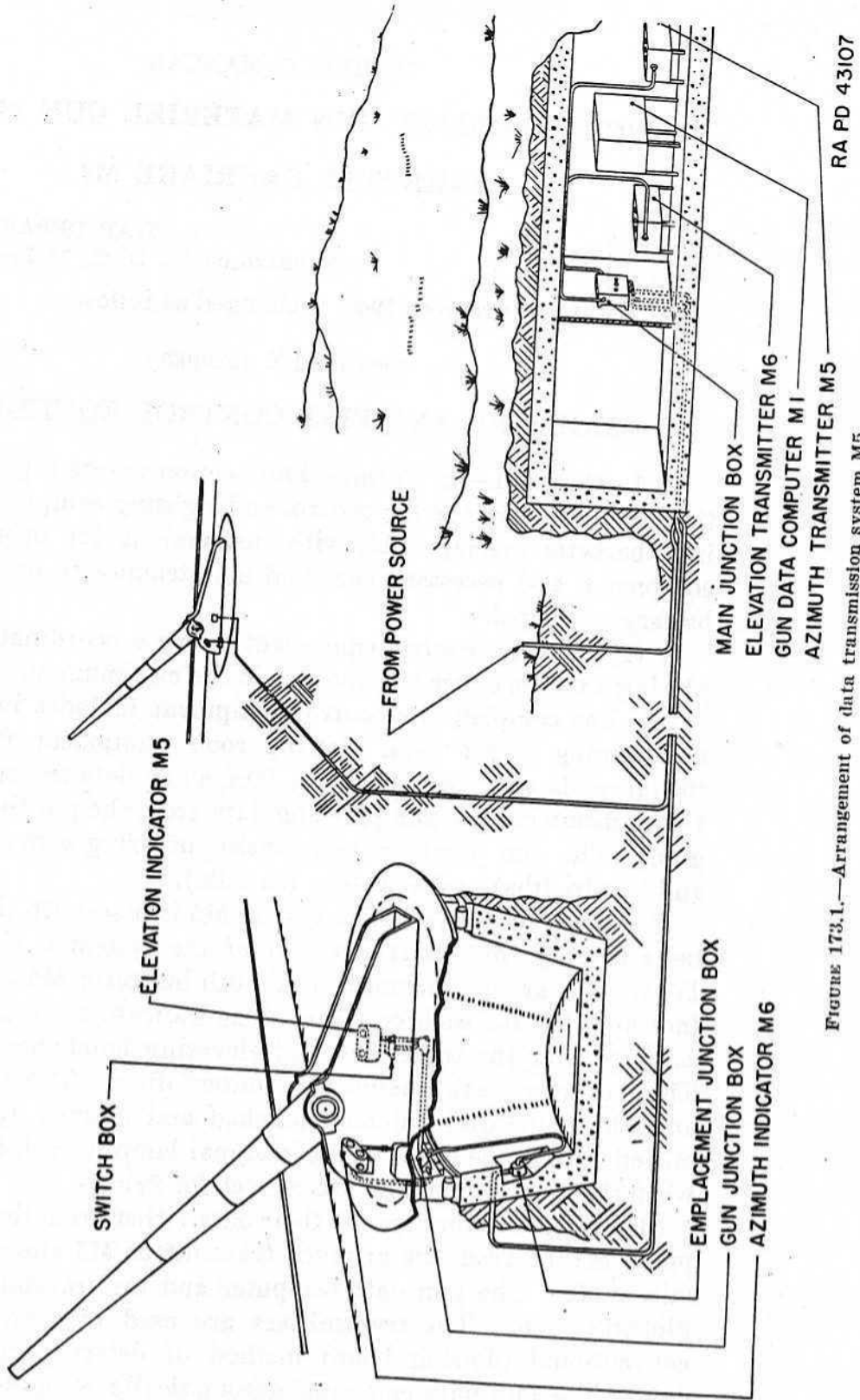

FIGURE 173.1.—Arrangement of data transmission system M5.

(5) The data transmission system and gun data computer operate from a 115-volt, 60-cycle a-c power source. In some installations, a generating unit M6 may be furnished as an emergency power source. The generating unit is covered in TM 9-2617.

(6) The plotting room receives target data from the instruments in the base end stations and spotting stations by base end data transmission system, telephone, or other means of communication. The telephone communication facilities are not part of the fire control equipment.

(7) For instructions on the care and use of the off-carriage fire control and sighting equipment used with this carriage, refer to FM 4-15, and to Technical Manuals on specific items of fire control and sighting equipment.

c. (1) The combination of telescope mount M35 and telescope M31 forms the sighting element for aiming the gun in azimuth. The carriage has two telescope mounts and two telescopes, one for each side of the gun.

(2) The clinometer M1912 or M1912A1 and gunner's quadrant M1 or M1918 are used for measuring gun elevation. The clinometer M1912 is graduated in degrees, and the M1912A1 in mils; the gunner's quadrant is graduated in mils.

(3) The bore sights are used during the bore sighting operation for verification and alinement of the sighting and fire control equipment.

**39.2. Care and preservation.—a. General.—**(1) The instructions given below supplement instructions pertaining to individual instruments included in the following sections.

(2) The policy in regard to disassembly, repair, maintenance, and adjustment for all sighting and fire control instruments is as described below.

(a) Except as authorized in (b) below, disassembly and assembly of instruments by the using personnel are, in general, not permitted beyond the extent authorized in the paragraphs dealing with the individual instruments.

(b) In general, battery operating personnel are limited to adjustments, repairs, and maintenance which can be performed with the facilities available to them and which do not require access to the interior of the instrument through the removal of the cover plates. Adjustments, repairs, and maintenance which can be performed with the facilities available and which require access to the interior of the instrument through the removal of the cover plates may be performed

by local personnel, either of the using arm or of the Ordnance Department, who have been qualified for the work either through the successful completion of a recognized course of instruction in maintenance or through adequate experience in the type of operation to be undertaken. A recognized course of instruction is one that has the approval of the Chief of Ordnance and the Commanding General, Army Ground Forces. Determination of adequate experience in each case will be made by the responsible ordnance officer. The responsible ordnance officer will take the necessary action where maintenance requires facilities beyond those available locally.

(3) The maintenance duties described are those for which tools and parts have been provided the using personnel. Other replacements and repairs are the responsibility of maintenance personnel, but may be performed by the using arm personnel, when circumstances permit, within the discretion of the battery commander concerned.

b. (1) Fire control and sighting instruments are, in general, rugged and suited for the purpose for which they have been designed. They will not, however, stand rough handling or abuse. Inaccuracy or malfunctioning will result from such treatment.

(2) Unnecessary turning of screws or other parts not incident to the use of the instrument is forbidden.

(3) When placing instruments in or removing them from their carrying cases, avoid the use of force.

(4) When the instruments are not in use, keep them in the carrying cases provided or in the condition indicated for traveling.

(5) Keep the instrument as dry as possible. If the instrument becomes wet, dry it before placing it in its carrying case.

(6) Instruments which indicate incorrectly or fail to function properly after the authorized tests and adjustments have been made are to be turned in for repair by ordnance personnel.

(7) No painting of fire control or sighting equipment by the using personnel is permitted.

(8) Fire control mechanisms move freely and smoothly throughout the range of the instruments. The mechanisms must not be forced against the stops provided at the extremes of the range.

c. (1) Where lubrication with oil is indicated (par. 39.4h (3)) use oil, lubricating, for aircraft instruments and machine guns.

(2) Lubricants for fire control instruments also function as rust preventives. Lubricants must be applied carefully and diligently. Excessive lubrication must be avoided.

(3) The exterior of instruments must be kept free of dirt, dust, and seeping oil. Remove excess oil from metal or painted surfaces

with a cloth slightly moistened with solvent, dry-cleaning, and wipe the surface with a clean cloth.

d. (1) To obtain satisfactory vision, exposed surface of lenses and other optical parts must be kept clean and dry. Corrosion and etching of the surface of the glass can be prevented or greatly retarded by keeping the glass clean and dry.

(2) For wiping optical parts use only paper, lens, tissue. The use of cleaning cloths for wiping optical parts is not permitted. Do not wipe lenses or windows with the fingers. To remove dust, brush the glass lightly with a clean brush, camel's-hair. Rap the brush against a hard body to knock out the small particles of dust that cling to the hairs. Repeat this process until all dust is removed from the glass surface. An additional brush with coarse bristles is provided with some instruments for cleaning mechanical parts. Each brush should be used only for the purpose for which it is intended.

(3) Exercise particular care to keep optical parts free from grease and oil. To remove grease or oil from optical surfaces, apply soap, liquid, lens cleaning, with a tuft of lens paper. Wipe the surface gently with clean lens paper. If lens cleaning liquid soap is not available, breathe heavily on the surface and wipe it off with clean lens paper. Repeat this process until the surface is clean.

(4) Moisture may condense on the optical parts of the instruments when the temperature of the parts is lower than that of the surrounding air. The moisture, if not excessive, can be removed by placing the instrument in a warm place. Heat from strongly concentrated sources should not be applied directly as it may cause unequal expansion of parts, thereby resulting in breakage of optical parts or inaccuracies in observation.

**39.3. System, data transmission, M5 (on-carriage components).**—*a. Description.*—The on-carriage components of the data transmission system M5 consist of the azimuth indicator M6, the elevation indicator M5, the switch box and the junction box (fig. 173.2).

(1) The azimuth and elevation indicators receive four elements of data: coarse azimuth and fine azimuth; coarse elevation and fine elevation. The indicator dial for each of these four elements consists of an inner dial bearing a pointer index, an outer concentric ring bearing a similar pointer index, and a graduated scale. The inner dial is electrically driven by the corresponding transmitter element in the plotting room, and its pointer index shows the same scale reading as the plotting room transmitter. The outer concentric ring is geared to the traversing or elevating drive of the gun carriage, and its pointer index shows the actual azimuth or elevation of the gun. Hence, when

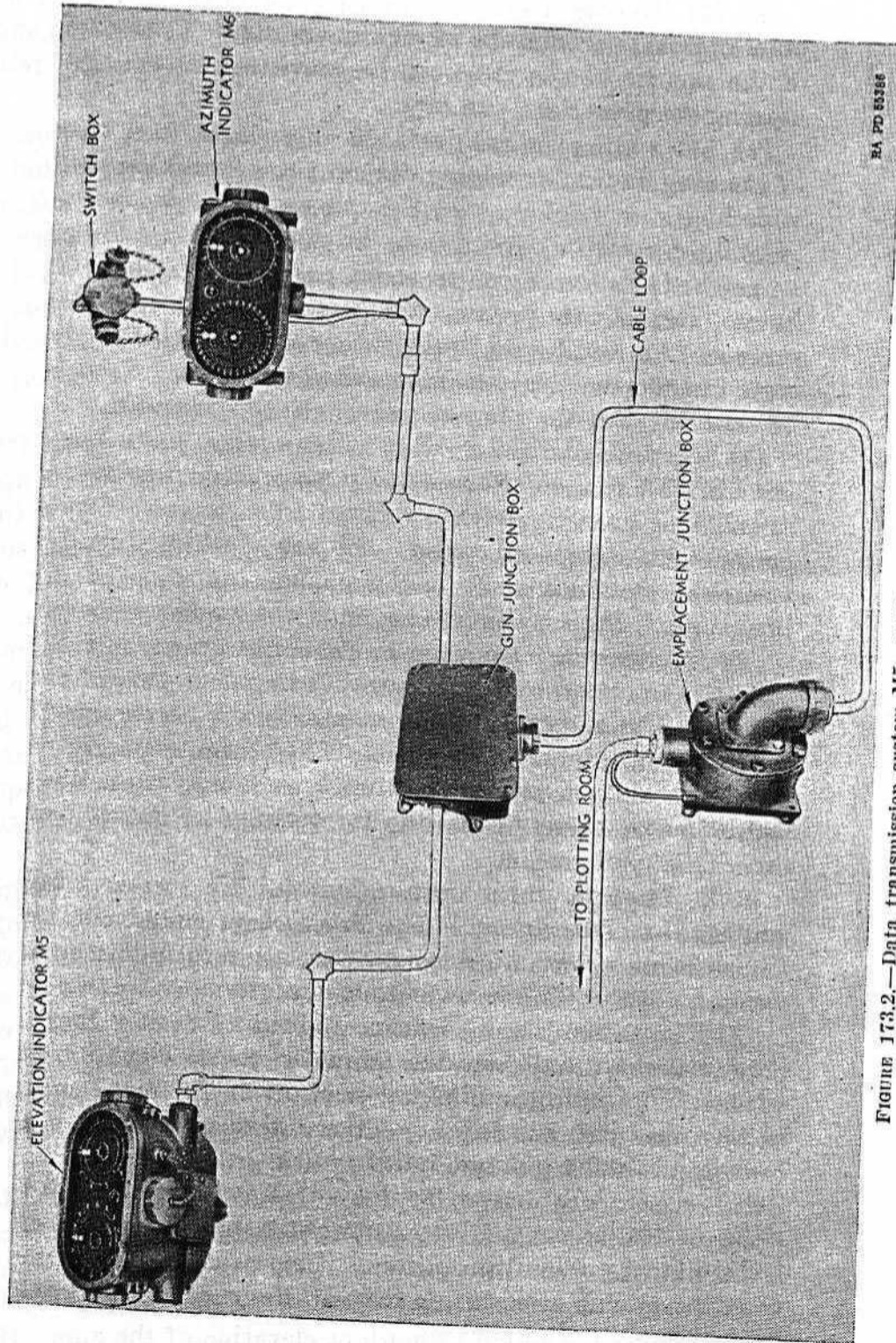
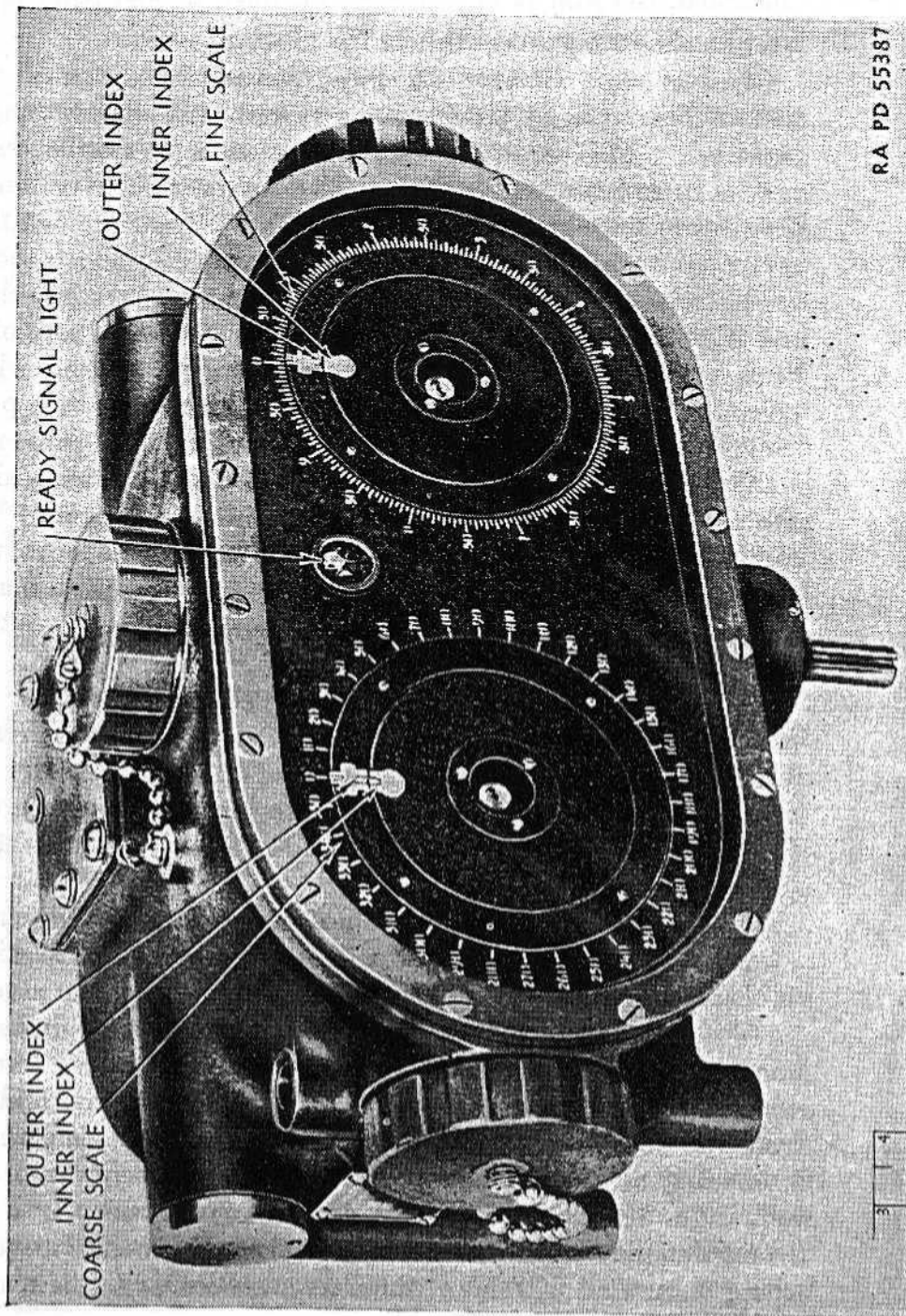

Figure 173.2.—Data transmission system M5—arrangement of cables for each gun.



RA PD 55387

FIGURE 173.3.—Azimuth indicator MG.



both the coarse and the fine inner and outer pointer indexes are matched, the gun is at the same azimuth or elevation as that which is set on the transmitter dials in the plotting room.

(2) For each element of data transmitted, an a-c synchronous transmitter, an a-c synchronous repeater, and connecting means are provided. The repeaters and transmitters resemble small electric motors in external appearance. The repeater follows the motion of the distant transmitter and synchronizes (lines up) with the transmitter when power is applied, regardless of relative position prior to application of power. The repeater cannot carry mechanical load, and is therefore used in connection with a "follow-the-pointer" drive. Each repeater carries only an index (electrical) with which another index (mechanical), connected to the element to be positioned, is brought into alinement by means of a handwheel or other drive.

(3) The azimuth indicator M6 (fig. 173.3) is mounted on the left side of the gun carriage. The coarse dial indicates  $360^\circ$  per revolution, and the fine dial indicates  $10^\circ$  per revolution. A ready signal lamp is mounted behind a red bull's-eye between the dials. The entire mechanism is inclosed in a weatherproof case provided with a shatterproof glass window.

(4) The elevation indicator M5 (fig. 173.4) is similar in construction to the azimuth indicator except that the unit of graduation of the dials is the mil instead of the degree. The coarse dial is graduated from 0 to 1,600 mils in 100-mil divisions and numbered every 100 mils. The fine dial is graduated from 0 to 100 mils in 1-mil divisions and numbered every 10 mils.

(5) A switch box (fig. 173.2) near the elevation indicator contains a trouble lamp receptacle and a toggle switch. The switch operates the electric lamps in the indicators for illuminating the indicator dials.

(6) On-carriage wiring is carried in metal conduits to the gun junction box, which is mounted in the lower rotating part of the gun carriage, above the emplacement well. A loop of flexible cable leads from the gun junction box to the emplacement junction box, which is mounted in a stationary position on the side of the emplacement well. The flexible cable loop permits free traverse of the carriage throughout the field of fire. From the emplacement junction box the wiring is carried by underground armored cable to the main junction box in the plotting room.

*b. Operation.*—(1) If possible, verify the adjustments before commencing operations. These adjustments are described in *d* below.

(2) At the guns, the traversing and elevating handwheel operators first match the pointer indexes on the coarse indicator dials and then

match the pointer indexes on the fine indicator dials. The operators keep the pointer indexes matched when the transmitted data changes. The ready signal lamps show when correct data signals are being transmitted.

(3) Operation of the system with the gun data computer is the same as described above, except that the azimuth and elevation transmitters are not used, the gun data computer being connected instead.

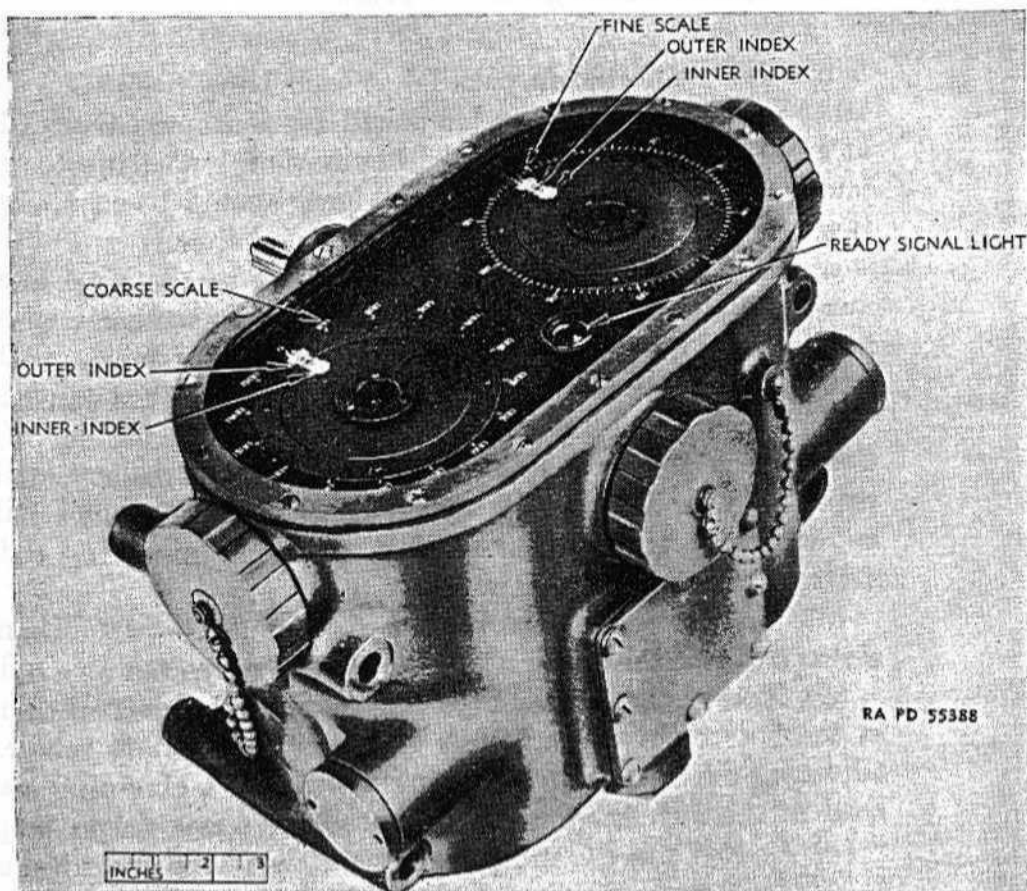

FIGURE 173.4.—Elevation indicator M5.

*c. Instructions for reading coarse and fine dials on indicators.*—The scale reading is the sum of the readings on the coarse and fine scales. When the coarse index indicates between two graduations on the coarse scale, the lower-numbered graduation is the one which is read. Thus, a coarse indication between  $40^{\circ}$  and  $50^{\circ}$ , together with a fine indication of  $5.15^{\circ}$  is read as  $45.15^{\circ}$ .

*d. Verification of adjustments.*—The following adjustments should be checked when possible before commencing operation:

(1) *Orientation.*—The outer dials on the azimuth and elevation indicators should indicate correctly the actual gun azimuth and elevation. Instructions for adjustment are given in *e* below.

(2) *Synchronization.*—The inner dials on the azimuth and elevation indicators should read the same as the corresponding transmitter dials when the system is energized. They should also read the same as the corresponding dials on the gun data computer. Instructions for adjustment are given in *f* below.

(3) *Ready signal lamps and indicator illuminating lamps.*—Two lamps are connected in parallel at each lamp position, so that if one lamp burns out the other lamp will remain operative. If the lamps at any position show reduced illumination, indicating that one of the lamps is burned out, the defective lamp should be replaced. Instructions for lamp replacement are given in *g* below.

*e. Orientation.*—(1) Orientation refers to the mechanical adjustment of the azimuth and elevation indicators so that when the gun is pointed in a given direction, the outer indexes for azimuth and elevation will indicate correctly the direction in which the gun is pointed.

(2) Each gun is oriented independently of the other. The instructions which follow are for one gun. Readjustment will seldom be required after the initial adjustment. Readjustment will, however, be required after any disassembly operations involving the indicator drives on the gun mount.

(3) *Orientation of azimuth indicator M6.*—(a) Using the bore sights traverse the gun until it is accurately directed on a datum point.

(b) Note that the zero adjusting device is located on the split gear at the bottom of the azimuth indicator drive shaft tube. The zero adjusting device has an adjusting worm and a clamping screw. The head of the adjusting worm is slotted for screw driver operation.

(c) Loosen the clamping screw and then turn the adjusting worm as required until the indicator scale reading (the combined reading of the coarse and fine scales) is the same as the known azimuth of the datum point. Tighten the clamping screw to retain the adjustment.

(4) *Orientation of elevation indicator M5.*—(a) Using the clinometer, set the gun to a convenient reference elevation. Any elevation can be chosen, but the gun must be set accurately to the chosen elevation.

(b) Note that the zero adjusting device is located on the shaft behind the elevation indicator. The zero adjusting device has an adjusting worm and a clamping screw. The adjusting worm and the clamping screw have knurled socket heads which can be operated either by hand or by use of a  $\frac{7}{32}$ -inch socket head set screw wrench.

(c) Loosen the clamping and then turn the adjusting worm as required until the indicator scale reading (the combined reading of the coarse and fine scales) is the same as the gun elevation. Tighten the clamping screw to retain the adjustment.

*f. Synchronization.*—(1) Synchronization is the adjustment of the indicator inner indexes to the same reading as the corresponding transmitter dials.

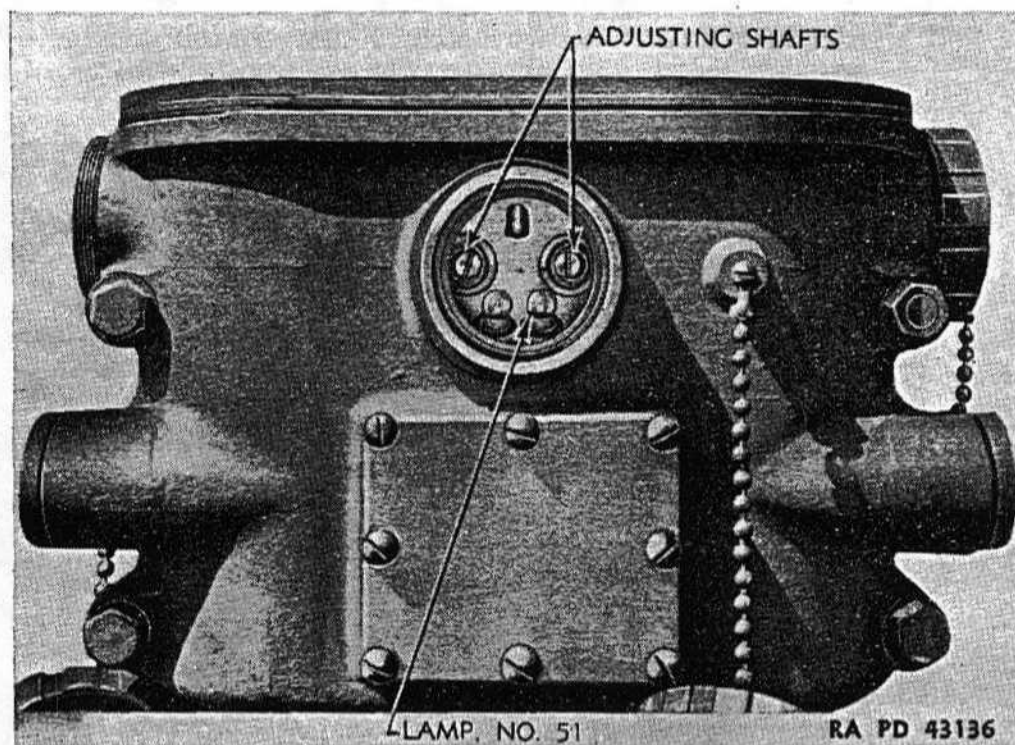

FIGURE 173.5.—Elevation indicator M5—ready signal lamps and synchronizing adjusting shafts.

(2) Synchronization is performed with the system energized. It will seldom be necessary to alter the synchronization adjustments, but the adjustments should be verified periodically.

(3) Slotted adjusting shafts for the coarse and fine indicator inner indexes are located under the indicator signal lamp cover (fig. 173.5). The motion of these shafts is limited to a few turns, sufficient to provide adjustment under all normal conditions. No attempt should be made to force a shaft if a stop is encountered.

(4) To synchronize the azimuth or elevation indicator, energize the system and note the readings of the coarse and fine transmitter output dials. By means of the slotted adjusting shafts, set the inner coarse and fine indexes to read the same as the corresponding transmitter output dials.

(5) Do not attempt to synchronize if the direction of rotation of any of the indicator inner indexes is reversed, or if there is a large departure from synchronism (often a multiple of  $60^\circ$ ). Such condition indicates a wiring fault which must first be determined and corrected.

(6) Synchronizing adjustments performed with the azimuth and elevation transmitters will normally hold also for the gun data computer. If the synchronizing adjustment changes when the gun data computer is connected in place of the azimuth and elevation transmitters, it will be necessary to adjust the transmitter elements in the

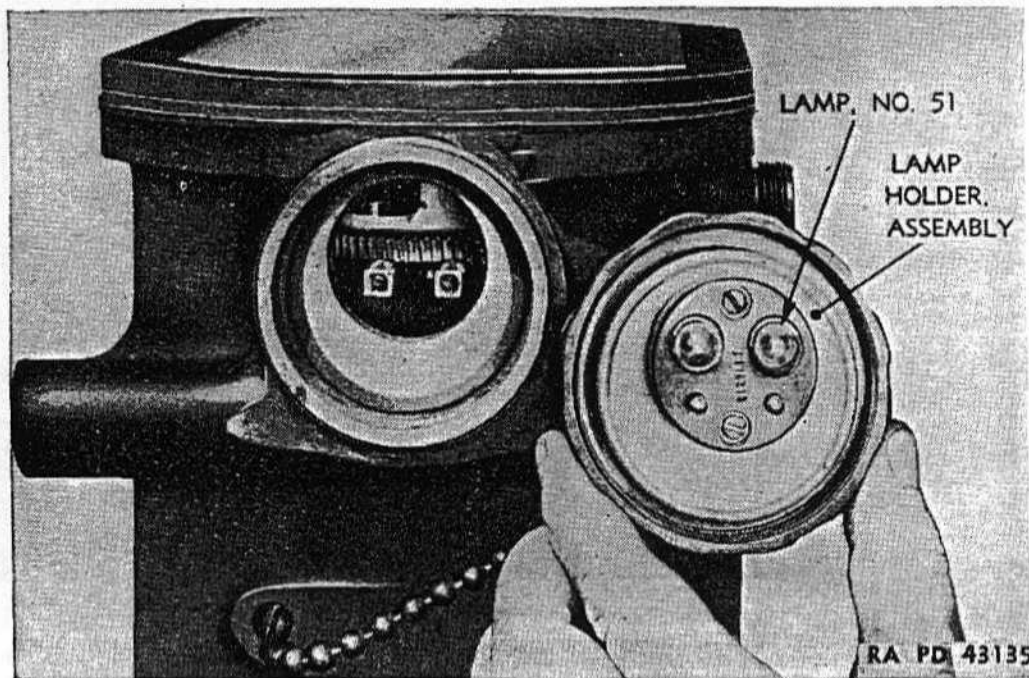

FIGURE 173.6—Elevation indicator M5—lamp holder, assembly.

transmitter to bring them into agreement with the corresponding transmitter elements in the gun data computer.

*g. Lamp replacement.*—Lamps used in the azimuth and elevation indicators are Mazda No. 51 type (1 cp, 6-8 volts, 0.2 ampere, G  $3\frac{1}{2}$  bulb). The lamps are accessible for lamp replacement after removal of the lamp well covers. (See figs. 173.5 and 173.6.)

*h. Care and preservation.*—(1) Power should be switched off before cables are connected or disconnected. See that cables are securely held in the receptacles before turning on the power.

(2) Do not kink or twist the cables. Avoid bending the cables on a short radius, or allowing them to chafe against moving parts. Keep

the cables clean of oil or grease. To remove oil or grease, wipe the area as clean as possible and then wash with soapy water.

(3) When the cables are not connected, keep plugs and receptacles closed with the covers provided to exclude dirt and moisture.

(4) When the cables are connected, keep the plugs and receptacles tightened firmly together by means of the round nuts. Screw the plug and receptacle covers together to keep them from dangling and to protect the threads.

(5) When disconnecting a cable, pull on the body of the plug. Do not pull on the cable or spring.

(6) The indicators and transmitters do not require lubrication when in service. Such lubrication as is required is performed in connection with major disassembly or overhaul.

(7) Should any repeater start to "run away" (run as a motor at a high rate of speed), cut off the power immediately and then reapply power after the repeater comes to rest. Repeaters are most likely to run away at the instant when power is applied.

(8) Should a repeater on either gun bind or stick during operation, turn off the power to that gun by means of the switch in the main junction box. A binding or sticking repeater will cause inaccurate transmission of data, and will be subject to overheating and possible burn-out. Refer to ordnance maintenance personnel for repair or replacement.

**39.4. Mount, telescope, M35, with telescope M31.—a. General.**—The telescope mounts M35 (fig. 173.7) are mounted on the right and left side of the carriage. The telescope M31 fits into the telescope mount. The combination of telescope mounts and telescopes forms the sighting element for aiming the gun in azimuth (case II pointing).

**b. Description of telescope mount M35.**—(1) The cradle of the telescope mount has clamps and locating surfaces for securing the telescope. The open sights at the top of the cradle provide a line of sight parallel to the telescope line of sight, and are used for rapid approximate aiming. The front sight can be folded down when not in use.

(2) The elevating knob of the telescope mount elevates or depresses the cradle and telescope.

(3) The deflection knob deflects the cradle and telescope in azimuth. Deflection motion is read in degrees and hundredths of degrees on the scale and micrometer. The deflection scale is calibrated from 0° to 20° in 1° intervals. The deflection micrometer is calibrated directly in hundredths of degrees. "Normal" deflection setting (line of sight parallel to axis of gun bore) is 10.00°.

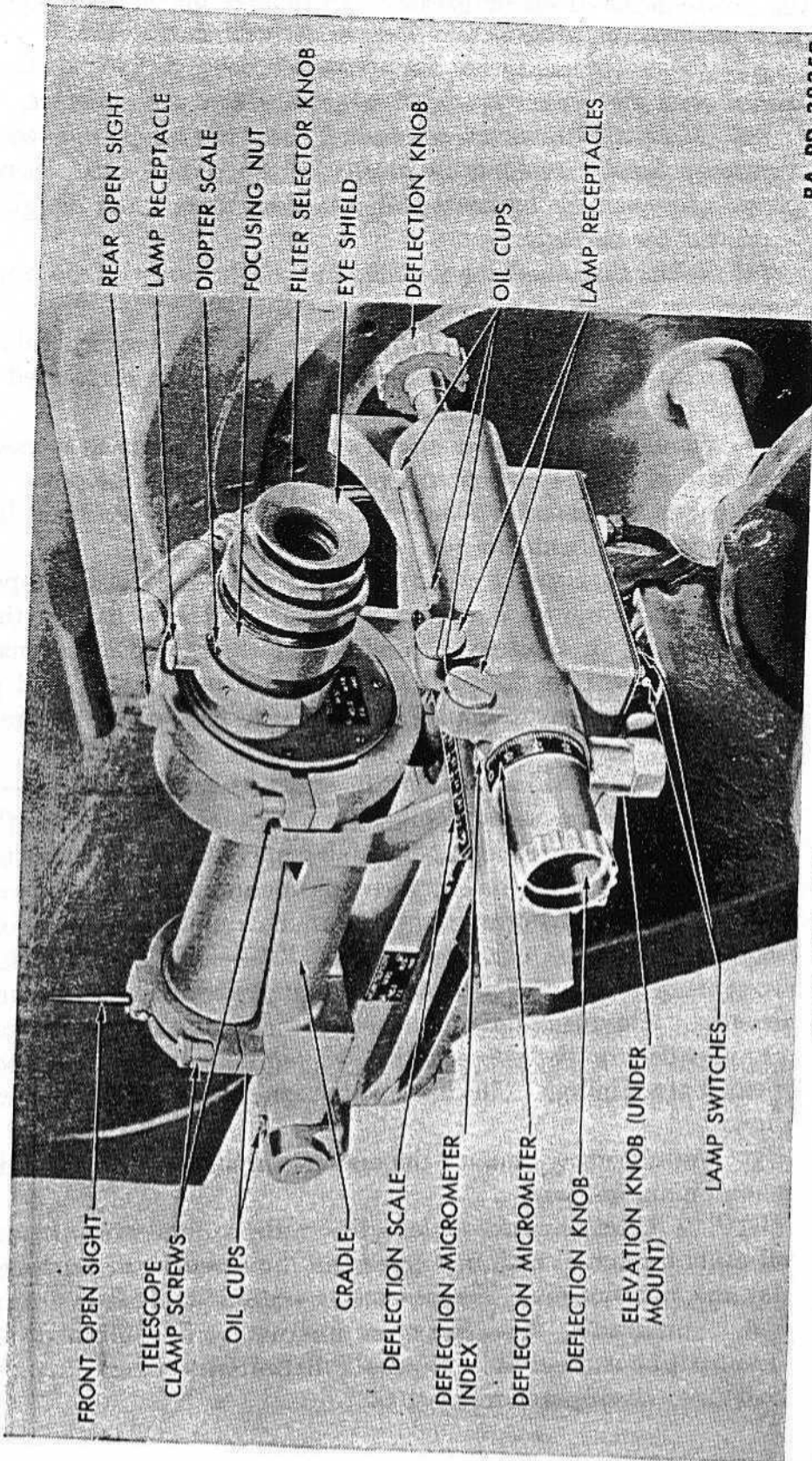

RA PD 38359

FIGURE 173.7.—Telescope mount M35, with telescope M31.

(4) Built-in electric lamps illuminate the deflection scale and micrometer of the telescope mount, and the reticle cross wires of the telescope. The lamp circuits are controlled by switches on the rear face of the telescope mount. A short interconnecting cable, which is furnished as an accessory, ties the telescope to the telescope mount.

*c. Description of telescope M31.*—(1) The telescope (fig. 173.7) has an 8-power magnification and a field of view of  $8^{\circ}45'$ .

(2) The eyepiece can be focused to meet eyesight variations of individual observers. The diopter scale on the eyepiece enables the observer to prefocus the telescope, if he knows his own eye correction.

(3) Amber, neutral, or clear filters can be introduced by use of the filter selector knob.

(4) The objective cap covers and protects the objective when the telescope is not in use.

*d. Preparing for operation.*—(1) Clamp the telescope in the cradle of the telescope mount. If illumination will be required, connect the cable between the telescope and telescope mount.

(2) Focus the telescope by turning the focusing nut until objects at target range appear sharp and clear. The observer should record the diopter scale setting for his future use. If the diopter scale setting is known, the telescope can be focused by simply bringing the scale to the known setting.

(3) Select the proper telescope filter according to the light conditions. Use the clear filter for dim light or for normal light with no glare. Use the amber or neutral filter to reduce glare. The neutral filter is most useful when observing into the direction of the sun.

*e. Operation, gun pointing.*—(1) Set the deflection scale and micrometer to the announced deflection by turning the deflection knob. If no deflection is required, set to  $10.00^{\circ}$ .

(2) Traverse the gun to bring the telescope to bear on the target. The open sights may be used initially to speed pointing. Use the elevating knob to bring the target onto the horizontal cross wire of the telescope reticle, then refine the gun traverse to place the target exactly at the intersection of the horizontal and vertical cross wires. This final operation points the gun in azimuth.

*f. Test and adjustment.*—At regular intervals depending on service conditions, the gun should be bore sighted to verify the alinement of the telescope and telescope mount. Procedure for bore sighting is as follows:

(1) Place the breech bore sight in the gun and stretch the black linen cord tightly across the muzzle, vertically and horizontally in the score marks on the muzzle.



(2) Use the bore sights to point the gun at a distant datum point, at or beyond midrange of the gun. Set the deflection scale and micrometer of the telescope mount to read  $10.00^\circ$  and observe the datum point through the telescope. Use the elevating knob, if necessary, to bring the datum point onto the horizontal cross wire of the telescope. If the adjustment is correct, the datum point will appear exactly on the vertical cross wire.

(3) If the adjustment is not correct, turn the deflection knob to bring the datum point onto the vertical cross wire. Adjust the deflection scale and micrometer to read  $10.00^\circ$  with the telescope in this position. To adjust the micrometer, loosen the three screws in the cupped end of the deflection knob to unclamp the micrometer, then turn the micrometer to zero reading and reclamp. To adjust the scale, loosen the screw at each end of the scale and shift the scale to bring the "10" graduation in register with the index, then reclamp.

*g. Lamp replacement.*—The electric lamps are mounted in individual lamp receptacles which are removable to permit lamp replacement. The lamps are the same type as those used in the azimuth and elevation indicators. To remove the lamp receptacle, loosen the small headless clamping screw (using the jeweler's screw driver provided) in the edge of the receptacle and then unscrew the receptacle.

*h. Care and preservation.*—(1) Refer to paragraph 39.2 for general care and preservation instructions.

(2) Keep the objective cap in place whenever the telescope is not in use. During idle periods, store the telescope in the carrying case provided.

(3) Lubricate the telescope mount occasionally by applying a drop of oil, lubricating, for aircraft instruments and machine guns, in each of the six oil cups. Lubricate sparingly. Wipe off any excess lubricant to prevent accumulation of dust and grit.

[A. G. 300.7 (10 Jul 43).] (C 1, 15 Sep 43.)

BY ORDER OF THE SECRETARY OF WAR:

G. C. MARSHALL,  
*Chief of Staff.*

OFFICIAL:

J. A. ULIO,  
*Major General,*  
*The Adjutant General.*

**16-INCH SEACOAST GUN MATERIEL  
GUN MK. II M1; BARBETTE CARRIAGE M4**

Prepared under the direction of the  
Chief of Ordnance.

**TABLE OF CONTENTS**

	Paragraphs	Pages
SECTION I. Introduction .....	1-4	2-11
II. Description and functioning .....	5-8	12-151
III. Operation .....	9-10	152-191
IV. Care and preservation .....	11-19	192-201f
V. Inspection and adjustment .....	20-23	202-208
VI. Malfunctions and corrections .....	24-27	209-215
VII. Disassembly and assembly of gun, carriage and rammer .....	28	216
VIII. Electrical equipment .....	29-39	217-268
IX. Sighting and fire-control equipment (Data to be supplied when avail- able) .....		269
X. Ammunition .....	40-59	270-285
XI. Spare parts and accessories .....	60-88	286-307
XII. Materiel affected by gas (decontami- nation) .....	89-91	308-310
XIII. Artillery, seacoast: pressure testing..	92-96	311-312
XIV. Storage .....	97	313
XV. List of references .....	98-102	314-315
INDEX .....		316-323

16-INCH SEACOAST GUN MATERIEL  
GUN MK. II M1; BARBETTE CARRIAGE M4

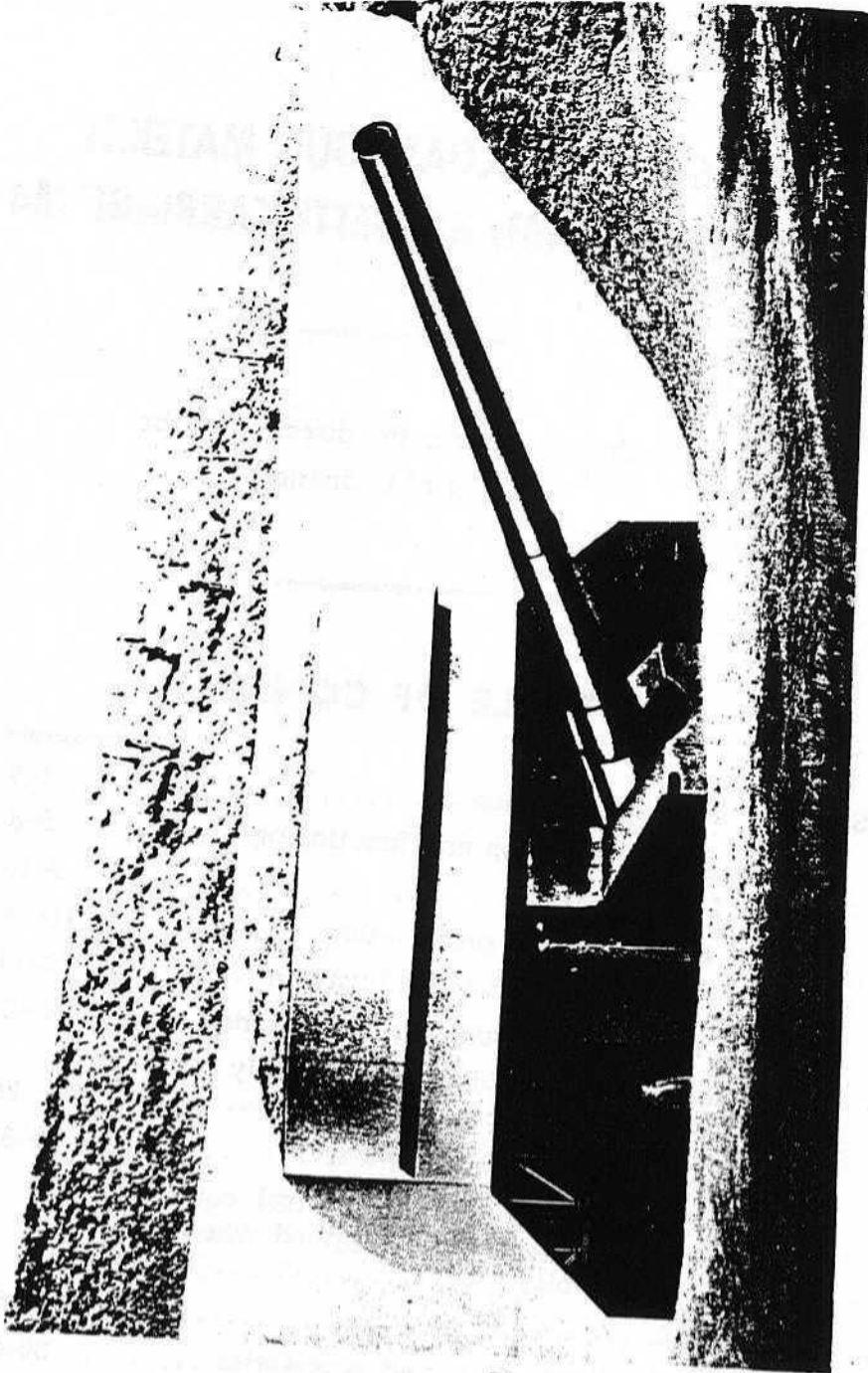

THE SHIELD SHOWN IN FIG. 1 IS THE FORGED STEEL SHIELD FOR THE 16 IN. BARBETTE CARRIAGE 1919 M3 GUN. THE SHIELD FOR THE M4 MOUNT IS CAST AND HAS THE CORNERS AND SURFACES ROUNDED.

RA PD 38669

Figure 1—16-inch Seacoast Gun, Mount in Casemate

Figure 1—16-inch Seacoast Gun, Mount in Casemate

TM 9-471

16-INCH SEACOAST GUN MATERIEL  
GUN MK. II M1; BARBETTE CARRIAGE M4

RA PD 38670

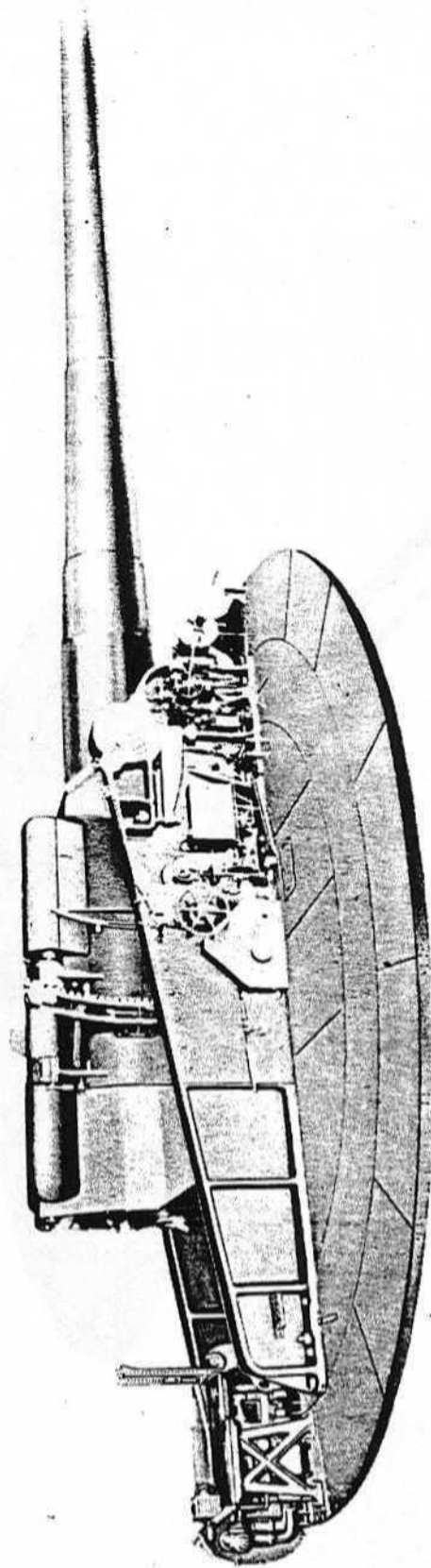

Figure 2—16-inch Seacoast Gun, Mk. II M1, Right Side View—  
Gun at Zero Elevation—Rammer in Place

16-INCH SEACOAST GUN MATERIEL  
GUN MK. II M1; BARBETTE CARRIAGE M4

RA PD 38671

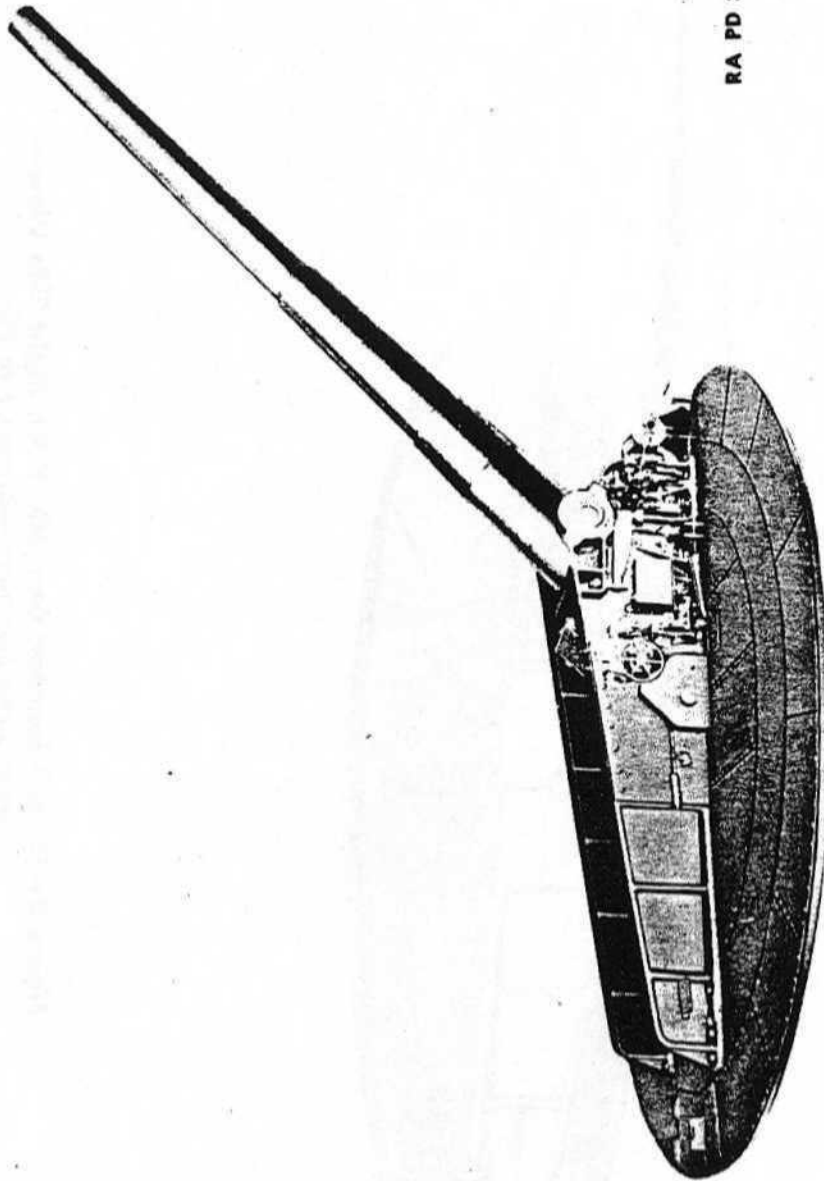
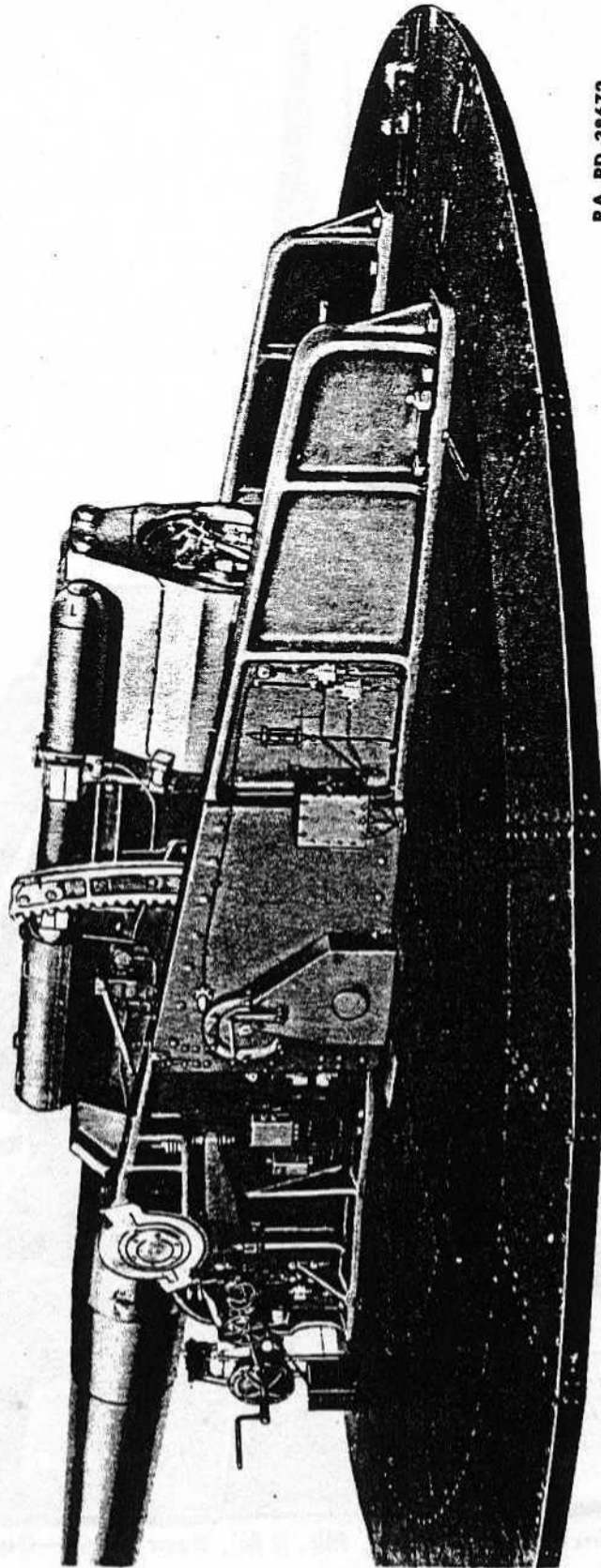

Figure 3—16-inch Seacoast Gun, Mk. II M1, Right Side View—  
Gun at 46 Degrees Elevation

16-INCH SEACOAST GUN MATERIEL  
GUN MK. II M1; BARBETTE CARRIAGE M4

Figure 3—10-inch Seacoast Gun, Mk. II M1, Right Side View—  
Gun at 46 Deg Elevation



RA PD 38672

Figure 4—16-inch Seacoast Gun, Mk. II M1, Left Side View

16-INCH SEACOAST GUN MATERIEL  
GUN MK. II M1; BARBETTE CARRIAGE M4

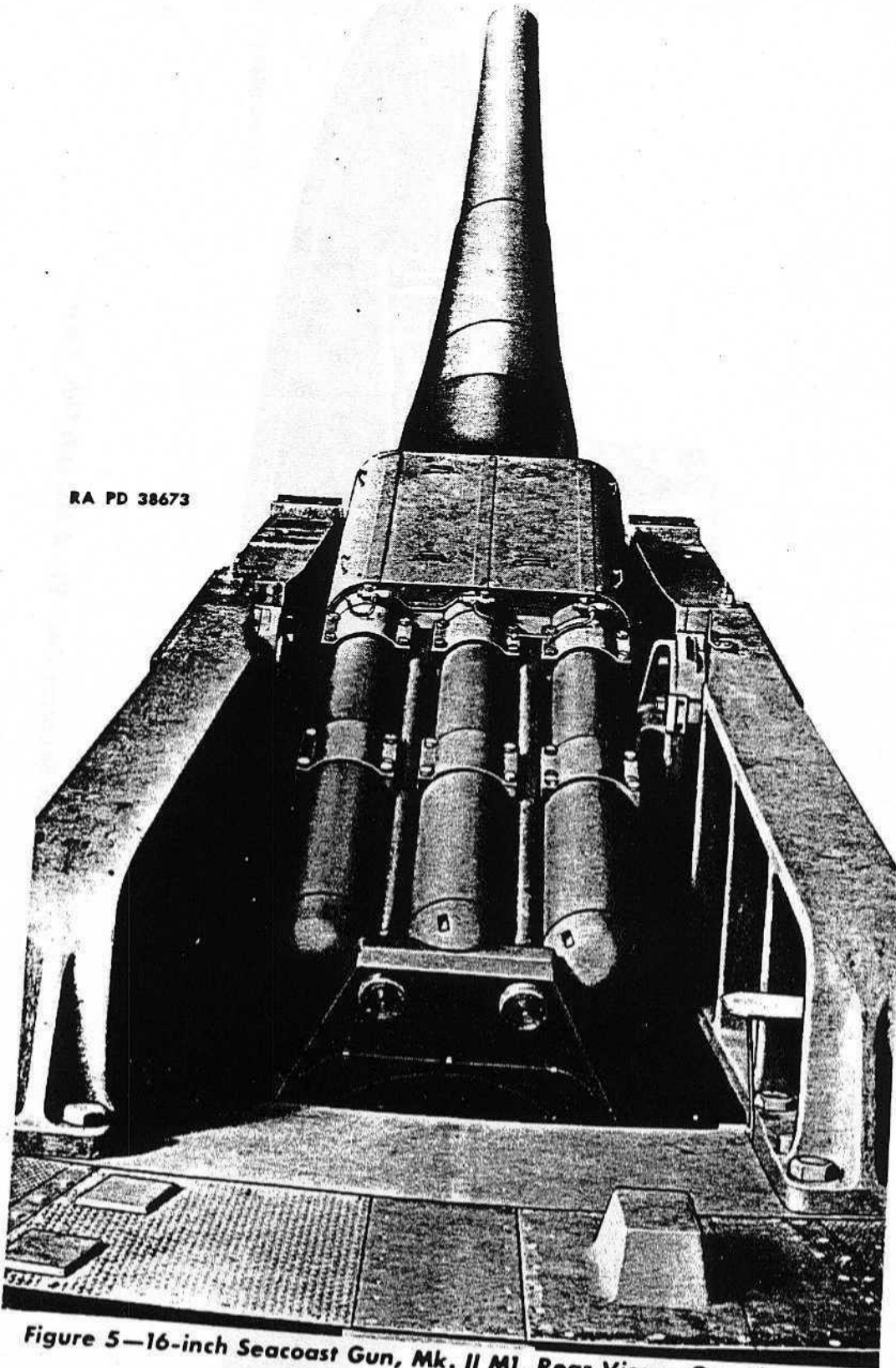

RA PD 38673

Figure 5—16-inch Seacoast Gun, Mk. II M1, Rear View—Gun Elevated

Scope  
Chara  
Differ  
Data

1. 8  
 a.  
 chara  
 use a  
 series

b.  
 Carri  
 Barb

c.  
 unde

d.  
 ment

prov

2.  
 a.  
 consi  
 16-in  
 16-in  
 16-in  
 Ar

b.  
 men  
 bom

c.  
 gur.

3.  
 a.  
 Car  
 Car  
 desig

1  
 ue

## Section I

**INTRODUCTION**

	Paragraph
Scope .....	1
Characteristics .....	2
Difference in models .....	3
Data .....	4

**1. SCOPE.**

a. This manual contains all the essential information of a technical character required by the using arms and services for the identification, use and care of the weapon, ammunition, and spare parts and accessories; but does not include the sighting and fire-control equipment.

b. This technical manual is intended to cover only 16-inch Barbette Carriage, M4 materiel. See section XV for publications covering 16-inch Barbette Carriage M1919, M1919M1, M2 and M3.

c. Disassembly, assembly and repairs by battery personnel will be undertaken only under the supervision of an officer or ordnance mechanic.

d. In cases where the nature of the repair, modification or adjustment is beyond the scope and/or facilities of the battery personnel, the local or otherwise designated ordnance service will be informed in order that trained personnel with suitable tools and equipment may be provided.

**2. CHARACTERISTICS.**

a. The 16-inch Barbette Carriage gun materiel M4 described herein consists of the following units:

16-inch Gun Mark II Navy design.

16-inch Gun Cradle and Recoil Mechanism Navy design.

16-inch Barbette Carriage (exclusive of cradle and recoil mechanism) Army design.

b. The materiel is of the Seacoast type, set in a permanent emplacement and protected by a metal shield against aerial, land or naval bombardment.

c. The casemate design of emplacement limits the elevation of the gun as well as the degree of traverse of the rotating parts.

**3. DIFFERENCE IN MODELS.**

a. The 16-inch Barbette Carriage M4 is a modification of Barbette Carriage model 1919. The previous modifications to the M1919 Barbette Carriage are designated M1919M1, M2 and M3. The variations in design and construction are substantially as follows:

(1) The model 1919 carriages, Serial Nos. 1 to 6 inclusive, Class 11, Division 16, have 360 degrees traverse, 65 degrees elevation and minus 7 degrees depression. They are equipped with Army design cradles and



**16-INCH SEACOAST GUN MATERIEL  
GUN MK. II M1; BARBETTE CARRIAGE M4**

recoiling parts and are mounted with 16-inch Army guns, model 1919M2 and M3. Carriages Nos. 1, 2, 3 and 6 have been equipped with four-inch cast shields. Casemate emplacements limit their traverse to 145 degrees, with 46 degrees elevation and minus 3 degrees depression. Carriages Nos. 4 and 5 have been equipped with two-inch tunnel type shields permitting 360 degrees traverse. They are limited to 46 degrees elevation and minus 3 degrees depression.

(2) Carriages Nos. 7, 8, 9, 11, 12 and 13 are designated as 16-inch Barbette Carriage model 1919M1 and are designed and manufactured in accordance with Class 11, Division 28, ordnance drawings and specifications. They are designed for 360 degrees traverse and have a maximum elevation of 55 degrees and depression of minus 7 degrees. They are not provided with shields.

(3) Carriages Nos. 10, 14, 15 and 16 are designated as 16-inch Barbette Carriage M2. These are casemate mounts provided with two-inch shields. They have a maximum elevation of 47 degrees and 0 degrees depression. They are provided with 360 degrees azimuth circles and traversing racks, their traverse being limited to 145 degrees by the type of emplacement. For the ammunition service, hand trucks or overhead trolleys are used. The carriages have modified type ammunition tables and rammer controls and in these respects they differ from the model 1919 and 1919M1 carriages.

(4) Carriages Nos. 17 and 18 are designated as 16-inch Barbette Carriage M3 having a maximum elevation of 47 degrees and 0 degrees depression. The M3 carriage is practically the same as the M2 excepting that in addition to the special features pertaining to the M2 carriage it is provided with a new type of elevation buffer (lowered 18 in.) and is also provided with heavier floor beams. These carriages have a two-inch shield and 360 degrees azimuth circles and traversing racks. Their traverse is limited to 145 degrees by the type of emplacement.

(5) All carriages after No. 6 have Navy designed cradles and recoiling parts and are mounted with Navy guns. The side frames and recoiling parts, including the recoil and recuperator mechanisms, differ from the first six carriages manufactured.

(6) The 16-inch Barbette Carriage M4 (figs. 1, 2, 3, 4 and 5) is designed and manufactured in accordance with Ordnance Department drawings Class 11, Division 38 and differs in many respects from the previously designed 16-inch Barbette Carriage materiel.

(7) The M4 carriage carries a four-inch cast shield. It is provided with an elevation data receiver and has no elevating range disk, depending on the elevation data receiver for correct elevation data.

(8) The mount is designed for maximum elevation of 46 degrees with minus elevation of 3 degrees. Modified elevating racks to afford shield clearance and to provide for other special conditions governing elevation are provided.

(9)  
the rig  
of 145  
equipm  
rotat  
cover  
degree  
All me  
gradue

(10)  
proved  
modifi  
data r  
scopic  
bearin  
cast sl  
a rede

4. D  
a.  
includ

Weight  
Calibe  
Lengt  
Lengt  
Weight

Weight

Weight  
Mk  
Cham

Muzz

Range

Trave  
Capac  
Riflin

Len

u

.u1

Tw

INTRODUCTION

(9) The maximum traverse of the mount is 72 degrees 5 minutes to the right and left of the center line of fire or a total permissible traverse of 145 degrees. It is provided with an azimuth data receiver and special equipment for correctly recording the azimuth readings as the mount is rotated to the right or left. The traversing racks on the M4 carriages cover only 180 degrees of the base ring circumference instead of 360 degrees as in the case of model 1919 and 1919M1, M2 and M3 carriages. All mounts after No. 20 will have a shorter azimuth circle which will be graduated only to cover the limited range of traverse of the mount.

(10) The M4 carriage is provided with practically all of the improved features of the M2 and M3 carriages and, in addition, has a modified type of rammer. It is also provided with elevation and azimuth data receivers, new type lighting and firing equipment, new type telescopic sights, new design of cradle trunnion providing for trunnion roller bearings (being considered for future units) and a new type of four-inch cast shield. It has modified air compressors and piping arrangement and a redesigned lubrication system.

4. DATA.

a. The following weights, dimensions, ballistics and other data are included herein for the information of all concerned.

b. 16-inch Gun, Navy Mk. II with Breech Mechanism Navy Mk. I.

Weight of gun with band	307,185 lb
Caliber	16 in.
Length of bore	50 cal
Length (muzzle to rear face of breech ring)	816 in. (68 ft)
Weight of gun (without band)	285,985 lb
Weight of projectile	{ Mk XII, A.P. . . . . 2,240 lb
	{ Mk II M2, A.P. . . . . 2,100 lb
Weight of powder charge (for both Mk XII and Mk II M2, full charge)	672 lb
Chamber pressure	38,000 lb per sq in.
Muzzle velocity	{ Mk XII projectile . . . . . 2,650 ft per sec
	{ Mk II M2 projectile . . . . . 2,750 ft per sec
Range (46° elevation)	{ Mk XII projectile . . . . . 45,100 yd
	{ Mk II M2 projectile . . . . . 44,670 yd
Travel of projectile in barrel	681.68 in.
Capacity of powder chamber	30,000 cu in.
Rifling:	
Length	675.992 in.
Number of grooves	96
Number of lands	96
Twist	Right-hand—uniform 1 turn in 32 cal

919M2  
16-inch  
degrees,  
as Nos.  
mounting  
minus

6-inch  
used in  
specifica-  
tion  
re not

Bar-  
16-inch  
degrees  
and  
type  
head  
ables  
model

bore  
degrees  
mounting  
ge it  
and is  
inch  
trav-

coil-  
coil-  
room

5)  
mount  
the

ded  
nd-

ees  
ord  
in

**16-INCH SEACOAST GUN MATERIEL  
GUN MK. II M1; BARBETTE CARRIAGE M4**

**c. 16-inch Barbette Carriage M4.**

Weight of carriage without shield.....	665,315 lb
Weight of shield (4-in. cast) estimated.....	200,000 lb
Weight of gun with band.....	307,185 lb
Total dead load on emplacement.....	1,172,500 lb
Weight of recoiling parts including gun and band.....	316,853 lb
Weight of tipping parts including gun and band.....	385,377 lb
Weight of tipping parts not including gun and band.....	78,192 lb
Weight of base ring and stationary parts.....	186,426 lb
Weight of traversing parts.....	986,074 lb
Weight of air compressor.....	4,200 lb
Traverse .....	145 deg
Maximum elevation .....	46 deg
Maximum depression .....	3 deg
Normal recoil .....	48 in.
Maximum recoil .....	49 in.
Rod pull .....	1,284,499 lb
Trunnion pull .....	1,052,769 lb
Capacity of recoil cylinder.....	73 gal
Normal air pressure in recuperator.....	1,700 lb per sq in.
Final air pressure in recuperator.....	3,090 lb per sq in.
Normal liquid pressure in recuperator.....	1,824 lb per sq in.
Final liquid pressure in recuperator.....	3,348 lb per sq in.
Liquid pump pressure.....	2,500 lb per sq in.
Blow-off pressure.....	2,200 to 2,500 lb per sq in.
<b>Recoil Cylinder Expansion Chamber:</b>	
Normal oil pressure.....	500 lb per sq in.
Capacity .....	2.6 gal
<b>Elevating mechanism right side, one turn of handwheel</b>	
counterclockwise elevates gun.....	56.509 min
<b>Elevating mechanism left side, one turn of crank</b>	
counterclockwise elevates gun .....	2 deg 56.897 min
One turn of slow-motion handwheel traverses gun.....	0.1098 deg
One turn of traversing crank traverses gun.....	1.5384 min

**Effort Required to Elevate the Gun with One-half Load in Breech**

	Applied to Crank	Applied to Handwheel
at zero elevation	60 lb	20 lb
at 23° elevation	100 lb	45 lb
at 46° elevation	200 lb	65 lb

at zero  
at 23°  
at 46°

at zero  
at 23°  
at 46°

NO  
pressio  
handv  
also a  
when

d.  
is loa  
powd  
insert  
its pr  
ts  
band

e.  
the a  
of as  
in ter

**INTRODUCTION**

**Effort Required to Depress the Gun with One-half Load in Breech**

	Applied to Crank	Applied to Handwheel
at zero elevation	80 lb	32 lb
at 23° elevation	7 lb	5 lb
at 46° elevation	0	0

**Effort Required to Elevate the Gun Unloaded**

	Applied to Crank	Applied to Handwheel
at zero elevation	155 lb	67 lb
at 23° elevation	230 lb	76 lb
at 46° elevation	280 lb	112 lb

**NOTE:** The forces required to initiate movement in elevation or depression of the gun when applied to the elevating crank or elevating handwheel vary with the angle of elevation of the gun. These forces are also affected by the weight of the projectile and powder in the breech when the gun is loaded.

d. The gun is in balance at level position (zero elevation) when it is loaded with a weight equal to one-half the weight of the normal powder charge plus one-half the weight of the projectile. This weight is inserted in the breech in such position as to simulate the projectile and its propelling charge. When unloaded the gun is muzzle-heavy at all points of elevation. It will depress by gravity with no measurable force applied to the elevating crank or handwheel when the elevating brake band is released.

e. The effort required to elevate and depress the gun as outlined in the above tabulation was determined by shop tests made at the time of assembling the parts. These efforts will vary as a result of changes in temperature and for other reasons.

**16-INCH SEACOAST GUN MATERIEL  
GUN MK. II M1; BARBETTE CARRIAGE M4**

**Section II**

**DESCRIPTION AND FUNCTIONING**

	Paragraph
Description and functioning of gun .....	5
Description and functioning of carriage .....	6
Description and functioning of rammer .....	7
Safety precautions .....	8

**5. DESCRIPTION AND FUNCTIONING OF GUN.**

a. The gun (fig. 6) consists of tube, liner, jacket, hoops, rings (fig. 7), recoil band (fig. 8) and the breech mechanism with closing cylinder and gas ejector systems.

(1) **GUN KEY.** The gun is provided with a stake-in key (fig. 6) attached to its upper surface which slides through a keyway in the cradle and prevents rotation of the gun during recoil and counterrecoil.

(2) **AUTOMATIC ELEVATING STOPS.** To prevent elevation or depression of the gun beyond prescribed limits automatic devices are provided. These consist of projections near the upper and lower ends of the elevating racks which engage with a buffer lever (W, fig. 87) on the right side frame and a buffer lever (H, fig. 88) on the left side frame. When the limits of elevation or depression are reached the stops on the elevating racks come into contact with elevating buffers preventing further elevation or depression of the gun.

(3) **BREECHBLOCK.** The breechblock (T, fig. 9) and (fig. 10) is of the interrupted-step-thread design and is so constructed as to enter the breech recess easily and quickly where it is locked in place by a rotary motion of the block. This rotary motion is effected by means of a system of rotating cams and rollers attached to the gun breech and breechblock (figs. 10, 11, 12 and 13). The action of opening or closing the block automatically engages or disengages the threads of the block from the threads of the breech recess. The block is provided with an obturator spindle (J, fig. 11), obturator nut (G, fig. 11), obturator spring (H, fig. 11), dummy pressure plugs (L, fig. 11), pressure plug washers (K, fig. 11), front ring (E, fig. 11), rear ring (B, fig. 11), inner ring (C, fig. 11) and gas check pad (D, fig. 11). The end of the obturator spindle is designed to receive the firing lock.

(4) **ROTATING CAM (UPPER).** A rotating cam (upper) (fig. 14), which houses the salvo latch, is located on the upper left-hand surface of the gun breech against which a roller (N, fig. 13), connected to the breechblock, operates to rotate the block. The block carrier is raised or lowered in the operation of closing or opening the breech.

DESCRIPTION AND FUNCTIONING

RA PD 38674

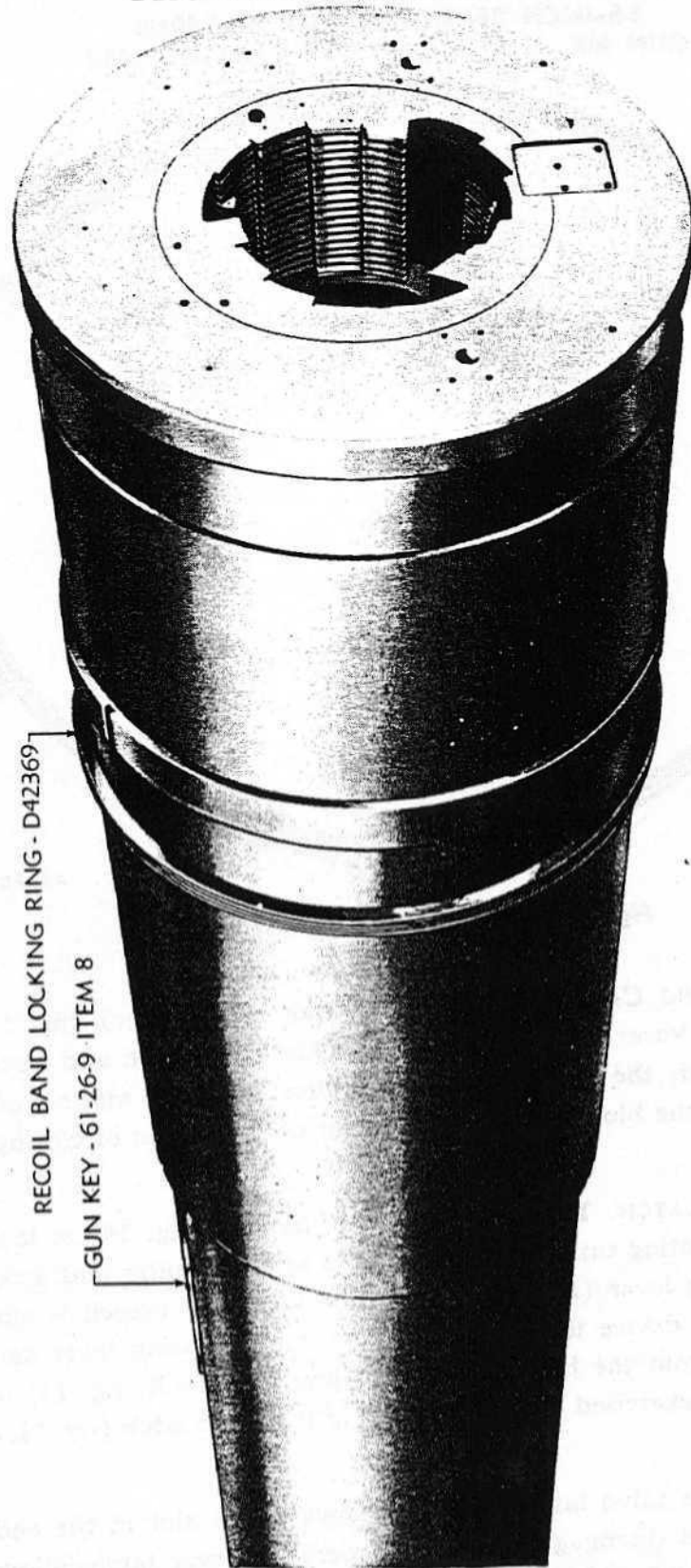

Figure 6—16-inch Seacoast Gun-barrel—Rear View

Paragraph  
 .. 5  
 .. 6  
 .. 7  
 .. 8

ings (fig. cylinder

(fig. 6) ne cradle

depres-  
 rovided.  
 e elevat-  
 g de  
 he... the  
 levating  
 r eleva-

is of the  
 after the  
 rotary  
 system  
 block  
 block  
 om the  
 turator  
 H, fig.  
 K, fig.  
 ig. 11)  
 dle is

g. 14), urface to the se

16-INCH SEACOAST GUN MATERIEL  
GUN MK. II M1; BARBETTE CARRIAGE M4

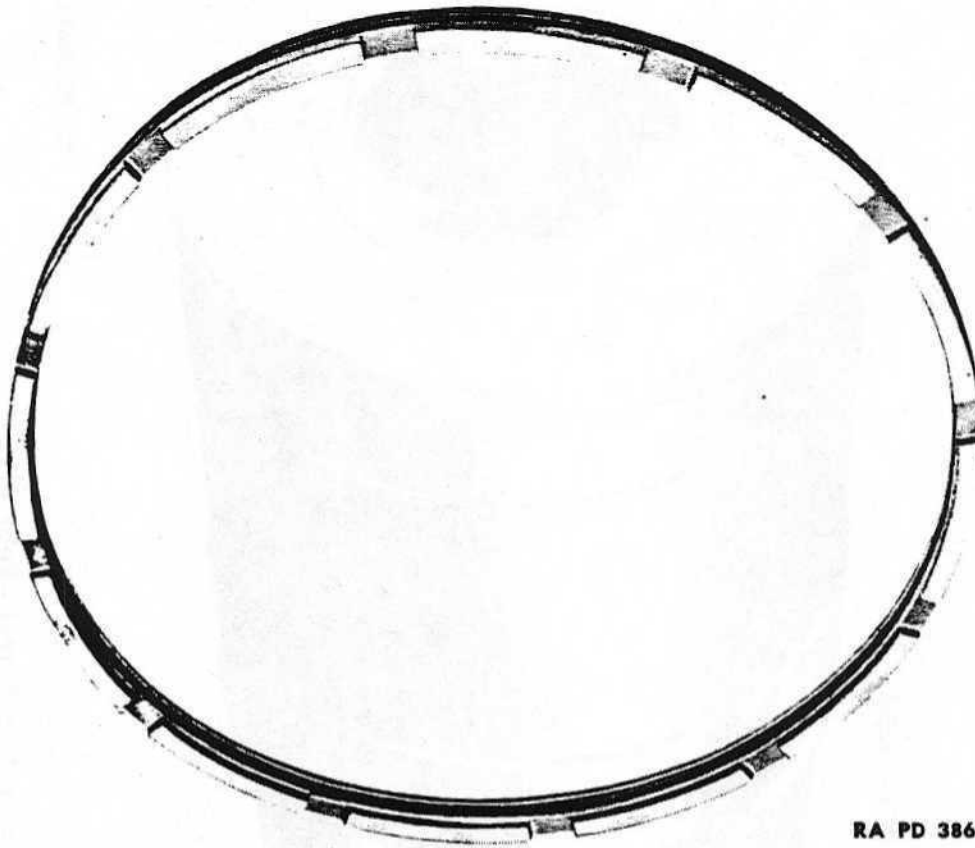

RA PD 38675

**Figure 7—Recoil Band Locking Ring**

(5) **ROTATING CAM (LOWER).** A rotating cam (lower) (fig. 15) is attached to the lower right-hand surface of the gun breech and works in conjunction with the upper cam to produce a rotary motion of the breechblock as the block carrier is raised in the operation of closing the breech.

(6) **SALVO LATCH.** The salvo latch mechanism (fig. 14) is located in the upper rotating cam. Its function is to act as a buffer and lock the breech operating lever (E, fig. 20) in place when the breech is closed. The salvo latch device is so designed that the operating lever cannot be disengaged from the breech operating lever latch (X, fig. 14) until hand pressure is exercised against the face of the salvo latch (fig. 12, and V, fig. 14).

(a) When the salvo latch is pressed inward, the slot in the end of the salvo latch is disengaged from the operating lever latch, allowing the operating lever latch to be raised. The raising of the operating lever latch releases the operating lever.

(b,  
preve  
being  
fig. 1

(c,  
preve  
This  
in co  
plun  
(B, f

(d  
v  
...ng  
block

## DESCRIPTION AND FUNCTIONING

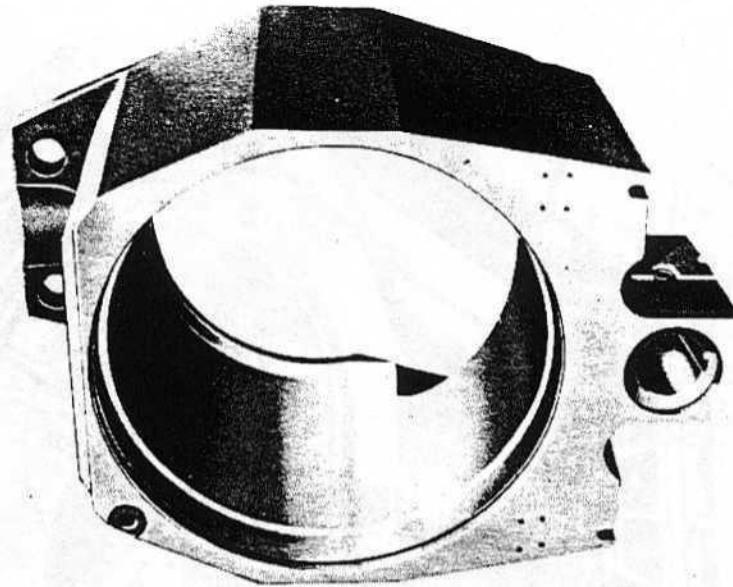

**Figure 8—Recoil Band—Dismounted**

(b) A latch locking screw (L, fig. 14) is assembled in the cam to prevent rotation of the salvo latch and also to prevent the latch from being forced too far outward by pressure of the salvo latch spring (U, fig. 14).

(c) The mechanism is provided with a hydraulic cylinder which prevents undue shock to the parts when the breechblock is being closed. This device also provides a means for holding the breech operating lever in contact with the operating lever latch. It contains a lever buffer plunger (C, fig. 14), plug (J, fig. 14), gland (A, fig. 14) and packing (B, fig. 14) to prevent leakage of the liquid from the cylinder.

(d) The upper end of the breech operating lever is drilled to receive a lever catch (B, fig. 20) and spring, which are in contact with the operating lever latch (X, fig. 14) in the salvo mechanism when the breechblock is completely closed.



16-INCH SEACOAST GUN MATERIEL  
GUN MK. II M1; BARBETTE CARRIAGE M4

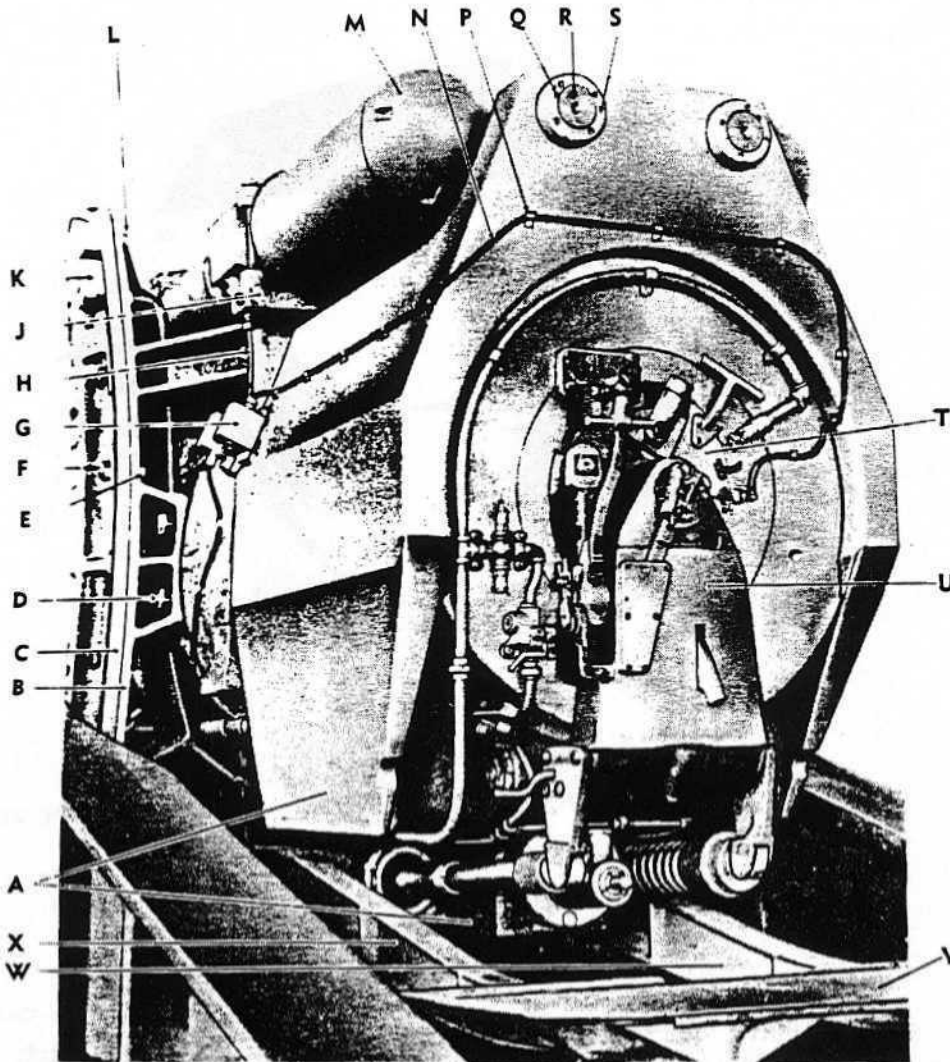

BREECH  
BUSHING

- |  |   |
|--|---|
| <p>A — RECOIL BAND D42366</p> <p>B — LEFT ELEVATING RACK BRACKET D42365B</p> <p>C — LEFT ELEVATING RACK</p> <p>D — BOLT A1488 AND NUT BBAX3D</p> <p>E — NUT BBAX3D</p> <p>F — BOLT B637</p> <p>G — FIRING CONTACTOR 14-5-86</p> <p>H — AIR MANIFOLD TUBING ASSEMBLY B187292</p> <p>J — AIR MANIFOLD ASSEMBLY</p> <p>K — LEFT ELEVATION STOP B162386 B</p> <p>L — BOLT B162404 AND NUT BBAX3D</p> <p>M — RECUPERATOR CYLINDER ASSEMBLY D42398</p> | <p>N — FIRING CIRCUIT CABLE (TWO-CONDUCTOR #14 STANDARD RUBBER COVERED)</p> <p>P — SINGLE CABLE CLAMP A217813 AND SCREW BCAX1BA</p> <p>Q — SET SCREW A218234</p> <p>R — RECUPERATOR YOKE ROD C87189</p> <p>S — (RECUPERATOR YOKE ROD) NUT B187207</p> <p>T — BREECHBLOCK 61-26-61 ITEM 1</p> <p>U — BREECHBLOCK CARRIER 61-26-62 ITEM 1</p> <p>V — LOADING PLATFORM D42368</p> <p>W — RIGHT LOADING PLATFORM BEAM D42394A</p> <p>X — LEFT LOADING PLATFORM BEAM D42394B</p> |
|--|---|

RA PD 38677

Figure 9—Recoil Band and Breech Parts

(7)  
front  
directi  
locking  
(8)  
a rect  
a guid  
is rais  
(9)  
block

## DESCRIPTION AND FUNCTIONING

RA PD 38679

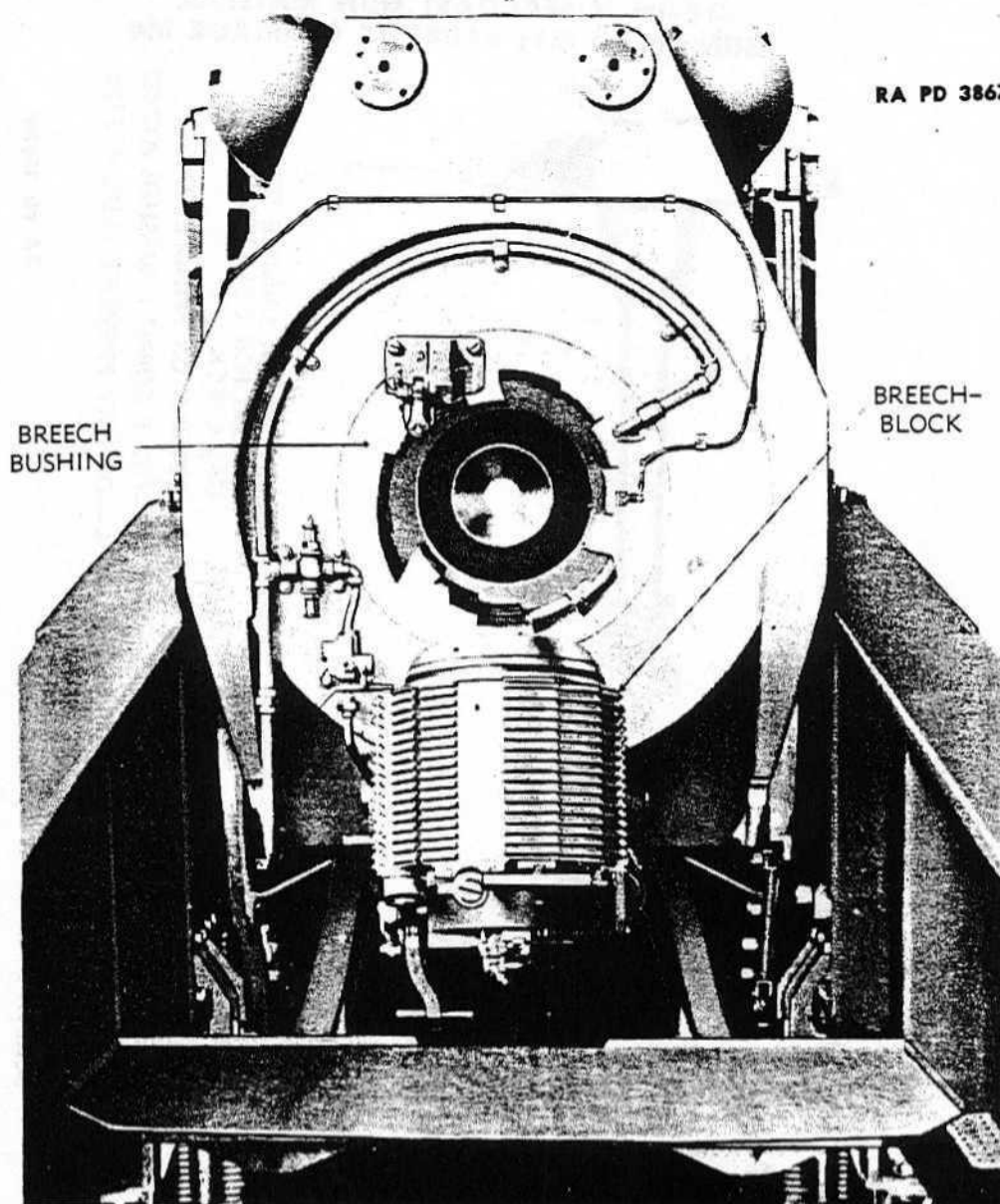

Figure 10—Breech Open

(7) CAUTION PLATE. A caution plate (T, fig. 14) is attached to the front surface of the upper rotating cam. On this plate are inscribed directions for the procedure to be followed in the use of the salvo latch locking pin (P, fig. 14).

(8) ARM GUIDE. An arm on the lower cam (fig. 15) projects through a rectangular opening in the flat surface of the block carrier and acts as a guide for the proper alinement of the moving parts when the carrier is raised or lowered.

(9) CAM ROLLER BRACKETS. A cam roller bracket (M, fig. 13), carrying the upper cam roller (N, fig. 13), and a cam roller bracket (AD, fig. 13), carrying the lower cam roller, are secured to the breechblock by means of breechblock guide clips and bolts (L, fig. 13).

TWO-  
NDARD

A217813

D

OD)

ITEM 1  
61-26-6242368  
ORM

RM

PD

16-INCH SEACOAST GUN MATERIEL  
GUN MK. II M1; BARBETTE CARRIAGE M4

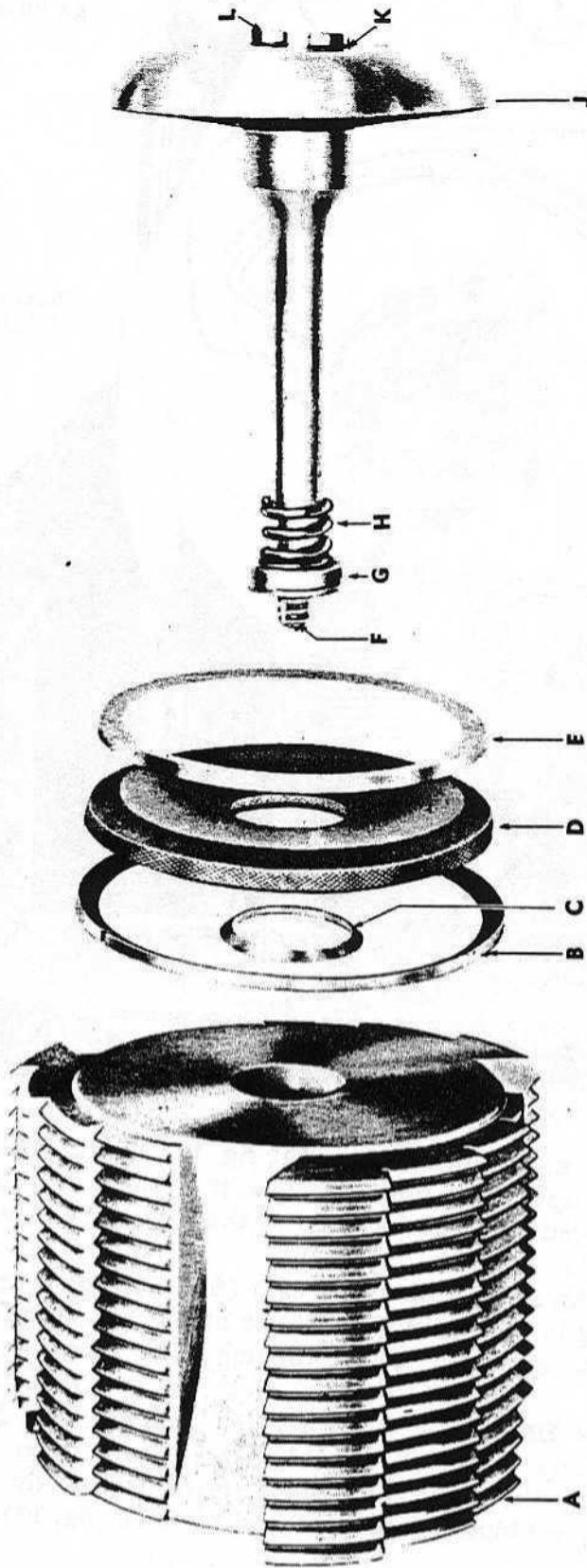

A—BREECHBLOCK 61-26-61  
ITEM 1

B—OBTURATOR SPLIT REAR RING  
61-26-63 ITEM 4

C—OBTURATOR INNER RING  
61-26-63 ITEM 5

D—OBTURATOR GAS CHECK PAD  
61-26-63 ITEM 2

E—OBTURATOR SPLIT FRONT RING  
61-26-63 ITEM 3

F—(REMOVABLE) PRIMER SEAT  
61-26-107 ITEM 1 WITH  
SOFT COPPER GASKET  
61-26-107 ITEM 2

G—OBTURATOR SPINDLE NUT  
AN110F WITH LOCKING CAP  
SCREW BCCX1EC

H—OBTURATOR SPINDLE SPRING  
AN100G FOR COMPRESSING  
GAS CHECK PAD

J—OBTURATOR SPINDLE D36510

K—(SOFT COPPER) WASHER A12427

L—DUMMY PRESSURE PLUG A12426

RA PD 38680

Figure 11—Breechblock—Gas Check Pad and Obturator Spindle—Exploded View

(1)  
rolle  
brack  
AE, 1  
b.  
block  
(1  
brac  
i  
oper

## DESCRIPTION AND FUNCTIONING

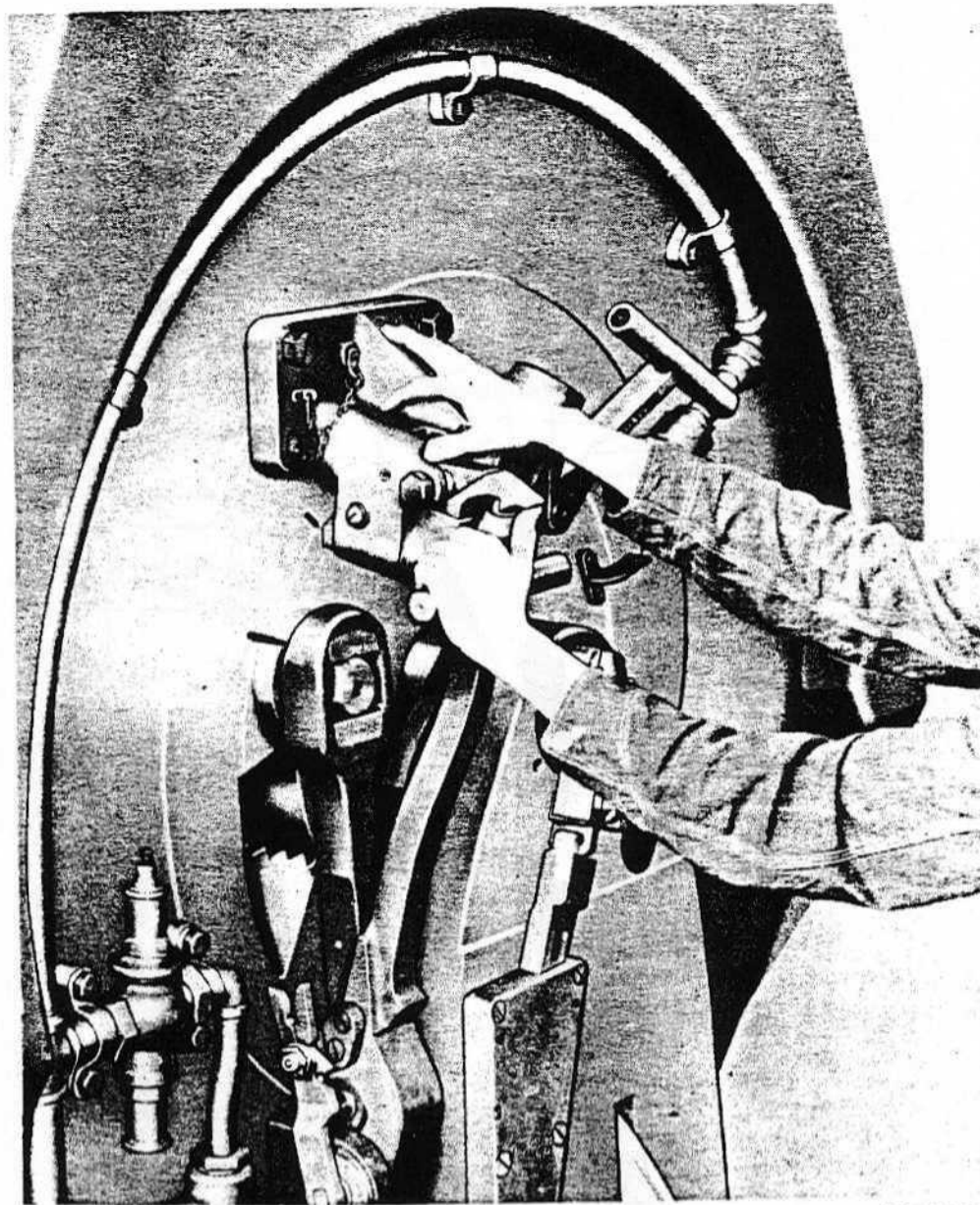

RA PD 38681

**Figure 12—Unlatching the Breech Operating Lever**

(10) **ROLLER PIVOTS.** Roller pivots (Z, fig. 13) on which the cam rollers are assembled are screwed into the upper and lower cam roller brackets and secured in place by means of set screws (AA, fig. 13, and AE, fig. 13).

**b. Breechblock Carrier.** The breechblock is supported by a breechblock carrier (figs. 16 and 19-1).

(1) The lower end of the carrier is hinged to the carrier hinge pin bracket (F, fig. 18) which is bolted to the under side of the gun. This device is provided with eccentric bushings (G, fig. 18) which must be carefully assembled by matching the locating marks to insure proper operation of the block carrier.

L—DUMMY PRESSURE PLUG A12426

RA PD 38680

G—OBTURATOR SPINDLE NUT  
ANTI-OFF WITH L  
SCREW BCCX1EC

**Figure 11—Breechblock—Gas Check Pad and Obturator Spindle—Exploded View**

U—SUBJECT FOR GAS CHECK PAD  
26-63 ITEM 2

16-INCH SEACOAST GUN MATERIEL  
GUN MK. II M1; BARBETTE CARRIAGE M4

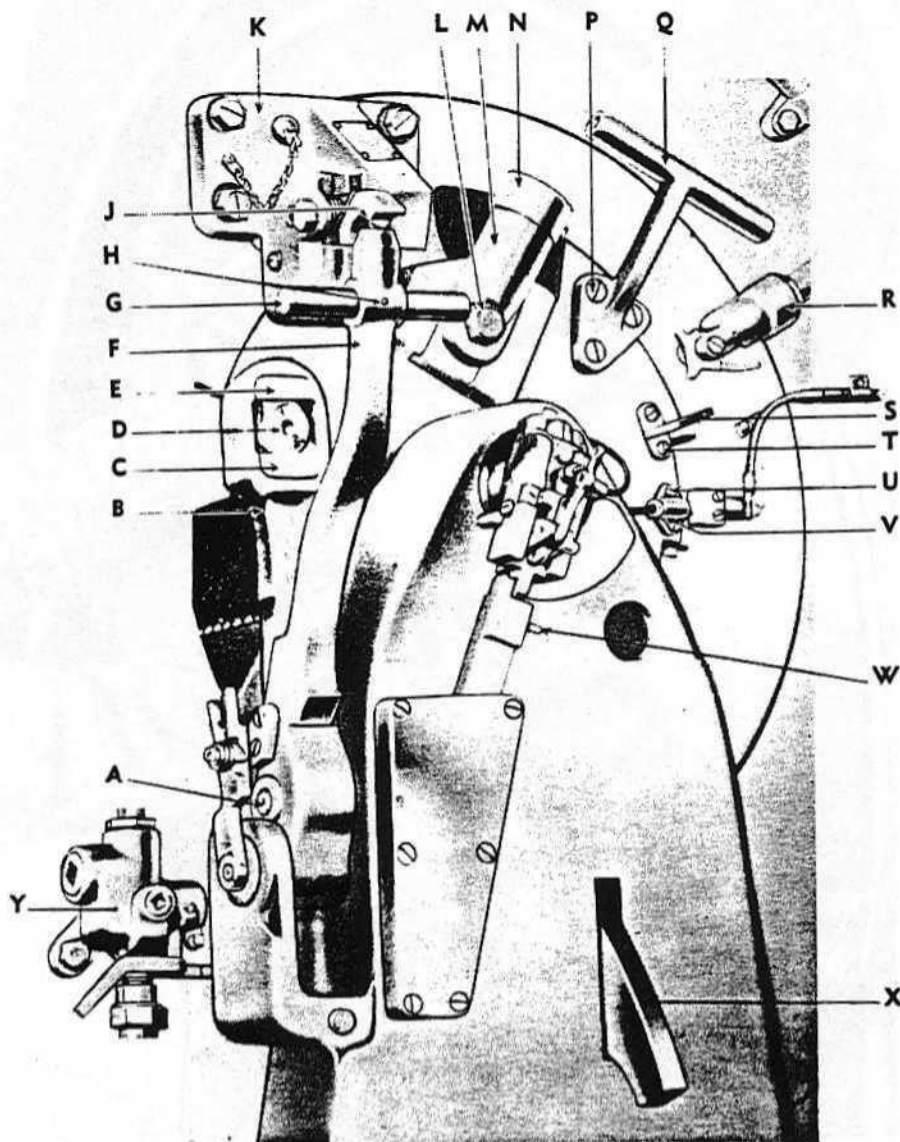

- |   |   |
|---|---|
| A—ROTATING LINK BALL PIN<br>AN102A                    | J—OPERATING LEVER CATCH<br>AN114H             |
| B—OPERATING LEVER CONNECT-<br>ING ROD 61-26-71 ITEM 1 | K—UPPER CAM 61-26-78 ITEM 1                   |
| C—BREECHBLOCK ROTATING PIN<br>(LOWER) BEARING AN101B  | L—(CAM ROLLER BRACKET) BOLT<br>BANX2EP        |
| D—BREECHBLOCK ROTATING PIN<br>AN101C                  | M—UPPER CAM ROLLER BRACKET<br>61-26-77 ITEM 1 |
| E—BREECHBLOCK ROTATING PIN<br>(UPPER) BEARING AN101A2 | N—CAM ROLLER AN111C                           |
| F—BREECH OPERATING LEVER<br>61-26-70 ITEM 1           | P—(BREECHBLOCK HANDLE)<br>SCREW A25639        |
| G—OPERATING LEVER HANDLE<br>AN102F                    | Q—BREECHBLOCK HANDLE<br>61-26-69 ITEM 3       |
| H—(OPERATING LEVER HANDLE)<br>RIVET BMCX2             | (CONTINUED ON NEXT PAGE)                      |

RA PD 38682

Figure 13—Breechblock Operating Parts

DESCRIPTION AND FUNCTIONING

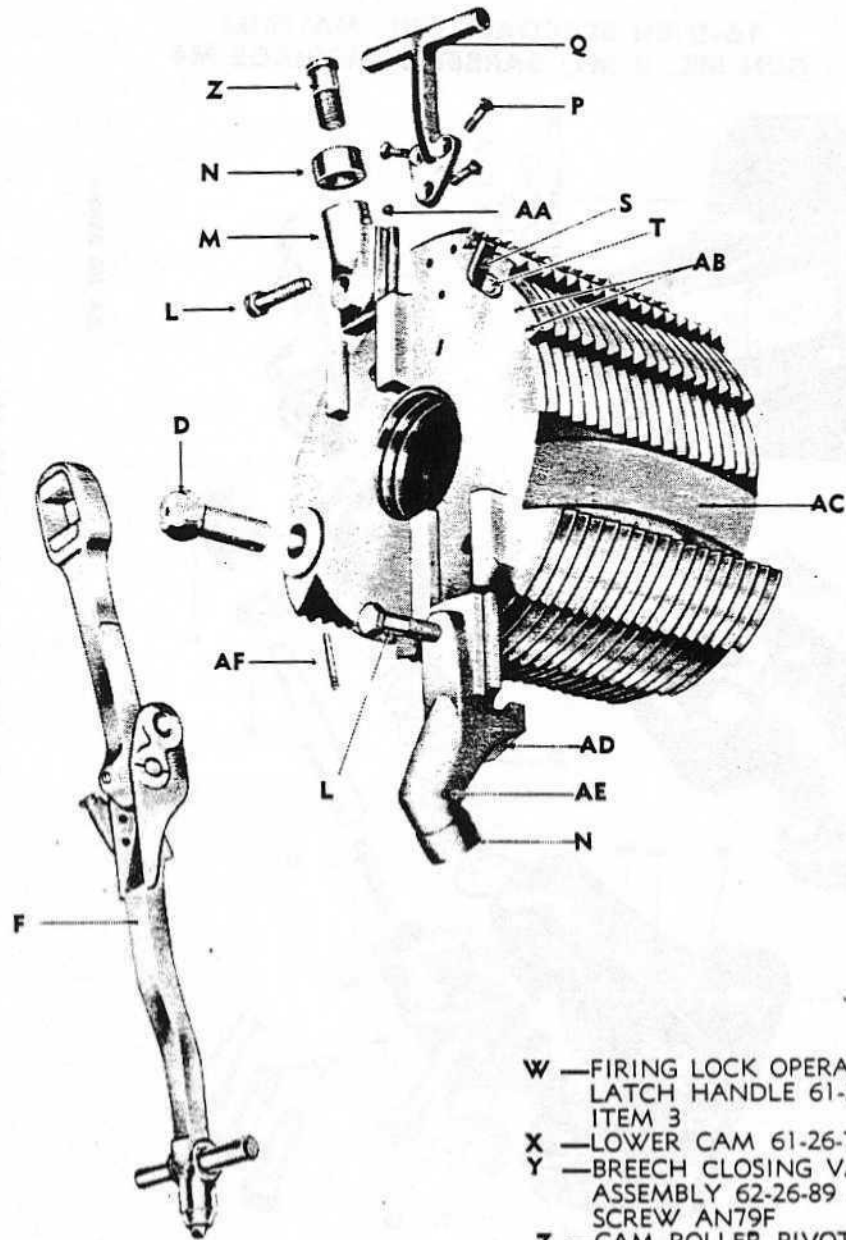

(ITEMS A TO Q LISTED ON PRECEDING PAGE)

- R—GAS EJECTOR VALVE 61-26-98
- S—GAS EJECTOR VALVE TRIP PLATE 61-26-98 ITEM 7
- T—(TRIP PLATE) SCREW 61-26-98 ITEM 8 AND LOCKING SCREW 61-26-98 ITEM 9
- U—CIRCUIT BREAKER SCREW A13EA
- V—CIRCUIT BREAKER HOUSING A13U4

- W—FIRING LOCK OPERATING BAR LATCH HANDLE 61-26-106 ITEM 3
- X—LOWER CAM 61-26-78 ITEM 2
- Y—BREECH CLOSING VALVE ASSEMBLY 62-26-89 AND SCREW AN79F
- Z—CAM ROLLER PIVOT AN111D
- AA—(ROLLER PIN) SET SCREW HEADLESS 12-Z-4-110
- AB—HOLES FOR FIRING CIRCUIT CONTACT PLUNGER
- AC—BREECHBLOCK 61-26-61 ITEM 1
- AD—LOWER CAM ROLLER BRACKET 61-26-77 ITEM 2
- AE—(ROLLER PIN) SET SCREW 12-Z-4-110
- AF—(BREECHBLOCK ROTATING PIN) LOCKING SCREW 61-26-71 ITEM 5

Figure 13-1—Breechblock—Exploded View

CATCH  
78 ITEM 1  
(CKET) BOLT  
R BRACKET  
11C  
(NDLE)  
NDLE  
PAGE)

A 8682

RA PD 38683

16-INCH SEACOAST GUN MATERIEL  
GUN MK. II M1; BARBETTE CARRIAGE M4

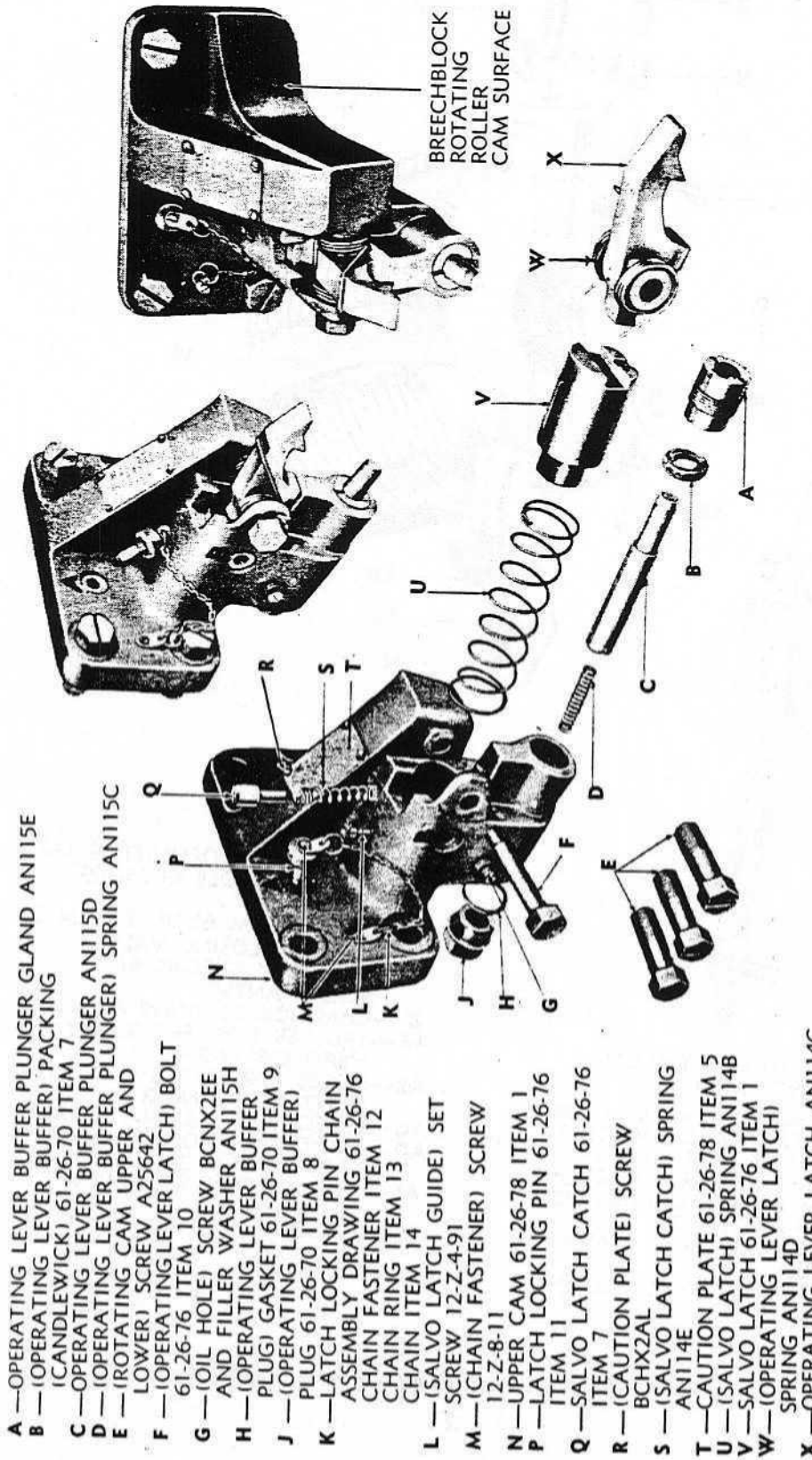

RA PD 38684

Figure 14—Salvo Latch and Upper Rotating Cam—Exploded and Assembly Views

(A) SCREW A21

(2) The threaded end of the block.

(3) However, the operating lever prevents the latch (17) is released.

(4) Operating lever carrier block breech operation (Q, fig. 19) in the carriage.

(a) The end on which the pin is attached and pinned.

(b) The end on which the pin is attached when the cam is in the open position.

- A—OPERATING LEVER BUFFER PLUNGER GLAND AN115E
- B—(OPERATING LEVER BUFFER) PACKING (CANDLEWICK) 61-26-70 ITEM 7
- C—OPERATING LEVER BUFFER PLUNGER AN115D
- D—(OPERATING LEVER BUFFER PLUNGER) SPRING AN115C
- E—(ROTATING CAM UPPER AND LOWER) SCREW A25642
- F—(OPERATING LEVER LATCH) BOLT 61-26-76 ITEM 10
- G—(OIL HOLE) SCREW BCNX2EE AND FILLER WASHER AN115H
- H—(OPERATING LEVER BUFFER PLUG) GASKET 61-26-70 ITEM 9
- J—(OPERATING LEVER BUFFER) PLUG 61-26-70 ITEM 8
- K—LATCH LOCKING PIN CHAIN ASSEMBLY DRAWING 61-26-76 CHAIN FASTENER ITEM 12 CHAIN RING ITEM 13 CHAIN ITEM 14
- L—(SALVO LATCH GUIDE) SET SCREW 12-Z-4-91
- M—(CHAIN FASTENER) SCREW 12-Z-8-11
- N—UPPER CAM 61-26-78 ITEM 1
- P—LATCH LOCKING PIN 61-26-76 ITEM 11
- Q—SALVO LATCH CATCH 61-26-76 ITEM 7
- R—(CAUTION PLATE) SCREW BCHX2AL
- S—(SALVO LATCH CATCH) SPRING AN114E
- T—CAUTION PLATE 61-26-78 ITEM 5
- U—(SALVO LATCH) SPRING AN114B
- V—SALVO LATCH 61-26-76 ITEM 1
- W—(OPERATING LEVER LATCH) SPRING AN114D
- X—OPERATING LEVER LATCH AN114C

**DESCRIPTION AND FUNCTIONING**

- A—SCREW - BCAX2BC
- B—(SPOOL BED) STEP B163153
- C—CRUTCH SPOOL A149858
- D—ANTI-FRICTION LEVER — C54966
- E—CRUTCH — C54982

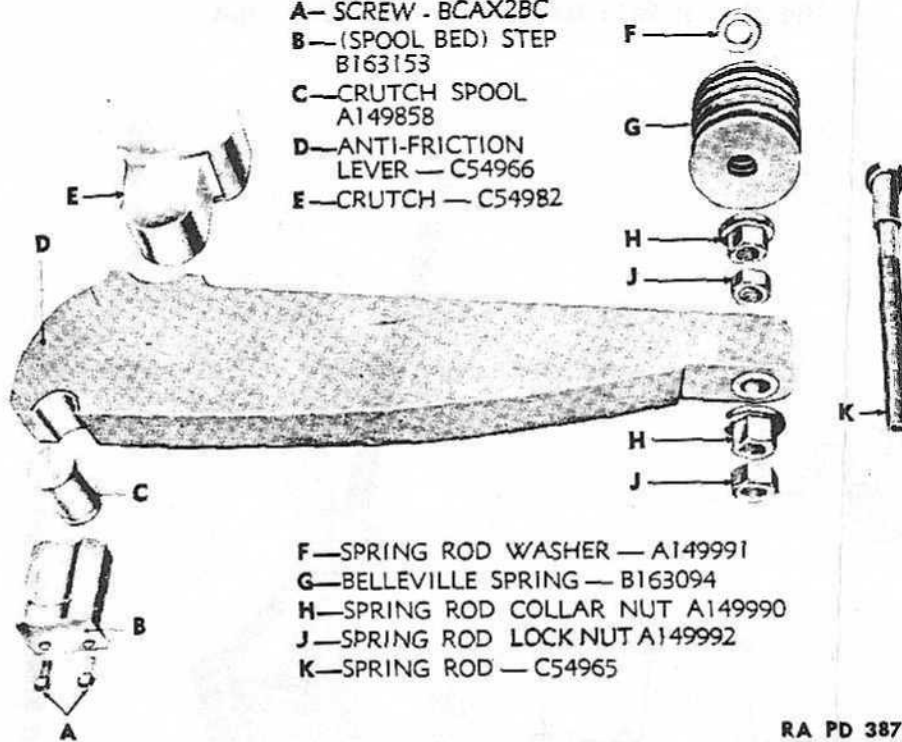

- F—SPRING ROD WASHER — A149991
- G—BELLEVILLE SPRING — B163094
- H—SPRING ROD COLLAR NUT A149990
- J—SPRING ROD LOCK NUT A149992
- K—SPRING ROD — C54965

RA PD 38762

**Figure 77—Antifriction Lever Parts**

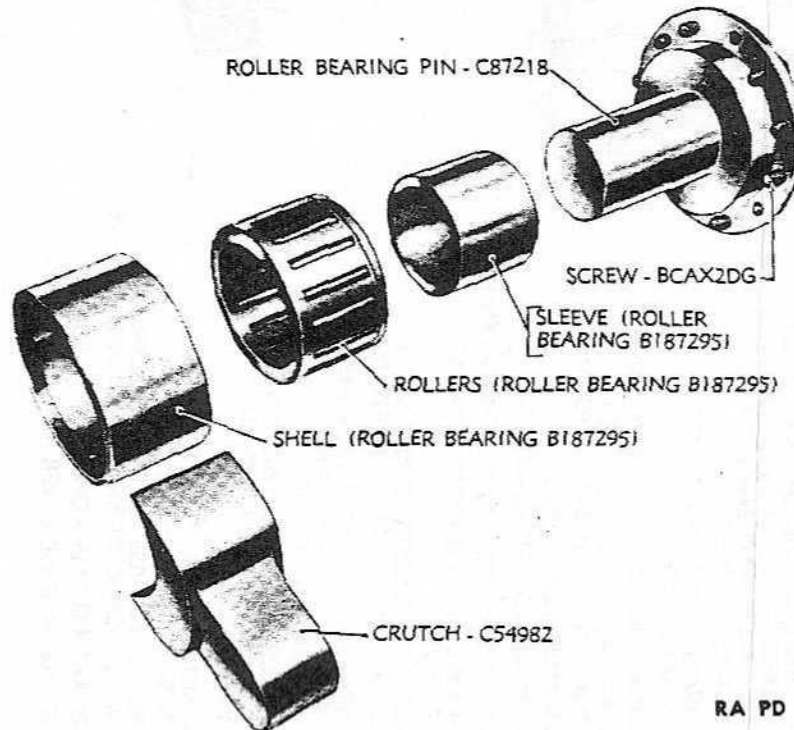

- ROLLER BEARING PIN - C87218
- SCREW - BCAX2DG
- SLEEVE (ROLLER BEARING B187295)
- ROLLERS (ROLLER BEARING B187295)
- SHELL (ROLLER BEARING B187295)
- CRUTCH - C54982

RA PD 38763

**Figure 78—Roller Bearing—Bearing Pin and Crutch (Trunnion Antifriction Device)—Exploded View**

P—ANTI-FRICTION LEVER C54966

RA PD 38761

**Figure 76—Right Trunnion Elevating Scale and Antifriction Device**

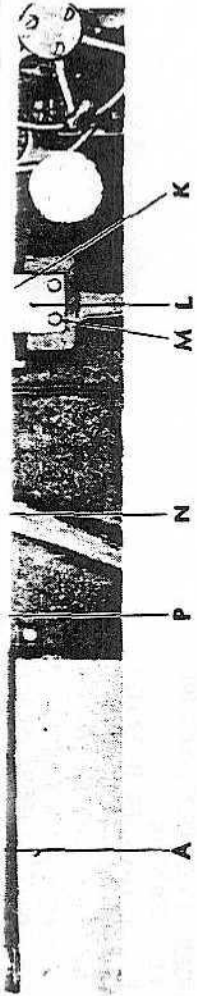



16-INCH SEACOAST GUN MATERIEL  
GUN MK. II M1; BARBETTE CARRIAGE M4

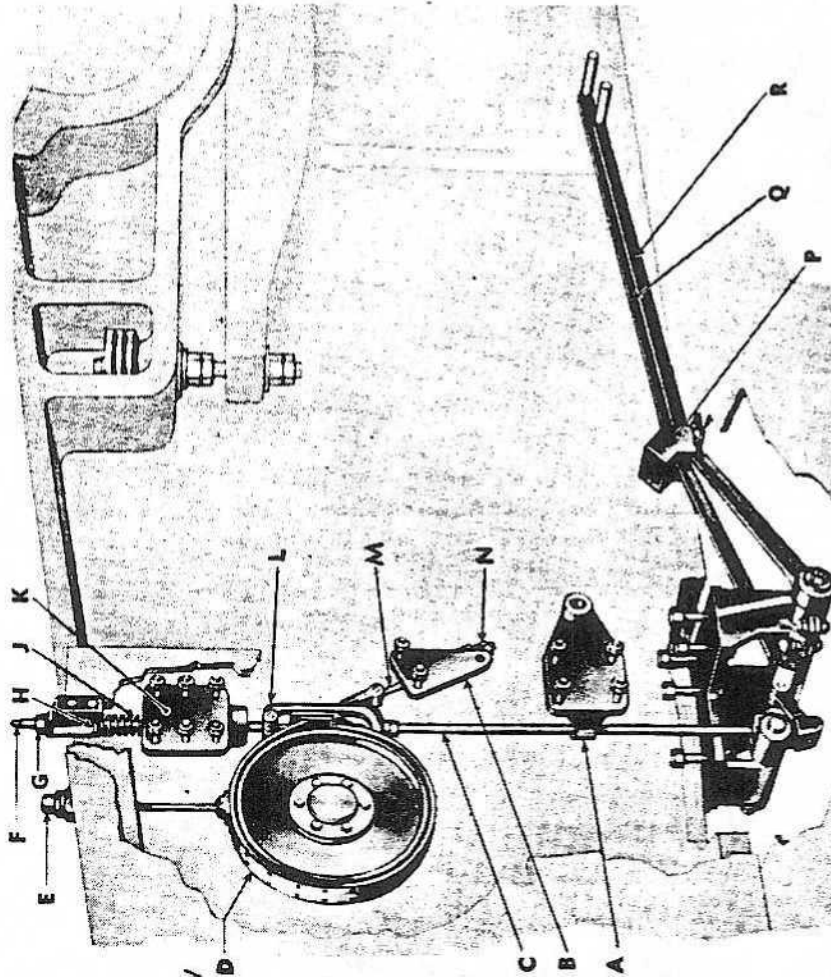

RA PD 38750

- A—BRAKE BAND ROD AND FORK LEVER BRACKET C54877—SCREW BCAX2CL AND NUT BBAX2D
- B—BRAKE BAND ROD BRACKET (LEFT) B163049—SCREW BCAX2CL AND NUT BBAX2D
- C—ADJUSTING ROD BRACKET (RIGHT) B163028A—(LEFT) B163028B WITH SCREW BCAX2CM—NUT BBAX2D AND SCREW BCAX2CE
- D—BRAKE BAND ROD A149878 AND NUT BBAX2C
- E—BRAKE BAND (ASSEMBLY) C54882
- F—(ELEVATING BRAKE BAND) SUPPORT (ASSEMBLY) B163052
- G—SPRING ROD B163027
- H—SPRING ADJUSTING NUT B163029
- I—SPRING ADJUSTING WASHER A149872
- J—BRAKE BAND GRIPPING SPRING A149871
- K—SPRING BRACKET C54883 WITH SCREW BCAX2CM AND NUT BBAX2D
- L—BRAKE ROD CONNECTION B163034 WITH PIN A149879 AND COTTER PIN BFAX2BD
- M—ADJUSTING ROD A149877 WITH PIN BFEX3ZA AND COTTER PIN BFAX1EH
- N—(ADJUSTING ROD) NUT BBAX2C AND WASHER BEBX1R
- P—BRAKE RELEASE LEVER STOP C54910 WITH SCREW BCAX2AB AND NUT BBAX2B
- Q—BRAKE RELEASE LEVER (LEFT) C54980
- R—BRAKE RELEASE LEVER (RIGHT) C54981

Figure 79—Isometric View Elevating Brake (Upper)

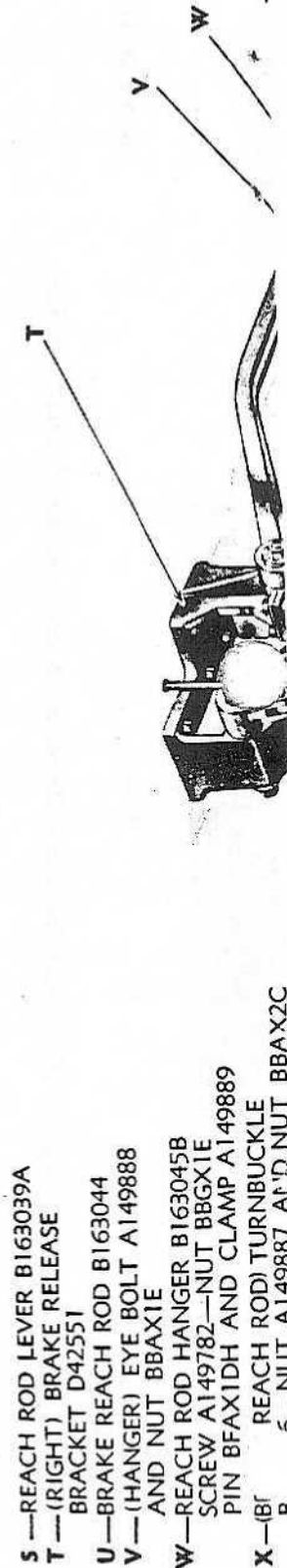

- S—REACH ROD LEVER B163039A
- T—(RIGHT) BRAKE RELEASE BRACKET D42551
- U—BRAKE REACH ROD B163044
- V—(HANGER) EYE BOLT A149888 AND NUT BBAX1E
- W—REACH ROD HANGER B163045B SCREW A149782—NUT BBGX1E PIN BFAX1DH AND CLAMP A149889
- X—(REACH ROD) TURNBUCKLE
- Y—NUT A149887 AND NUT BBAX2C

DESCRIPTION AND FUNCTIONING

RA PD 38764

Figure 79—Isometric View Elevating Brake (Upper)

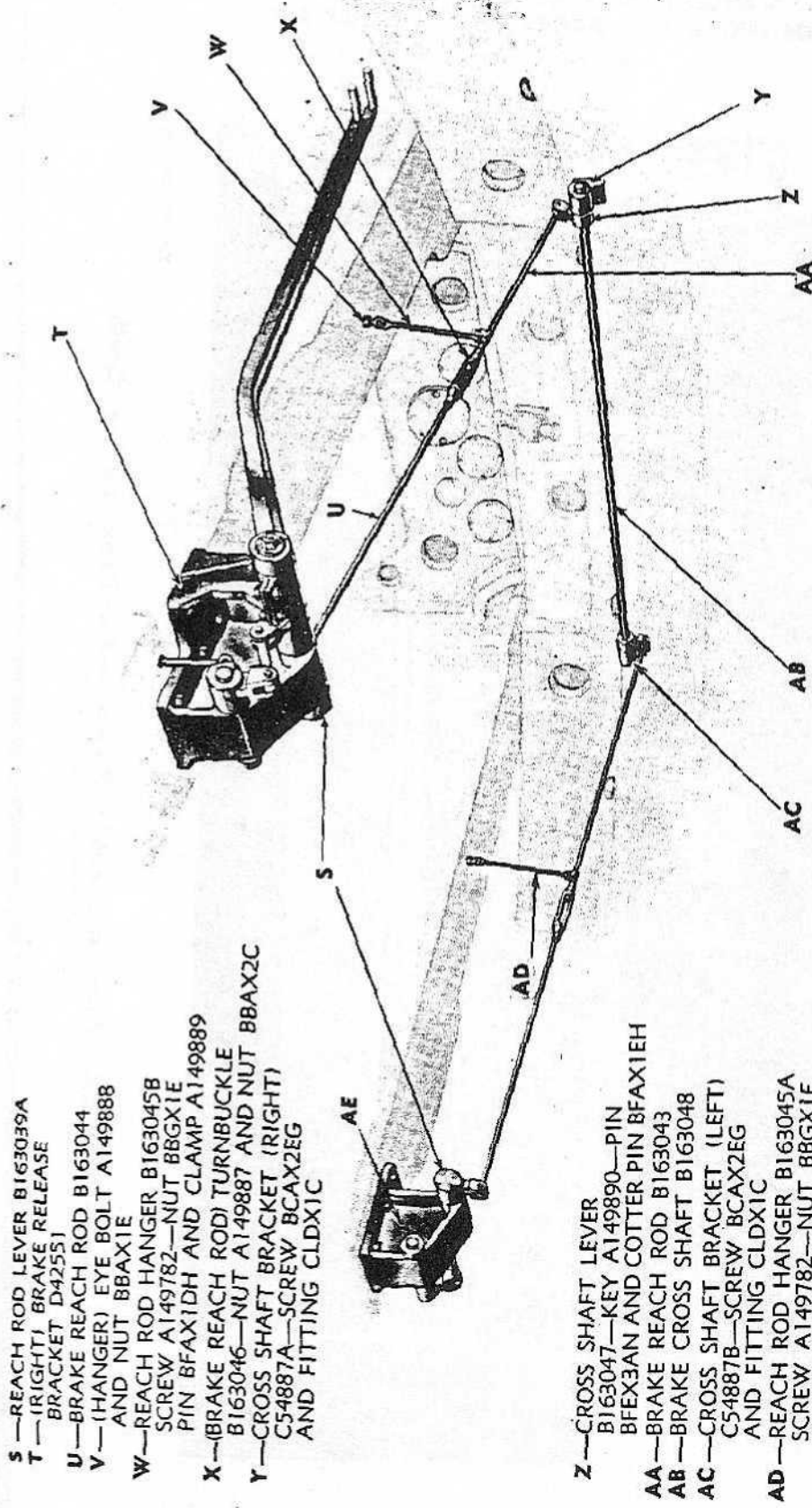

- S—REACH ROD LEVER B163039A
- T—(RIGHT) BRAKE RELEASE BRACKET D4251
- U—BRAKE REACH ROD B163044
- V—(HANGER) EYE BOLT A149888 AND NUT BBAX1E
- W—REACH ROD HANGER B163045B SCREW A149782—NUT BBGX1E PIN BFAX1DH AND CLAMP A149889
- X—(BRAKE REACH ROD) TURNBUCKLE B163046—NUT A149887 AND NUT BBAX2C
- Y—CROSS SHAFT BRACKET (RIGHT) C54887A—SCREW BCAX2EG AND FITTING CLDX1C

- Z—CROSS SHAFT LEVER B163047—KEY A149890—PIN BFEX3AN AND COTTER PIN BFAX1EH
- AA—BRAKE REACH ROD B163043
- AB—BRAKE CROSS SHAFT B163048
- AC—CROSS SHAFT BRACKET (LEFT) C54887B—SCREW BCAX2EG AND FITTING CLDX1C
- AD—REACH ROD HANGER B163045A SCREW A149782—NUT BBGX1E PIN BFAX1DH AND CLAMP A149889
- AE—(LEFT) BRAKE RELEASE BRACKET B163037

Figure 79-1—Isometric View Elevating Brake (Lower)

TM 9-471  
6

16-INCH SEACOAST GUN MATERIEL  
GUN MK. II M1; BARBETTE CARRIAGE M4

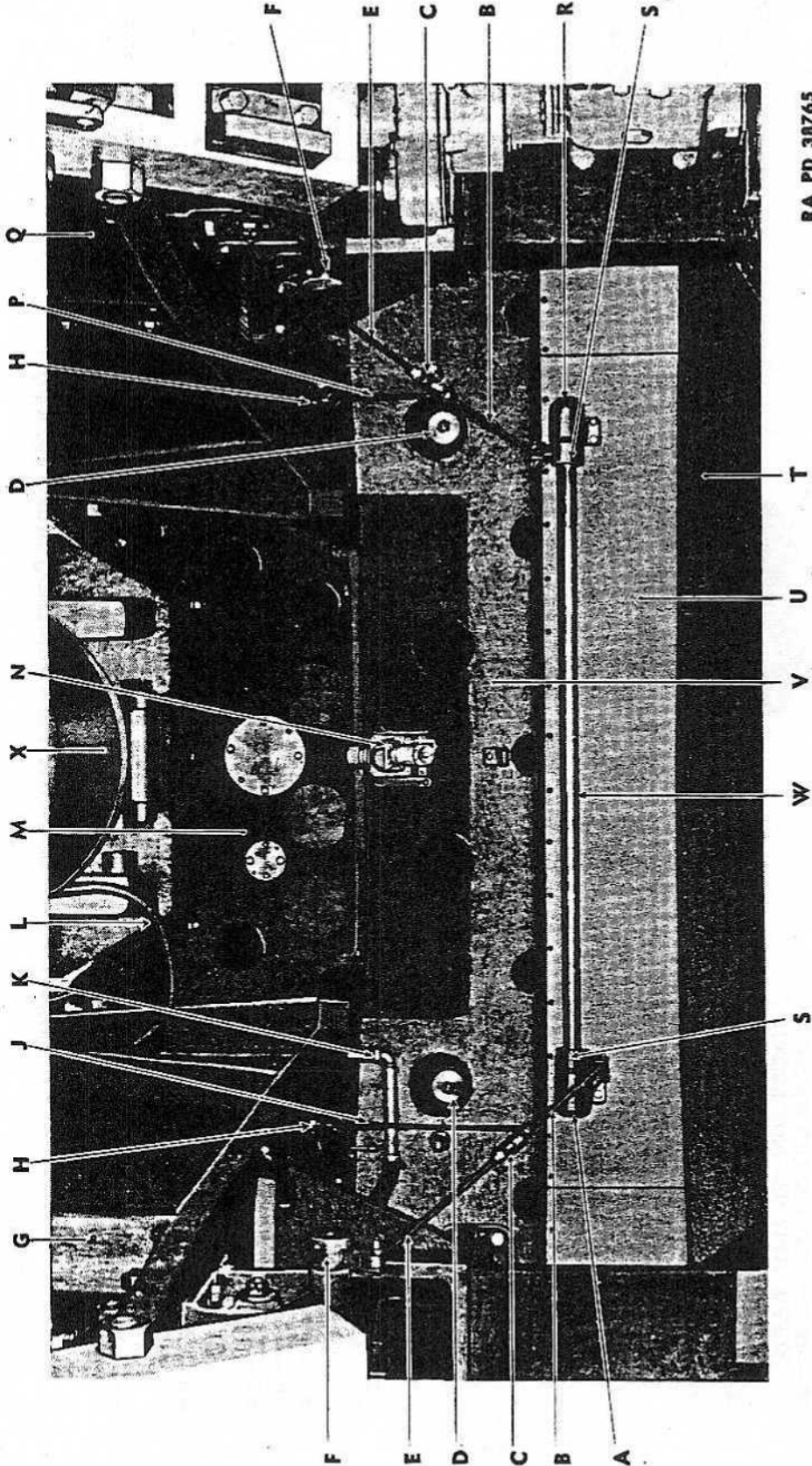

RA PD 38765

Figure 80—Inside of Carriage Looking Forward—Gun Removed from Cradle  
(LEGEND ON OPPOSITE PAGE)

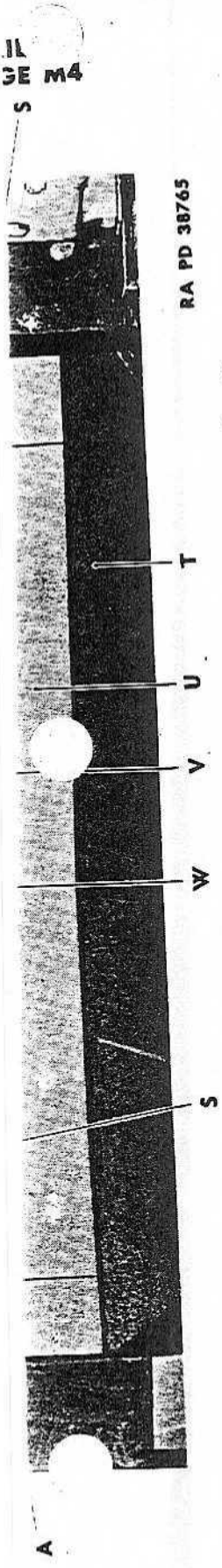

RA PD 38765

**Figure 80—Inside of Carriage Looking Forward—Gun Removed from Cradle**  
(LEGEND ON OPPOSITE PAGE)

**DESCRIPTION AND FUNCTIONING**

- A —CROSS SHAFT BRACKET (LEFT)  
C54887B—SCREW BCAX2EG AND  
FITTING CLDX1C
- B —BRAKE REACH ROD B163043
- C —BRAKE REACH ROD  
TURNBUCKLE B163046—NUT  
A149887 AND NUT BBAX2C
- D —TRAVERSING HANDWHEEL  
CLUTCH TREADLE  
COUNTERWEIGHT A149730
- E —BRAKE REACH ROD B163044
- F —REACH ROD LEVER B163039A
- G —LEFT SIDE FRAME D42550A
- H —(HANGER) EYE BOLT A149888  
AND NUT BBAXIE
- J — REACH ROD HANGER B163045A  
BOLT - A149782 - NUT BBGXIE  
PIN BFAX1DH AND CLAMP  
A149889
- K —GAS EJECTION PIPING D1202
- L —FLEXIBLE HOSE B187226
- M —FRONT TRANSOM D89
- N —POWER CABLE LOOP  
RECEPTACLE C54676
- P —REACH ROD HANGER B163045B  
—SCREW A149782—NUT BBGXIE  
—PIN BFAX1DH AND CLAMP  
A149889
- Q —RIGHT SIDE FRAME D42549A
- R —CROSS SHAFT BRACKET (RIGHT)  
C54887A—AND SCREW BCAX2EG  
AND FITTING CLDX1C
- S —CROSS SHAFT LEVER B163047  
—KEY A149890—PIN BFEX3AN  
AND COTTER PIN BFAX1EH
- T —BASE RING 4 SEGMENTS D42535
- U —RACER INNER DUST GUARD  
B162757
- V —RACER D42506A
- W —BRAKE CROSS SHAFT B163048
- X —GUN CRADLE E215

RA PD 38765A

Legend for Figure 80—Inside of Carriage Looking Forward  
(ILLUSTRATION ON OPPOSITE PAGE)

16-INCH SEACOAST GUN MATERIEL  
GUN MK. II M1; BARBETTE CARRIAGE M4

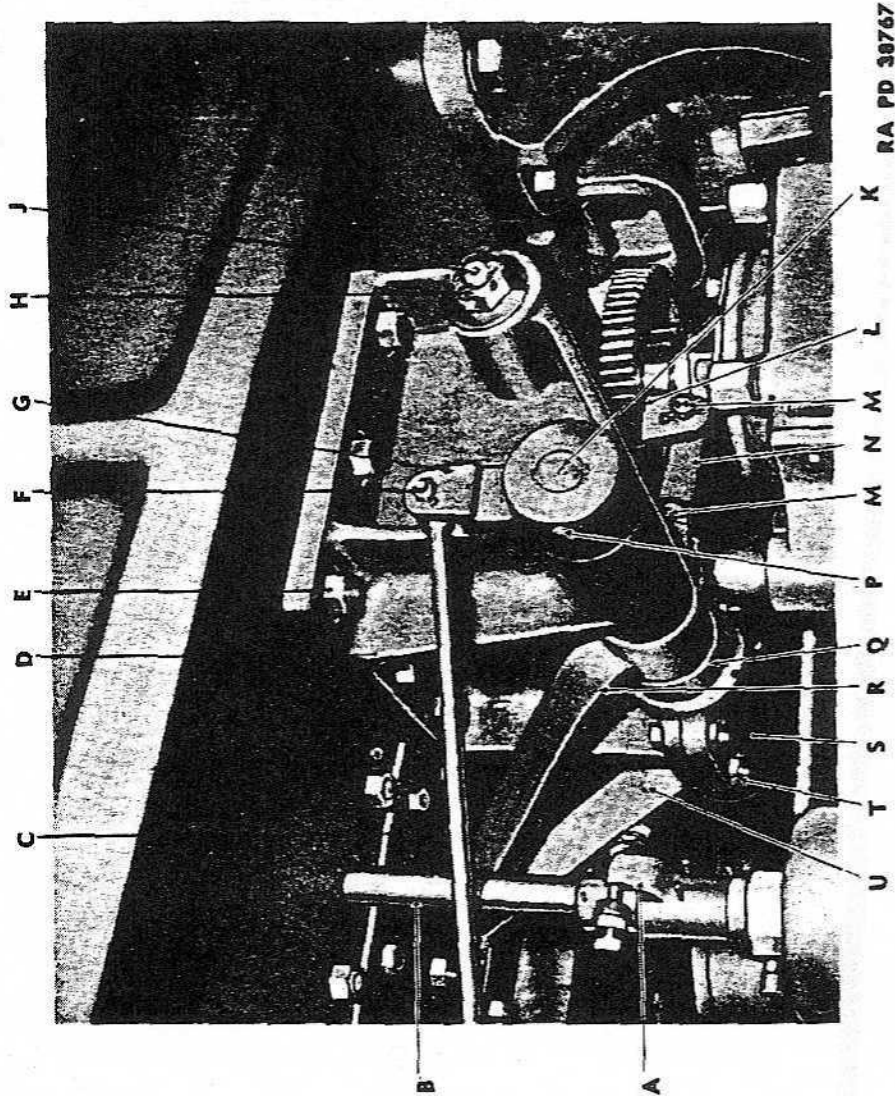

- A—ADJUSTMENT CLAMP A149842  
SLEEVE B163005—SCREW  
A149843 AND NUT A149844
- B—ELEVATING FOLLOW-UP  
CONTROL SHAFT C54871
- C—BRAKE REACH ROD B163044
- D—RIGHT BRAKE RELEASE  
BRACKET D42551
- E—SCREW BCAX2DF
- F—PIN BFEX3AN AND COTTER PIN  
BFAX1EH
- G—LEVER B163039A
- H—NUT BBGX2E—WASHER  
A149884A AND COTTER PIN  
BFAX2AB
- J—BELL CRANK SHAFT B163041
- K—BRAKE RELEASE LEVER SHAFT  
B163035
- L—BELL CRANK B163038A
- M—PIN BFEX3AN AND COTTER  
PIN BFAX1EH
- N—TOGGLE LEVER LINK A149882
- P—TAPER PIN BFDX5BM
- Q—TOGGLE LEVER B163036
- R—LEFT BRAKE RELEASE  
LEVER C54980
- S—BRACKET CAP B163042
- T—SCREW BCAX2AF AND  
NUT BBAX2B
- U—RIGHT BRAKE RELEASE  
LEVER C54981

Figure 81—Right Brake Release Bracket

C  
D  
E  
F  
G

# DESCRIPTION AND FUNCTIONING

6

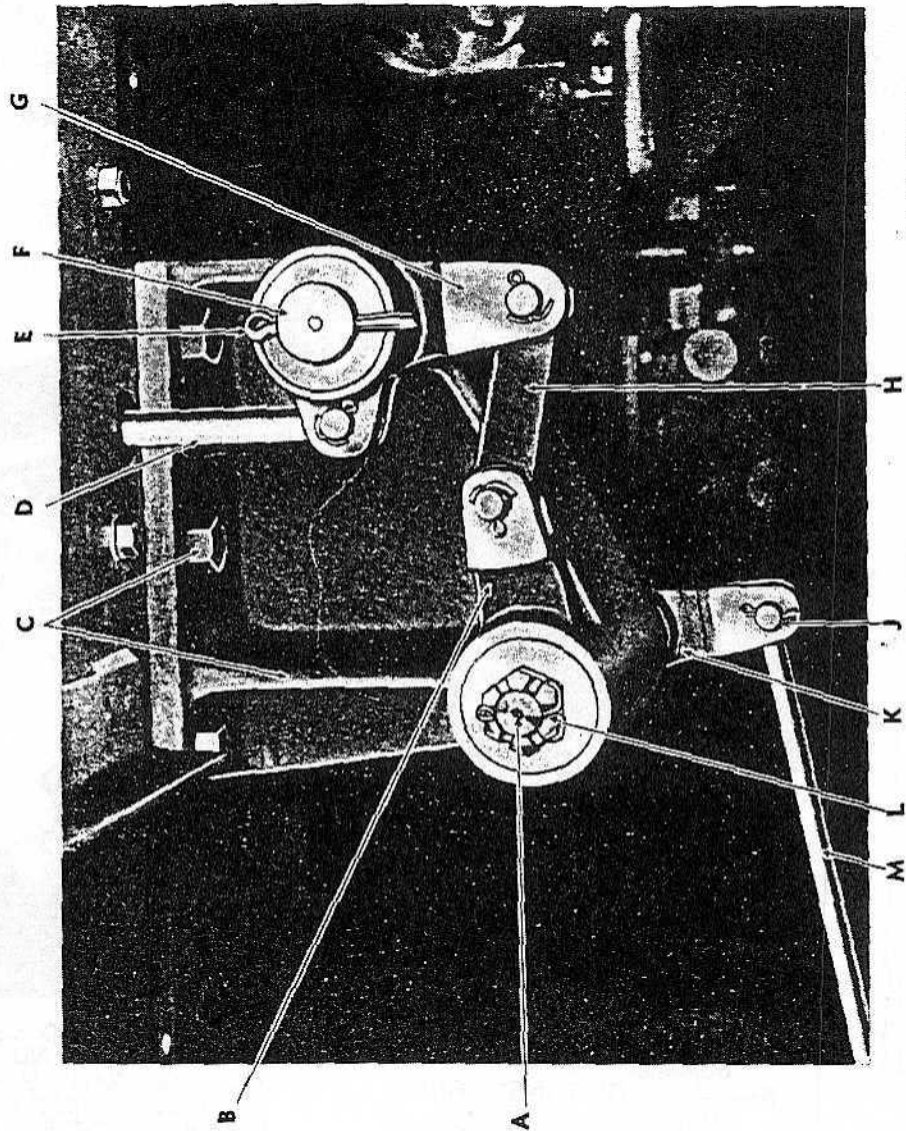

RA PD 38768

- A—REACH ROD LEVER SHAFT  
B163040
- B—TOGGLE LEVER B163039B
- C—LEFT BRAKE RELEASE BRACKET  
B163037 AND SCREW BCAX2DF
- D—(LOWER) BRAKE BAND ROD  
A149878
- E—COTTER PIN BFAX2EF AND  
WASHER A149889B
- F—BELL CRANK SHAFT B163041
- G—BELL CRANK B163038B
- H—TOGGLE LEVER LINK  
A149882
- J—PIN BFEX3AN AND  
COTTER PIN BFAX1EH
- K—REACH ROD LEVER B163039A  
AND PIN BFDX5BM
- L—NUT BBGX2E—COTTER PIN  
BFAX2AB AND WASHER  
A149884A
- M—BRAKE REACH ROD B163044

Figure 82—Left Brake Release Bracket

**16-INCH SEACOAST GUN MATERIEL  
GUN MK. II M1; BARBETTE CARRIAGE M4**

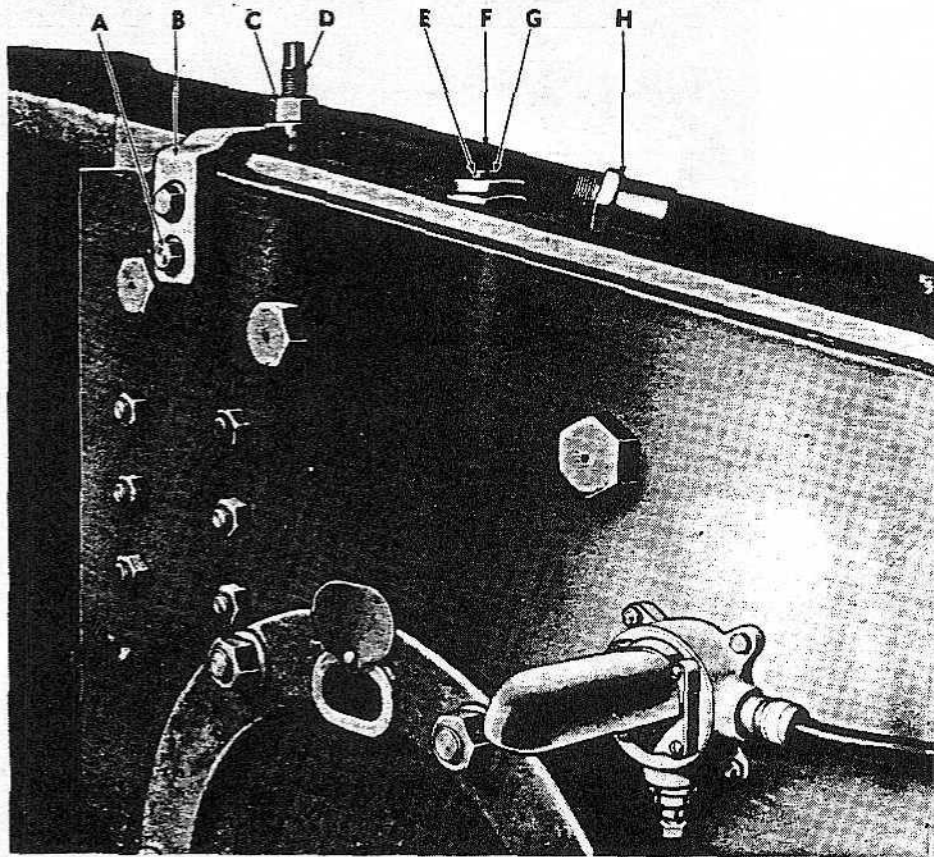

- |  |  |
|--|--|
| A—(SPRING INDICATOR) SCREW<br>BCAX2BD              | E—(BRAKE BAND SUPPORT<br>ADJUSTING) NUT BBGX1E |
| B—(BRAKE GRIPPING) SPRING<br>INDICATOR A149870     | F—BRAKE BAND SUPPORT ROD<br>(LONG) B163032     |
| C—(BRAKE GRIPPING) SPRING<br>ADJUSTING NUT B163029 | G—SPLIT COTTER PIN (1/8 x 1/4)<br>BFAX1DH      |
| D—(BRAKE GRIPPING) SPRING ROD<br>B163027           | H—(BRAKE BAND SUPPORT)<br>RETAINER CAP A149874 |

RA PD 38769A

**Figure 83—Elevating Brake Band Spring Support and  
Gripping Spring Adjusters**

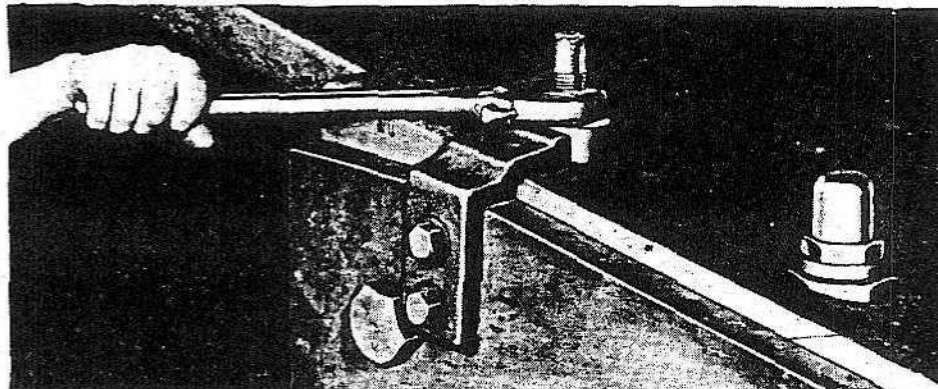

RA PD 38769

**Figure 83-1—Adjusting Tension of Brake Gripping Spring**

DESCRIPTION AND FUNCTIONING

OBSERVING CLEARANCE  
WHILE ADJUSTING  
BRAKE BAND  
SPRING SUPPORT

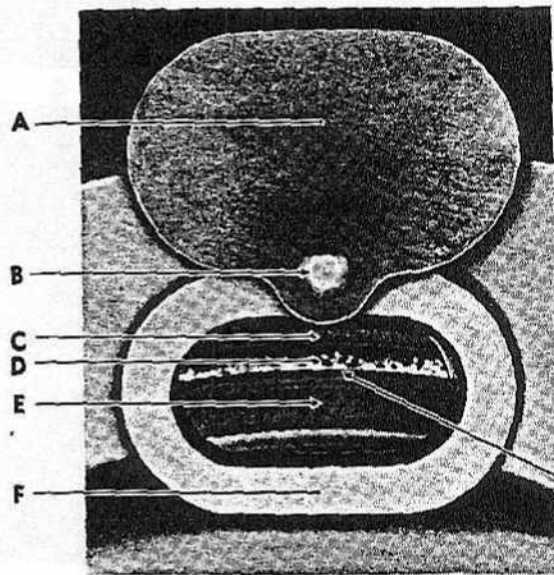
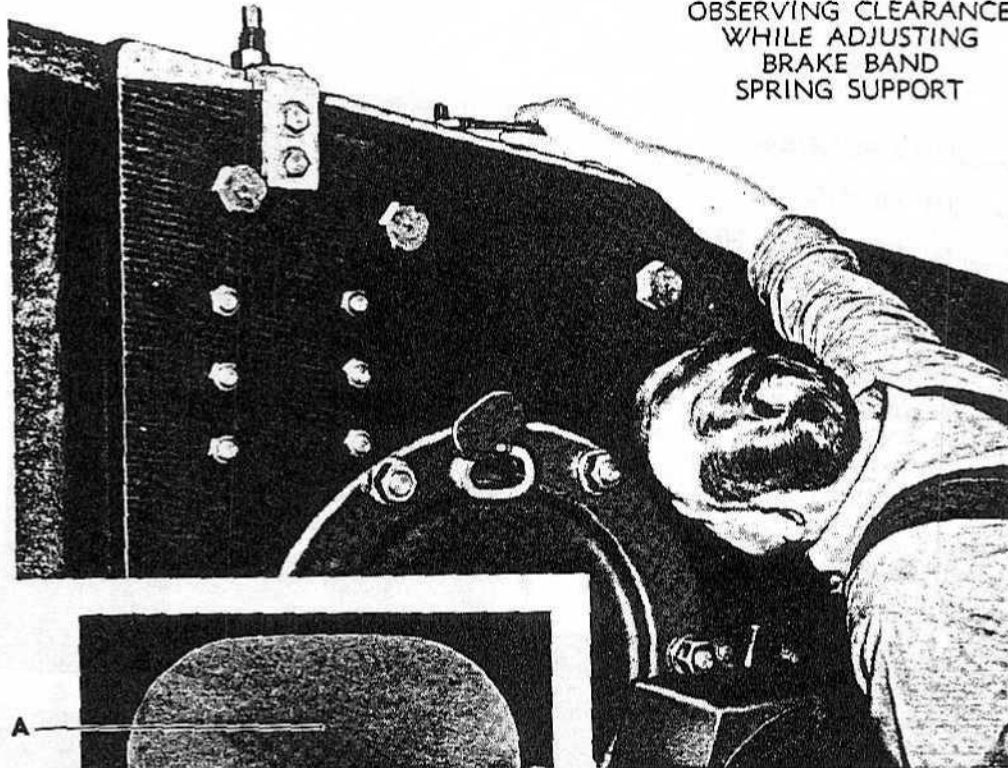

- A—BRAKE BAND PEEP HOLE COVER A149803
  - B—RIVET BMCX1
  - C—BRAKE BAND C54880
  - D—BRAKE BAND LINING C54881
  - E—BRAKE DRUM B162991
  - F—(LEFT SIDE) DRUM SHAFT BEARING C54861 (RIGHT SIDE) GEAR CASE D42539
- CLEARANCE OF 1/32 INCH WHEN BRAKE IS "OFF"

RA PD 38770

Figure 84—Elevating Brake Band Clearance (Brake Levers Up)

PIE  
ROD  
x 1 1/4  
(T)  
4  
D 38769A



RA PD 38769  
Spring



TM 9-471  
6

**16-INCH SEACOAST GUN MATERIEL  
GUN MK. II M1; BARBETTE CARRIAGE M4**

- A—SCREW BCAX2CM
- B—NUT BBAX2D
- C—ADJUSTING ROD BRACKET  
(RIGHT) B163028A  
(LEFT) B163028B
- D—WASHER BEBX1R
- E—(ADJUSTING ROD) NUT  
BBAX2C
- F—ADJUSTING ROD  
A149877
- G—SCREW BCAX2CE

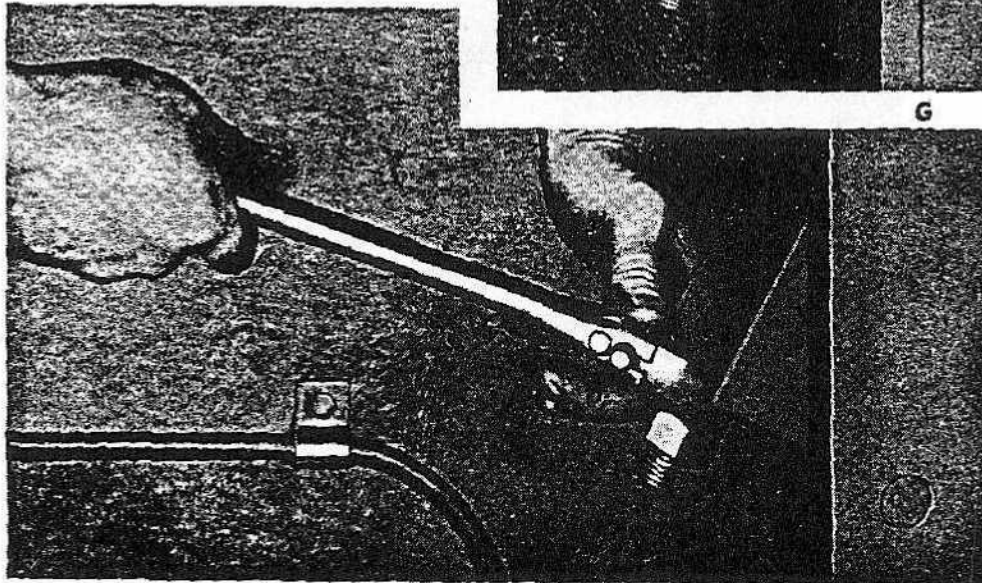
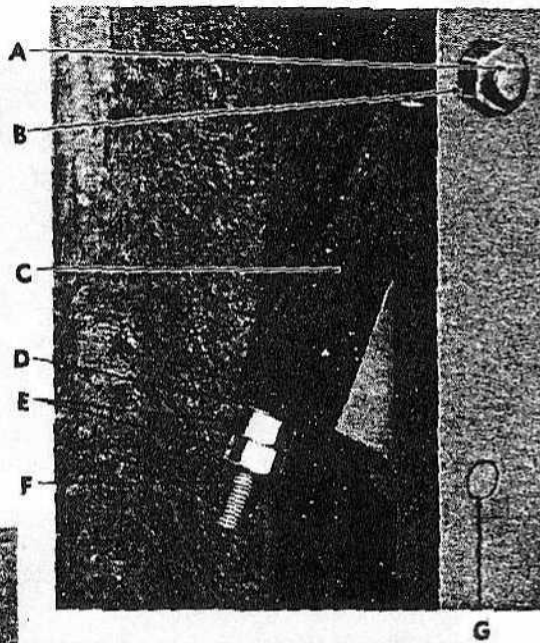

RA PD 38771

**Figure 85—Elevating Brake Wear Adjustment**

### DESCRIPTION AND FUNCTIONING

- A — (LEFT) ELEVATING GEAR PLATE D42606
- B — (LEFT) ELEVATING BRAKE DRUM SHAFT BEARING C54861
- C — (ELEVATING BRAKE BAND) PEEP HOLE COVER A149803
- D — (ELEVATING BRAKE DRUM SHAFT) ROLLER BEARING RETAINER A149806
- E — (LEFT) ELEVATING INTERMEDIATE PINION SHAFT C54856
- F — (LEFT) ELEVATING PINION SHAFT GEAR C54860
- G — ELEVATING PINION SHAFT C54855
- H — INNER PLATFORM DOOR A149916
- J — (ELEVATING BRAKE BAND ADJUSTING ROD) NUT BBAX2C
- K — ELEVATING BRAKE BAND ADJUSTING ROD BRACKET B163028B

RA PD 38772

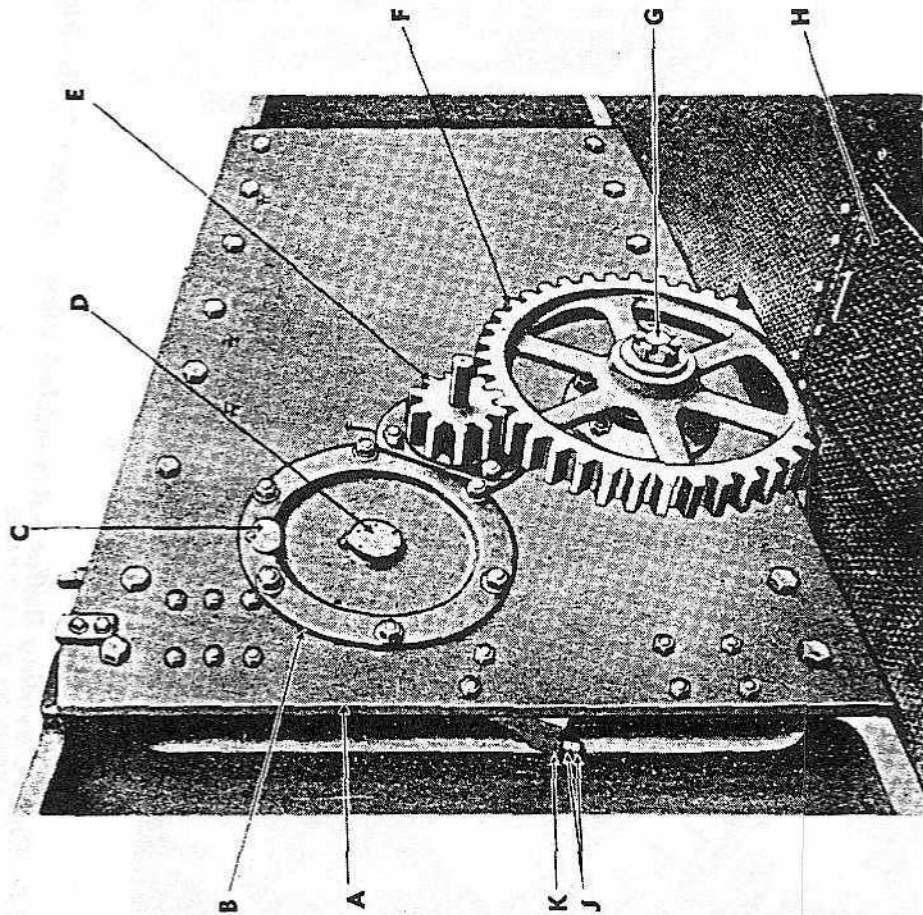
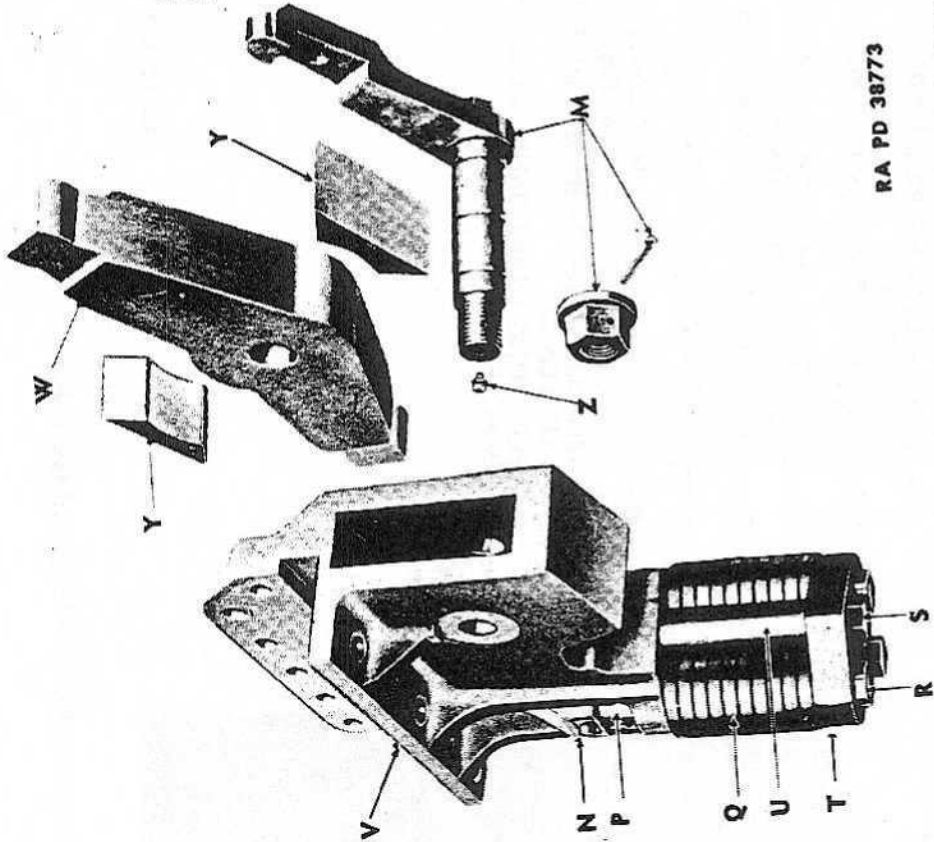

Figure 86—Left Elevating Pinion Gear and Gear Plates

16-INCH SEACOAST GUN MATERIEL  
GUN MK. II M1; BARBETTE CARRIAGE M4



RA PD 38773

Figure 87-1—Right Elevating Buffer—Partially Exploded View  
(LEGEND ON OPPOSITE PAGE)

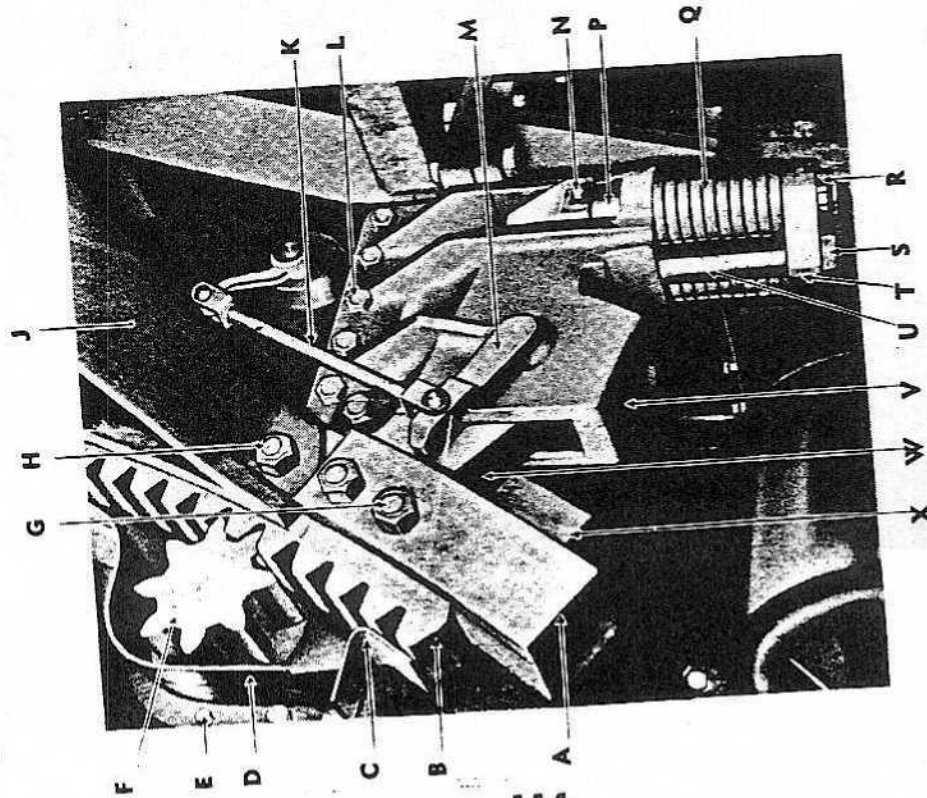

Figure 87—Right Elevating Buffer—Assembled View  
(LEGEND ON OPPOSITE PAGE)

DESCRIPTION AND FUNCTIONING

TM 9-471  
6

- A —(RIGHT DEPRESSION STOP C87029A
- B —RIGHT ELEVATING RACK D42304A(CARR. 19 TO 28)
- C —RIGHT ELEVATING RACK GUARD B126345A
- D —RIGHT ELEVATING RACK AND PINION GUARD C52770A
- E —(ELEVATING RACK AND PINION GUARD) SCREW BCAX2BB
- F —ELEVATING PINION SHAFT C54855
- G —(DEPRESSION STOP) BOLT B162405 WITH WASHER A217642 AND NUT BBAX3D
- H —(ELEVATING RACK BRACKET) BOLT B162404 WITH NUT BBAX3D
- J —RIGHT ELEVATING RACK BRACKET D42365A
- K —ELEVATING FOLLOW-UP CONTROL (ASSEMBLY) D42543
- L —(BUFFER BRACKET) BOLT B161954
- M —FOLLOW-UP CONTROL CAM LEVER B161957 WITH NUT A148855 (COTTER PIN HOLE OFF CENTER TO AVOID OIL HOLE) AND COTTER PIN BFAX2EN
- N —BUFFER SLIDE B161953 WITH PLATE WASHER A148882—SET SCREW A148812
- P —BUFFER STUD B161956
- Q —BUFFER BELLEVILLE SPRING A149859
- R —(BUFFER STUD) NUT B161952 WITH SET SCREW BCTX1DF
- S —(BUFFER PLATE) BOLT B161955 WITH PLATE WASHER A148884
- T —BUFFER PLATE B161951
- U —BUFFER SPACER A148849
- V —RIGHT BUFFER BRACKET D42143B
- W —BUFFER LEVER C54450
- X —DEPRESSION CAM B161968 WITH SCREW BCBX4CG AND LOCKING WIRE BFWX1B
- Y —GUIDE BLOCK C54449
- Z —OIL FITTING CLDX1A

RA PD 38773A

Legend for Figures 87 and 87-1—Right Elevating Buffer  
(ILLUSTRATIONS ON OPPOSITE PAGE)

TM 9-471  
6

16-INCH SEACOAST GUN MATERIEL  
GUN MK. II M1; BARBETTE CARRIAGE M4

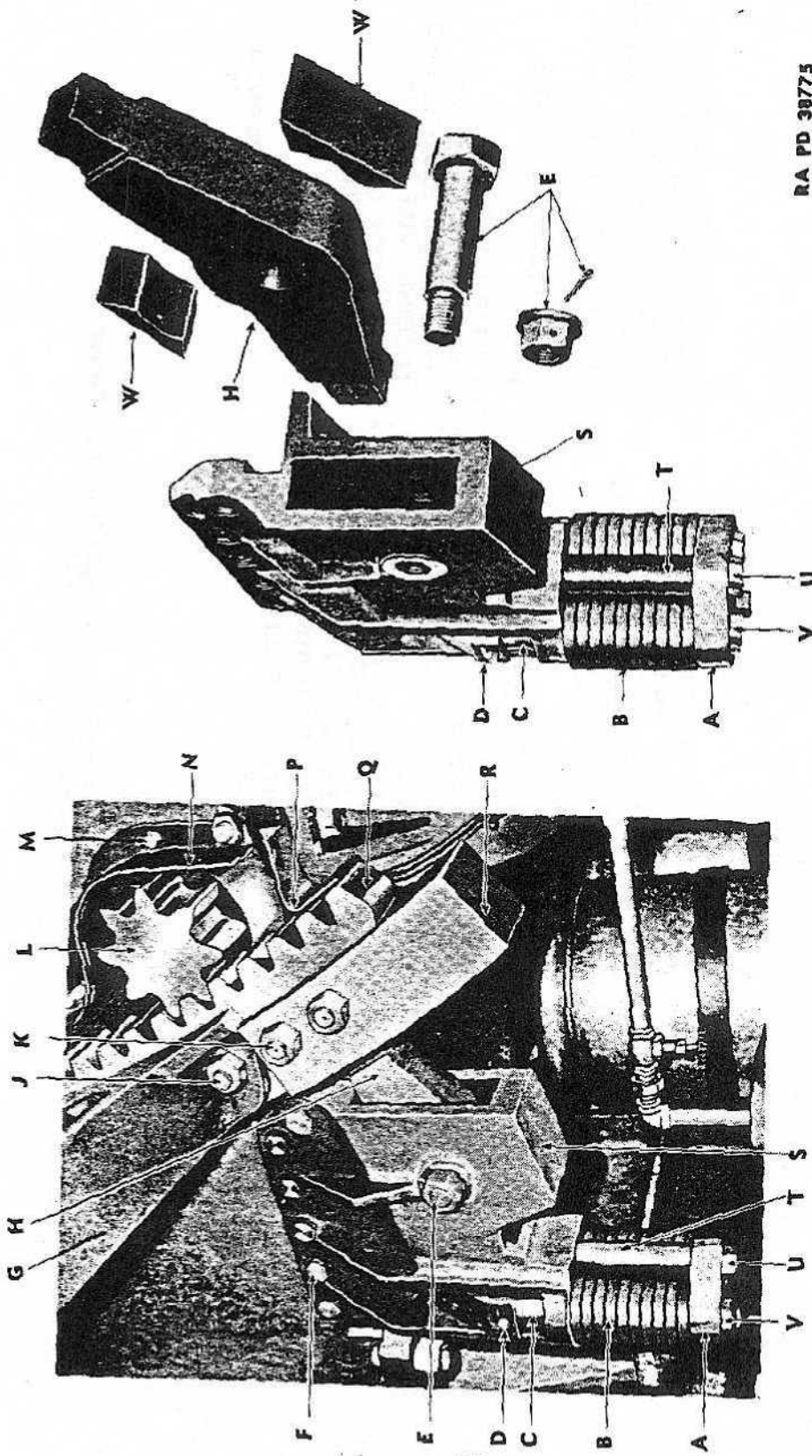

RA PD 38775

Figure 88-1—Left Elevating Buffer—Partially Exploded View  
(LEGEND ON OPPOSITE PAGE)

Figure 88—Left Elevating Buffer—Assembled View  
(LEGEND ON OPPOSITE PAGE)

**DESCRIPTION AND FUNCTIONING**

- A—BUFFER PLATE B161951
- B—BUFFER BELLEVILLE SPRING  
A149859
- C—BUFFER STUD B161956
- D—BUFFER SLIDE B161953 WITH  
PLATE WASHER A148882 AND  
SET SCREW A148812
- E—(LEFT BUFFER LEVER) BOLT  
B161950 WITH NUT A148855 —  
COTTER PIN BFAX2EN
- F—(BUFFER BRACKET) BOLT B161954
- G—LEFT ELEVATING RACK BRACKET  
D42365B
- H—BUFFER LEVER C54450
- J—(RACK BRACKET) BOLT B162404  
WITH NUT BBAX3D
- K—(DEPRESSION STOP) BOLT  
B162405 WITH WASHER A217642  
AND NUT BBAX3D
- L—ELEVATING PINION SHAFT  
C54855
- M—(ELEVATING RACK AND  
PINION GUARD) SCREW BCAX2BB
- N—LEFT ELEVATING RACK AND  
PINION GUARD C52770B
- P—LEFT ELEVATING RACK GUARD  
B126345B
- Q—LEFT ELEVATING RACK
- R—LEFT BUFFER DEPRESSION STOP  
C87029B
- S—LEFT BUFFER BRACKET D42143A
- T—BUFFER SPACER A148849
- U—(BUFFER PLATE) BOLT B161955  
AND PLATE WASHER A148884
- V—(BUFFER STUD) NUT B161952  
WITH SET SCREW BCTX1DF
- W—GUIDE BLOCK C54449

RA PD 38775A

**Legend for Figures 88 and 88-1—Left Elevating Buffer**  
(ILLUSTRATIONS ON OPPOSITE PAGE)

117

16-INCH SEACOAST GUN MATERIEL  
GUN MK. II M1; BARBETTE CARRIAGE M4

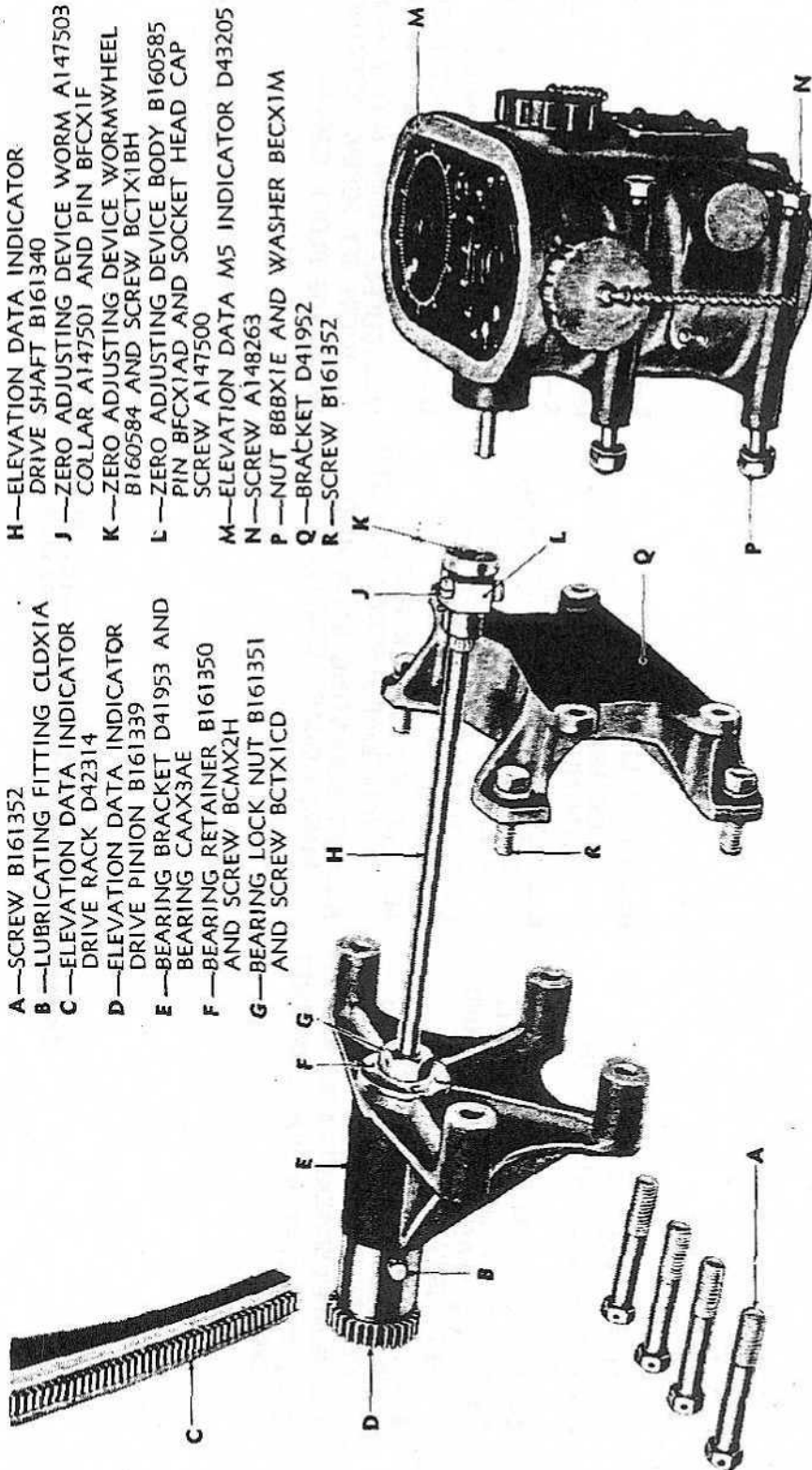

- A—SCREW B161352
- B—LUBRICATING FITTING CLDX1A
- C—ELEVATION DATA INDICATOR DRIVE RACK D42314
- D—ELEVATION DATA INDICATOR DRIVE PINION B161339
- E—BEARING BRACKET D41953 AND BEARING CAAX3AE
- F—BEARING RETAINER B161350 AND SCREW BCMX2H
- G—BEARING LOCK NUT B161351 AND SCREW BCTX1CD

- H—ELEVATION DATA INDICATOR DRIVE SHAFT B161340
- J—ZERO ADJUSTING DEVICE WORM A147503 COLLAR A14750J AND PIN BFCX1F
- K—ZERO ADJUSTING DEVICE WORMWHEEL B160584 AND SCREW BCTX1BH
- L—ZERO ADJUSTING DEVICE BODY B160585 PIN BFCX1AD AND SOCKET HEAD CAP SCREW A147500
- M—ELEVATION DATA M5 INDICATOR D43205
- N—SCREW A148263
- P—NUT BBBX1E AND WASHER BECX1M
- Q—BRACKET D41952
- R—SCREW B161352

RA PD 38777

Figure 89—Elevation Data Indicator Drive Mechanism

DESCRIPTION AND FUNCTIONING

- A—JUNCTION BOX B162525
- B—TRAVERSING CRANKSHAFT GEAR GUARD (RIGHT) D42581
- C—CRANKSHAFT (ASSEMBLY) B163053
- D—TRAVERSING SLOW-MOTION HANDWHEEL ASSEMBLY (RIGHT) D42564
- E—TELESCOPE MOUNT 15-2A43 DRAWING 2
- F—SIGHTING REST ASSEMBLY C54827
- G—HAND LAMP PLUG RECEPTACLE (CONDULET B127998 HOUSING B128000)
- H—FIRING CIRCUIT PLUG B160200
- J—SWITCH LAMP RECEPTACLE BOX B162529 AND LAMP E13AN
- K—AZIMUTH DATA INDICATOR D43208
- L—TRAVERSING SLOW-MOTION HANDWHEEL ASSEMBLY (LEFT) D42524
- M—TRAVERSING CRANKSHAFT GEAR GUARD (LEFT) D42582
- N—TRAVERSING MECHANISM COVER D42562
- P—TRAVERSING GEAR COVER D42554
- Q—TRAVERSING SPEED CONTROL GEAR GUARD C54974
- R—AZIMUTH DATA INDICATOR DRIVE ASSEMBLY D42647
- S—TRAVERSING LIMIT SWITCH C87140

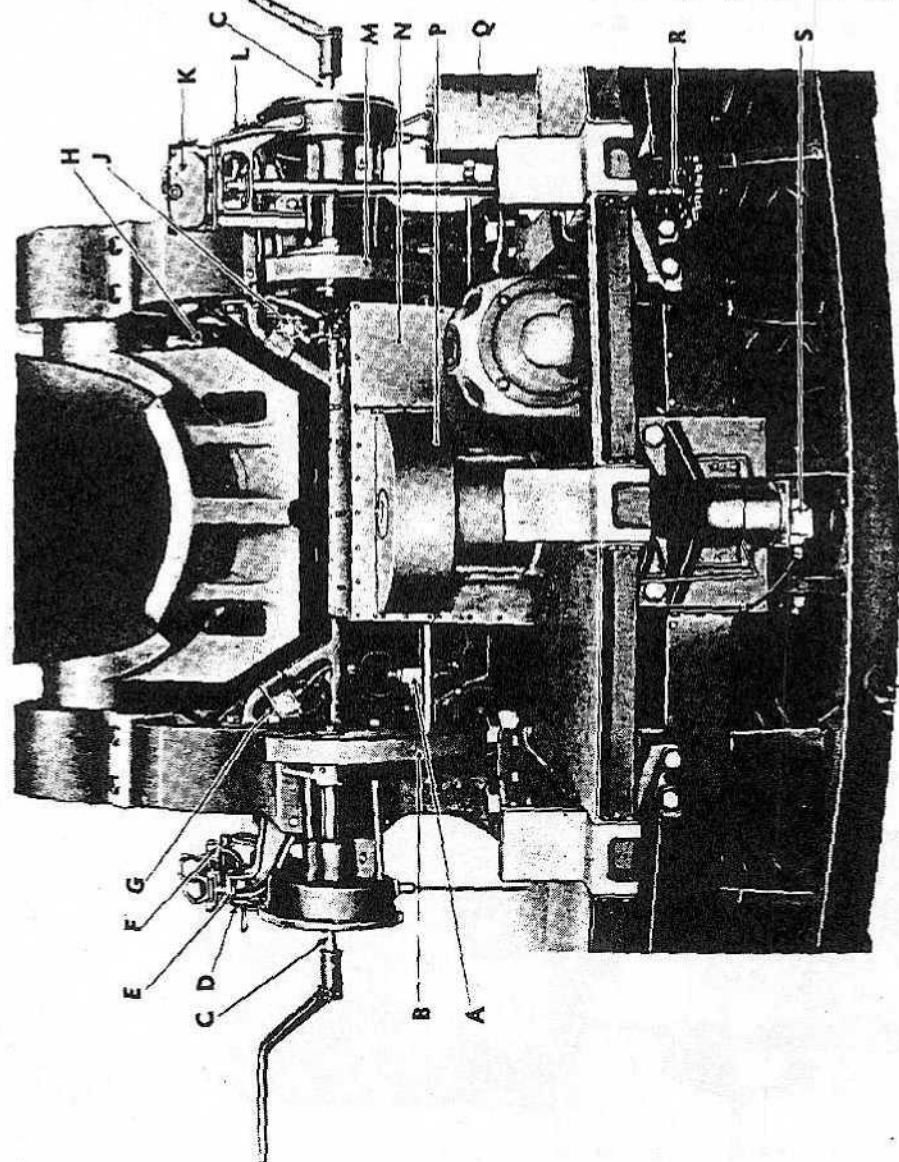

Figure 90—Front View with Shield Removed (Gun Elevated)

RA PD 38778



**16-INCH SEACOAST GUN MATERIEL  
GUN MK. II M1; BARBETTE CARRIAGE M4**

- A—GROUTING AIR VENT
- B—TRAVERSING CRANK B162950
- C—(SLOW MOTION CLUTCH) CONNECTING ROD B162941
- D—(SLOW-MOTION CLUTCH) TREADLE B162971
- E—TRAVERSING CRANK SHAFT (ASSEMBLY) B163053
- F—TRAVERSING SLOW-MOTION HANDWHEEL ASSEMBLY (RIGHT) D42564
- G—SIGHT MOUNTING BRACKET (LEFT) D42614A (RIGHT) D42614B
- H—TRANSVERSE SHAFT C54835
- J—TRAVERSING GEAR FRICTION BOX ASSEMBLY D42527
- K—TRAVERSING CLUTCH SHIFTER C3019
- L—TRAVERSING SHIFT LEVER ASSEMBLY D42601
- M—TRAVERSING SLOW-MOTION HANDWHEEL (LEFT) D42524
- N—UPPER INDICATOR SHAFT C54837
- P—SPEED GEAR CONTROL STOP ASSEMBLY C87162
- Q—VERTICAL CONTROL SHAFT PEDESTAL C54839
- R—HORIZONTAL CONTROL SHAFT C87161
- S—LEVELLING SCREW (OUTER) A149781
- T—LEVELLING PLATE B162987
- U—TRAVERSING PINION C54829
- V—TRAVERSING BRACKET D42198
- W—TRAVERSING LIMIT SWITCH C87140

RA PD 38779

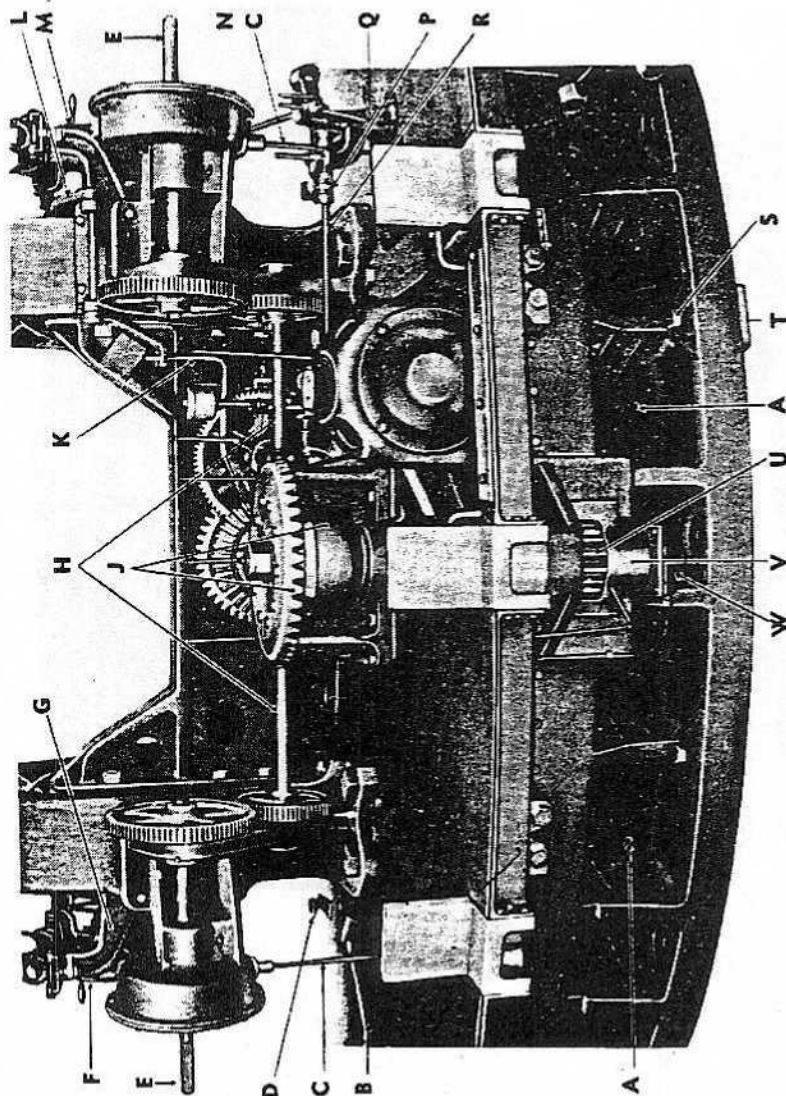

**Figure 91—Traversing Mechanism**

**DESCRIPTION AND FUNCTIONING**

1. **Traversing Group.** The traversing mechanism enables the gunners to traverse the mount through its maximum permissible movement of 145 degrees so as to point the gun at any given target within its field of fire. The mount can be traversed by power or by hand as the occasion requires.

(1) **TRAVERSING PINION AND RACK.** The traversing bracket (V, fig. 91), bolted to the racer, houses the traversing pinion (U, fig. 91) and shaft. The pinion meshes with the traversing rack (K, fig. 30), fastened to the stationary base ring, so that rotation of the pinion causes the mount to revolve on the traversing rollers.

(2) **TRAVERSING GEAR-FRICTION BOX ASSEMBLY.**

(a) A traversing gear-friction device protects the traversing mechanism against excessive strain, due to abrupt starting or sudden stopping of the weight traversed, and provides positive drive of the traversing pinion within safe limits of strain.

(b) A multi-disk clutch inside of the friction disk oil container in the friction box assembly (J, fig. 91) limits the force or strain transmitted through the friction device to the grip of this clutch. Friction is accurately maintained at the desired point by pressing together the disks of the multi-disk clutch by means of Belleville springs and by lubricating the disk surfaces. Lubrication is accomplished by filling the friction disk oil container with oil. The traversing shaft nut (R, fig. 92) is used to adjust the compression of the Belleville springs and in this manner to control the grip of the multi-disk clutch (fig. 141). A screw (T, fig. 92) locks the traversing shaft nut in position.

(3) **TRAVERSING CLUTCH.**

(a) The traversing clutch (AA, fig. 92) provides alternative mechanical connection to the traversing pinion either for the traversing crankshafts (E, fig. 91) or for the traversing speed gear and so provides for either hand or power traversing of the mount.

(b) The traversing clutch is keyed to the clutch shaft which drives the friction box gear (U, fig. 92) connected to the traversing pinion.

(4) **TRAVERSING CLUTCH SHIFTER.** A traversing clutch shifter (E, fig. 92) slides the clutch on the clutch shaft so as to engage either the clutch bevel gear (Z, fig. 92) or the clutch spur gear (B, fig. 92). Both gears turn freely on the clutch shaft when disengaged from the clutch. A train of gears connects the clutch bevel gear to each traversing crankshaft (E, fig. 91). The clutch spur gear is driven by the traversing speed gear through another gear train.

(a) A traversing shift lever (L, fig. 91, and N, fig. 94), located on the left side of the frame, operates the clutch shifter from a position which

**16-INCH SEACOAST GUN MATERIEL  
GUN MK. II M1; BARBETTE CARRIAGE M4**

is readily accessible to the azimuth operator at the left side of the mount (fig. 139).

(b) When operating by hand, a spring plunger in the shift lever handle (L, fig. 93) must be engaged in the upper hole marked "HAND" in the locking bracket (Q, fig. 94). When operating by power, the lever handle plunger must be engaged in the lower hole, marked "POWER" in the locking bracket (fig. 138).

(5) **TRAVERSING CRANKS.** Traversing cranks assembled on crankshafts on the right and left sides of the carriage are used to swing the gun rapidly from one target to another. Direction plates (H, fig. 94) on each crankshaft bracket cover (E, fig. 93) indicate the direction of rotation of the crank to traverse the piece to the right or left.

(6) **TRAVERSING SLOW-MOTION HANDWHEELS.**

(a) Accurate adjustment of azimuth is accomplished by using the traversing slow-motion handwheels (fig. 141) of which there are two sets, one (U, fig. 95) and (fig. 97) on the right side and one (M, fig. 93) and (fig. 96) on the left side of the carriage. Either the right-side or left-side traversing slow-motion handwheels may be used as the occasion requires, but they cannot be used simultaneously. A direction plate on the outer handwheel of each traversing slow-motion mechanism indicates the direction of rotation of the handwheels to traverse the piece to the right or left.

(b) A clutch (H, fig. 98) in each slow-motion crankshaft bracket (E, fig. 98) engages and disengages the adjacent traversing slow-motion mechanism. The clutches are operated by rods (A, fig. 98, and C, fig. 91) which are connected with the clutch treadles (D, fig. 91, and M, fig. 99) by shafts and levers under the platform. A counterweight (D, fig. 80, and L, fig. 99) keeps each treadle raised when unlatched. Fully depressing the treadle engages the traversing slow-motion mechanism only on the side of the carriage where the operation takes place. The treadle is locked in this position by pushing it outward from the center of the carriage so as to engage the dog on the treadle with the latch plate (N, fig. 99). The treadle is released by kicking it inward towards the center of the carriage. The counterweight raises the treadle and so disengages the slow-motion clutch connected to it.

(7) **TRAVERSING SPEED GEAR.** The traversing pinion may be driven at varying speeds in either direction or held motionless by the hydraulic speed gear while the motor end of the speed gear is driven at constant

## DESCRIPTION AND FUNCTIONING

speed and in one direction only. When traversing by power, the motor supplies the power for the traversing pinion but the speed of the pinion is controlled by the traversing hydraulic speed gear operating through the horizontal control shaft (R, fig. 91, and U, fig. 100).

### (8) TRAVERSING CONTROL STATIONS.

(a) A group of bevel gears (fig. 100) connects the horizontal control shaft (U, fig. 100) to the two control handwheels (F and K, figs. 102). The lower end of the vertical shaft is provided with bevel gears (C, fig. 101) connecting with the lower indicator shaft (D, fig. 101). This arrangement permits the power traversing of the gun to be controlled from either of two stations—the azimuth observer's cab (M, fig. 102) or the left side azimuth operator's station. From the azimuth observer's cab the gun may be traversed by power (fig. 143) to any desired reading of the azimuth indicator (G, fig. 103). The azimuth operator on the left side of the mount can read the azimuth data indicator (K, fig. 94) from his position while traversing the gun. He is able to operate according to the reading on the data receiver of the azimuth data indicator or he can lay the piece to an azimuth reading as occasion requires.

(b) Markings on the traversing control gear cases (B, fig. 103, and R, fig. 93) of each traversing control mechanism indicate the direction in which the control handwheel (D, fig. 103, and T, fig. 94) is to be moved from neutral position in order to traverse the mount to the right or left. When the zero mark on the indicator dial (C, fig. 103, and Q, fig. 93) coincides with the index line on the gear case, the traversing control is in neutral position and the speed gear holds the traversing pinion motionless. The traversing control mechanism (fig. 103) is shown in neutral position. The graduations marked "one-fourth, one-half, three-fourths and full speed" at each side of the zero mark indicate the traversing speed at which the control is set when they coincide with the index line on the gear case.

(9) TRAVERSING LIMIT SWITCH. The power traversing of the piece is stopped by a traversing limit switch (S, fig. 90) and (fig. 104) breaking the electric current to the traversing motor when the mount approaches its limit of traverse in either direction. It is mounted on a plate (K, fig. 104) at the bottom of the traversing bracket (C, fig. 104). Near the limit of traverse in either direction, a limit switch stop rail, of which there are two (B, fig. 104), engages the cam wheel (R, fig. 104) of the limit switch, forcing the operating lever arm (Q, fig. 104) to swing back, thereby operating the switch. A slight movement of the limit switch

**16-INCH SEACOAST GUN MATERIEL  
GUN MK. II M1; BARBETTE CARRIAGE M4**

operating lever arm in either direction from its normal central position will operate the switch so as to deenergize the traversing motor.

(a) The limit switch stop rails are so located on the base ring as to break the electric circuit when the carriage has traversed 66 degrees in either direction from the center lines of the emplacement.

(b) After the limit switch has stopped the traversing of the piece, and so long as the limit switch cam wheel is in contact with the stop rail, the traversing motor can be started and kept running only by keeping the limit switch button at the traversing push-button station (E, fig. 154) depressed. Before restarting the motor, the traversing control must be set at neutral. If the mount is to be rotated beyond the point where the limit switch has stopped the movement in azimuth, caution must be exercised and the traversing control must be so operated as to obtain a very limited traversing speed. Generally, it will be advisable to continue traverse in the same direction by using slow-motion hand power. (See Limits of Traverse, par. 9 j (2)).

(10) **AZIMUTH DATA INDICATOR.** The operator in the azimuth observer's cab can only lay the piece to an azimuth reading on the azimuth circle. The azimuth data indicator (K, fig. 94), located near the left traversing handwheels, is for tracking in azimuth with off-carriage fire-control instruments which transmit azimuths mechanically to one of the dials of the indicator. The azimuth data indicator contains two sets of pointers, one operated electrically and one by mechanical means. The electrical pointer is controlled and operated from the off-carriage station in conjunction with the fire-control system. The mechanical pointer is operated through a drive mechanism (R, fig. 90) and is driven from the traversing rack by the azimuth indicator gears (C and D, fig. 105). As the mount is traversed the rotation is transmitted to the mechanical pointer of the azimuth data indicator showing the exact position of the gun in azimuth.

(11) **ZERO ADJUSTING DEVICE.** A zero adjusting device (F and G, fig. 105) permits adjustment of the drive mechanism of the azimuth data indicator so as to bring the readings of the azimuth data indicator and the azimuth indicator in the observer's cab into alinement. The zero adjusting device also eliminates backlash at the traversing rack so that the readings of the azimuth data indicator are not affected by the direction of traverse of the mount.

m. Power, lighting and firing circuit groups are covered in detail under section VIII.

DESCRIPTION AND FUNCTIONING

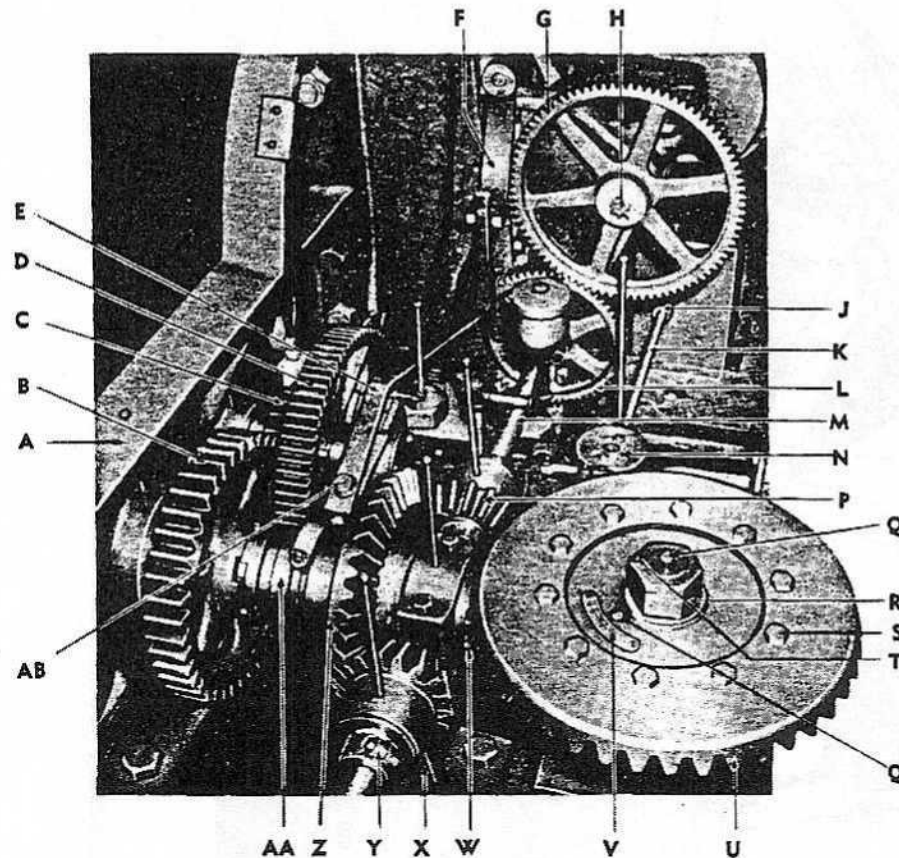

- |   |  |
|---|--|
| A—FRONT TRANSOM D89   | P —TRANSVERSE SHAFT PINION<br>B162968                      |
| B—CLUTCH SPUR GEAR C54845   | Q —OIL PLUG A8056  |
| C—POWER COUNTERSHAFT<br>PINION B162981                                | R —VERTICAL TRAVERSING<br>SHAFT NUT A149718                |
| D—POWER COUNTERSHAFT<br>GEAR C54849                                   | S —FRICTION BOX GEAR BOLT<br>A149192                       |
| E—CLUTCH SHIFTER<br>(ASSEMBLY) D42627                                 | T —(NUT) LOCKING SCREW<br>BCAX1CD                          |
| F—SHIFT LEVER<br>(ASSEMBLY) D42601                                    | U —FRICTION BOX GEAR D42261                                |
| G—CRANK SHAFT GEAR C54834   | V —INSTRUCTION PLATE B162945<br>WITH SCREWS BCLX21CD       |
| H—CRANKSHAFT (ASSEMBLY) B163053<br>WITH NUT BBGX2E<br>AND PIN BFAX2AB | W —CLUTCH SHAFT FRICTION<br>GEAR PINION B162963            |
| J —SPEED GEAR CONTROL STOP<br>(ASSEMBLY) C87162                       | X —COUNTERSHAFT BRACKET<br>C54848                          |
| K—HORIZONTAL CONTROL<br>SHAFT C87161                                  | Y —COUNTERSHAFT THRUST<br>COLLAR (ASSEMBLY) B162965A AND B |
| L—TRANSVERSE SHAFT GEAR<br>C54852                                     | Z —CLUTCH BEVEL GEAR C54844                                |
| M—TRANSVERSE SHAFT C54835   | AA—TRAVERSING CLUTCH C54843                                |
| N—TRAVERSING DETENT<br>(ASSEMBLY) D42567                              | AB—CLUTCH SHIFTER BOLT<br>A149751                          |

RA PD 38780

Figure 92—Traversing Gearing

16-INCH SEACOAST GUN MATERIEL  
GUN MK. II M1; BARBETTE CARRIAGE M4

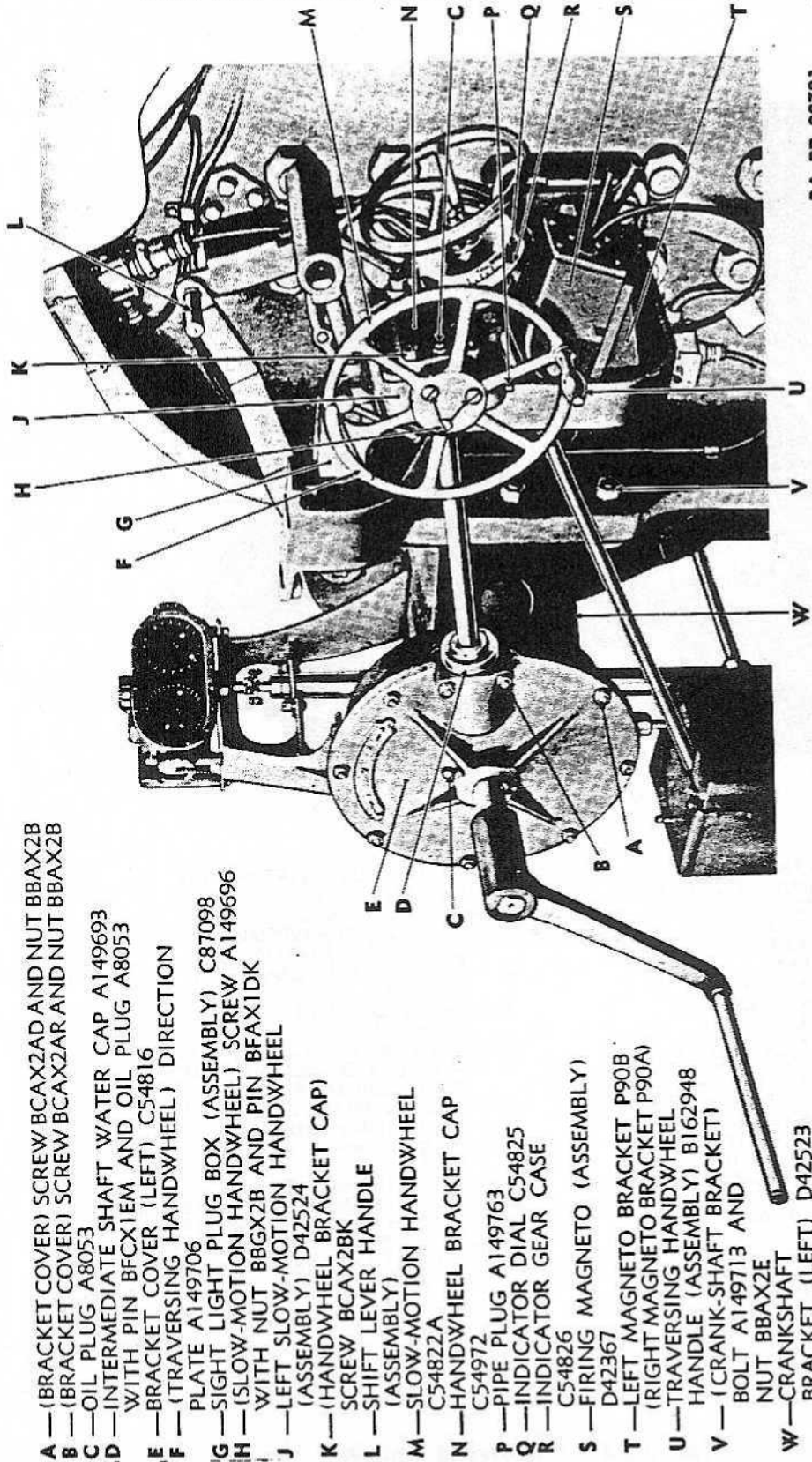

RA PD 38781

- A — (BRACKET COVER) SCREW BCAX2AD AND NUT BBAX2B
- B — (BRACKET COVER) SCREW BCAX2AR AND NUT BBAX2B
- C — OIL PLUG A8053
- D — INTERMEDIATE SHAFT WATER CAP A149693 WITH PIN BFCX1EM AND OIL PLUG A8053
- E — BRACKET COVER (LEFT) C54816
- F — (TRAVERSING HANDWHEEL) DIRECTION PLATE A149706
- G — SIGHT LIGHT PLUG BOX (ASSEMBLY) C87098
- H — (SLOW-MOTION HANDWHEEL) SCREW A149696 WITH NUT BGGX2B AND PIN BFAK1DK
- J — LEFT SLOW-MOTION HANDWHEEL (ASSEMBLY) D42524
- K — (HANDWHEEL BRACKET CAP) SCREW BCAX2BK
- L — SHIFT LEVER HANDLE (ASSEMBLY)
- M — SLOW-MOTION HANDWHEEL C54822A
- N — HANDWHEEL BRACKET CAP C54972
- P — PIPE PLUG A149763
- Q — INDICATOR DIAL C54825
- R — INDICATOR GEAR CASE C54826
- S — FIRING MAGNETO (ASSEMBLY) D42367
- T — LEFT MAGNETO BRACKET P90B (RIGHT MAGNETO BRACKET P90A)
- U — TRAVERSING HANDWHEEL HANDLE (ASSEMBLY) B162948
- V — (CRANK-SHAFT BRACKET) BOLT A149713 AND NUT BBAX2E
- W — CRANKSHAFT BRACKET (LEFT) D42523

Figure 93—Left Traversing Crank and Handwheels

DESCRIPTION AND FUNCTIONING

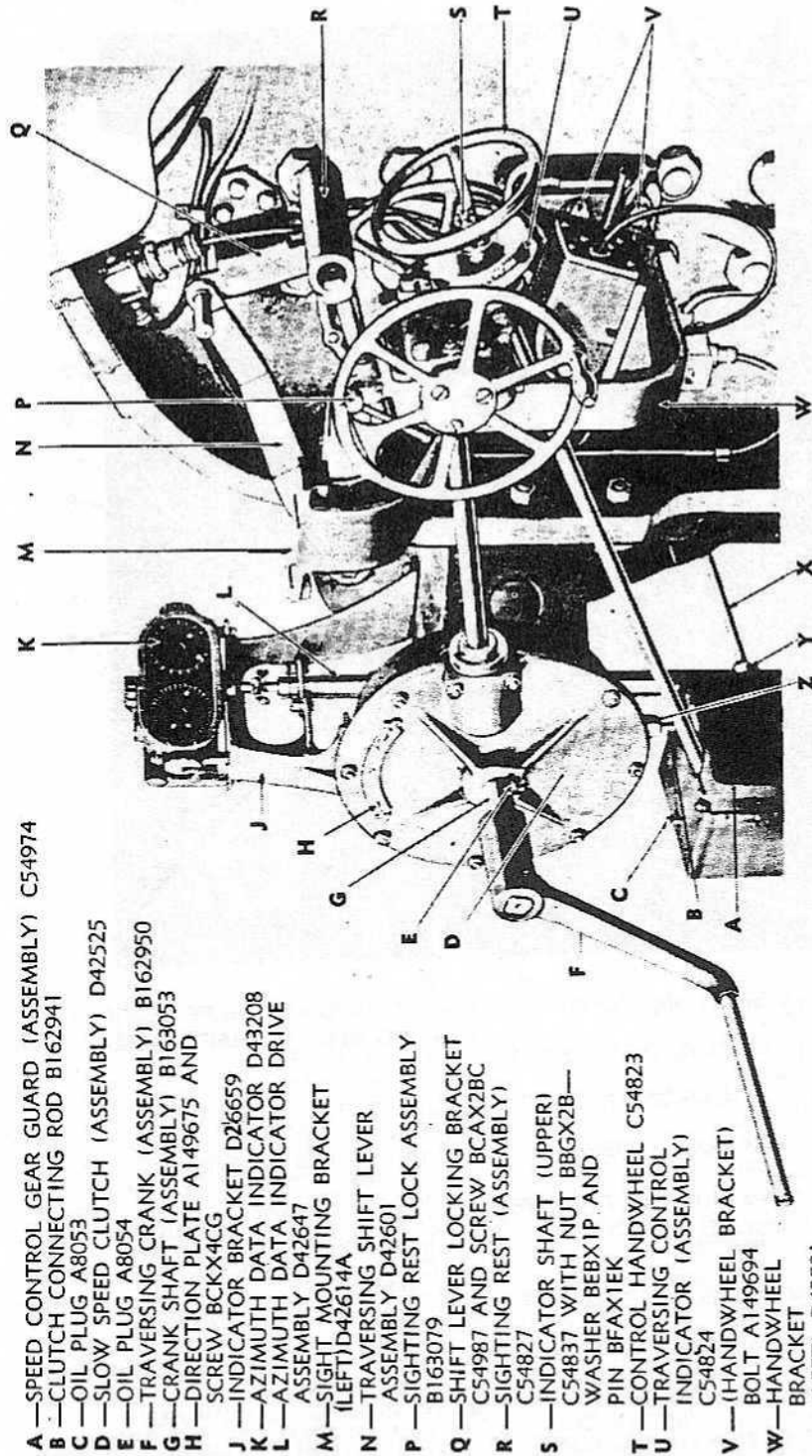

RA PD 38782

- A — SPEED CONTROL GEAR GUARD (ASSEMBLY) C54974
- B — CLUTCH CONNECTING ROD B162941
- C — OIL PLUG A8053
- D — SLOW SPEED CLUTCH (ASSEMBLY) D42525
- E — OIL PLUG A8054
- F — TRAVERSING CRANK (ASSEMBLY) B162950
- G — CRANK SHAFT (ASSEMBLY) B163053
- H — DIRECTION PLATE A149675 AND SCREW BCKX4CG
- J — INDICATOR BRACKET D26659
- K — AZIMUTH DATA INDICATOR D43208
- L — AZIMUTH DATA INDICATOR DRIVE ASSEMBLY D42647
- M — SIGHT MOUNTING BRACKET (LEFT) D42614A
- N — TRAVERSING SHIFT LEVER ASSEMBLY D42601
- P — SIGHTING REST LOCK ASSEMBLY B163079
- Q — SHIFT LEVER LOCKING BRACKET C54987 AND SCREW BCAX2BC
- R — SIGHTING REST (ASSEMBLY) C54827
- S — INDICATOR SHAFT (UPPER) C54837 WITH NUT BBGX2B— WASHER BEBXIP AND PIN BFAX1EK
- T — CONTROL HANDWHEEL C54823
- U — TRAVERSING CONTROL INDICATOR (ASSEMBLY) C54824
- V — (HANDWHEEL BRACKET) BOLT A149694
- W — HANDWHEEL BRACKET (LEFT) D42521
- X — HORIZONTAL CONTROL SHAFT C87161
- Y — SPEED GEAR CONTROL STOP (ASSEMBLY) C87162
- Z — CLUTCH SPRING RETAINER B162944

Figure 94—Left Traversing Crank and Handwheels



**16-INCH SEACOAST GUN MATERIEL  
GUN MK. II M1; BARBETTE CARRIAGE M4**

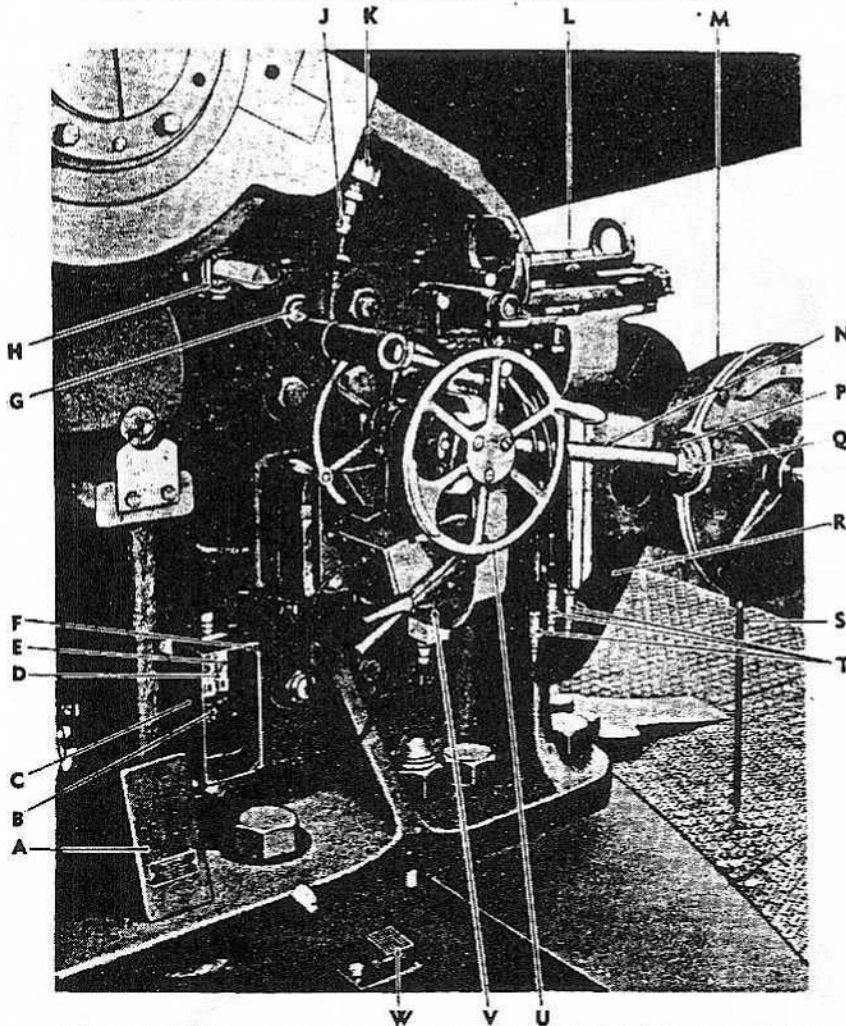

- |   |   |
|---|---|
| A — TRANSFORMER BOX COVER<br>C87120   | N — INTERMEDIATE SHAFT C54819   |
| B — SIGHT LIGHTING TRANSFORMER<br>B162586   | P — INTERMEDIATE SHAFT WATER<br>CAP A149693   |
| C — SIGHT LIGHTING TRANSFORMER<br>BOX D42352  | Q — OIL PLUG A8053  |
| D — CARTRIDGE FUSE A217899A<br>(3 AMPERE)   | R — CRANKSHAFT GEAR GUARD<br>(RIGHT) D42581   |
| E — TRANSFORMER CUT-OUT A217898   | S — TRAVERSING HANDWHEEL<br>CLUTCH CONNECTING ROD<br>B162941                                  |
| F — (TRANSFORMER BOX COVER)<br>SCREW BCNX4BE  | T — SIGHT LIGHT HOLDER E109F (ON<br>INDEX-CABLE—CROSS-WIRE<br>CABLE AND MICROMETER-<br>CABLE) |
| G — (SIDE FRAME AND FRONT<br>TRANSOM) BOLT B162774 AND<br>NUT BBAX3E                                | U — SLOW-MOTION HANDWHEEL<br>(ASSEMBLY) D42564  |
| H — LAMP RECEPTACLE BOX B162529   | V — RIGHT MAGNETO BRACKET P90B<br>(LEFT P90A)   |
| J — FIRING CIRCUIT PLUG B160200   | W — TRAVERSING HANDWHEEL<br>CLUTCH TREADLE B162971 WITH<br>PLATE A149729 — SCREW/<br>BCAX2BB  |
| K — FIRING CIRCUIT PLUG BOX<br>WITH COVER — RECEPTACLE<br>HOUSING B128000 AND CON-<br>DULET B127998 |   |
| L — TELESCOPE MOUNT 15-2A43-2   |   |
| M — SLOW SPEED CLUTCH<br>(ASSEMBLY) D42525  |   |

RA PD 38783

**Figure 95—Right Firing Magneto—Sight Lighting Transformer  
Slow-motion Traversing Handwheels and Clutch Treadle**

DESCRIPTION AND FUNCTIONING

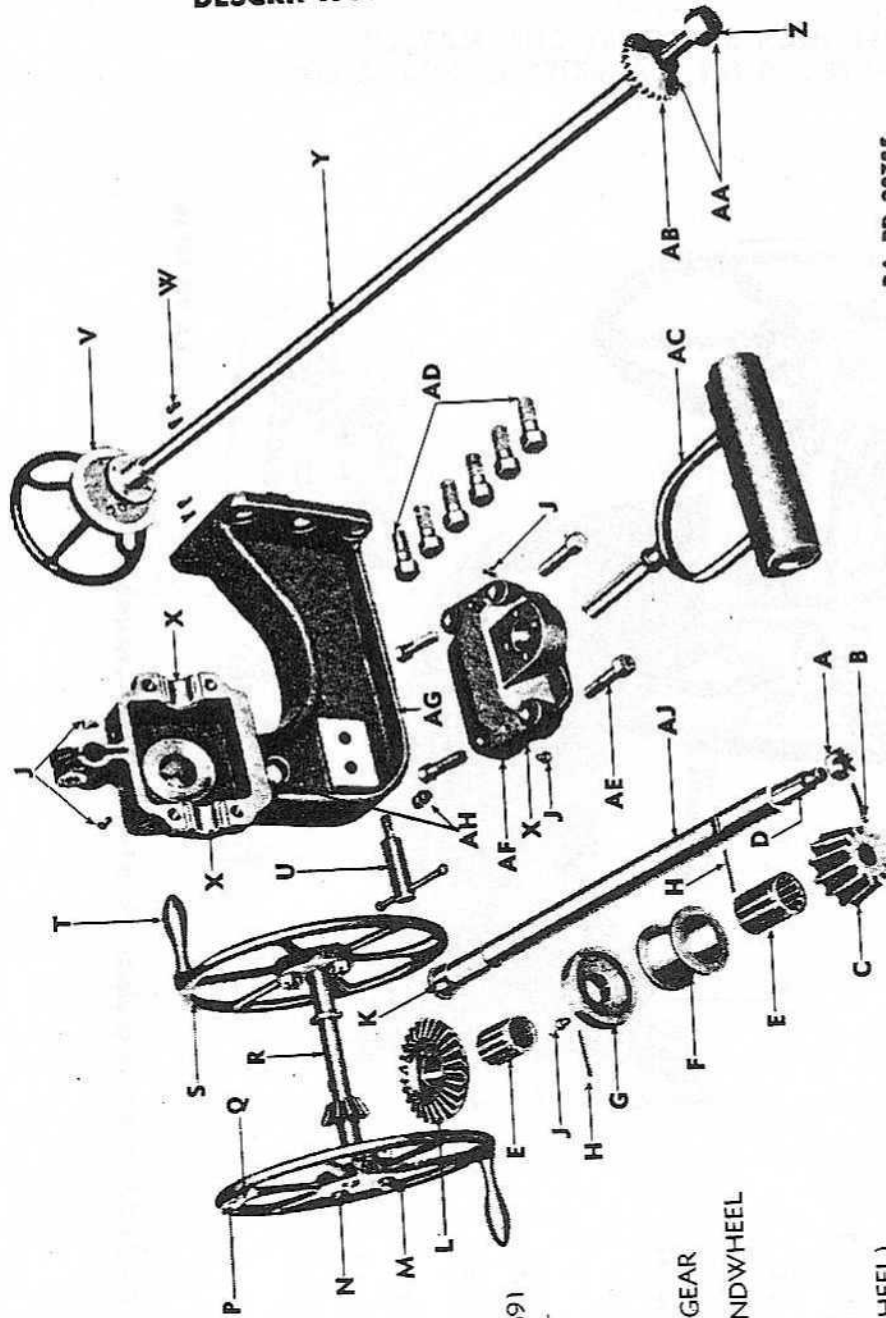

RA PD 38785

- A—NUT BBGX2C
  - B—COTTER PIN BFAX1EL
  - C—INTERMEDIATE SHAFT
  - D—PINION B162940
  - E—FLAT KEY A149690
  - F—ROLLER BEARING A149691
  - G—ROLLER BEARING SHELL A149715
  - H—WATER CAP A149693
  - I—TAPER PIN BFCX1EM
  - J—OIL PLUG A8053
  - K—FLAT KEY A149689
  - L—INTERMEDIATE SHAFT GEAR C54820
  - M—TRAVERSING OUTER HANDWHEEL C54822A
  - N—SCREW A149696
  - O—NUT BBGX2B
  - P—COTTER PIN BFAX1DK
  - Q—SCREW BCKX4AE
  - R—(TRAVERSING HANDWHEEL) DIRECTION PLATE A149706
- (CONTINUED ON OPPOSITE PAGE)

Figure 96—Left Traversing Handwheel Parts and Control Handwheel

16-INCH SEACOAST GUN MATERIEL  
GUN MK. II M1; BARBETTE CARRIAGE M4

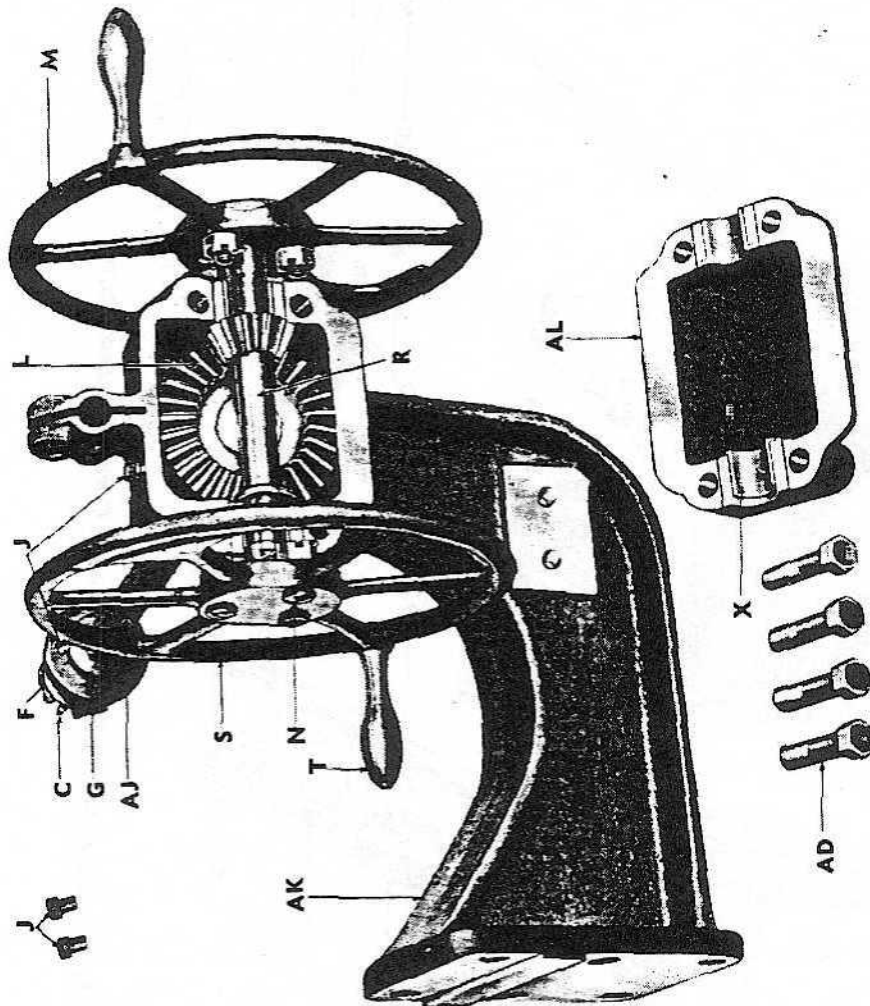

RA PD 38786

- (A TO Q LISTED ON PRECEDING PAGE)
- R — HANDWHEEL SHAFT C54821
  - S — TRAVERSING INNER HANDWHEEL C54822B
  - T — TRAVERSING HANDWHEEL HANDLE ASSEMBLY B162948
  - U — SIGHTING REST LOCK ASSEMBLY B163079
  - V — TRAVERSING CONTROL INDICATOR ASSEMBLY C54824
  - W — SCREW BCBX1CB
  - X — HALF BUSHING A149695 AND PIN BFDX6EG
  - Y — UPPER INDICATOR SHAFT C54837
  - Z — SHAFT COLLAR A149734
  - AA — TAPER PIN BECX1CG
  - AB — UPPER INDICATOR SHAFT GEAR B162972
  - AC — SIGHTING REST ASSEMBLY C54827
  - AD — BOLT A149694
  - AE — SCREW BCAX2BK
  - AF — LEFT TRAVERSING HANDWHEEL BRACKET CAP C54973
  - AG — LEFT TRAVERSING HANDWHEEL BRACKET D42521
  - AH — PIPE PLUG A149763
  - AJ — TRAVERSING INTERMEDIATE SHAFT C54819
  - AK — RIGHT TRAVERSING HANDWHEEL BRACKET D42520
  - AL — RIGHT TRAVERSING HANDWHEEL BRACKET CAP C54972

Figure 97 — Right Traversing Handwheel — Partially Assembled View

DESCRIPTION AND FUNCTIONING

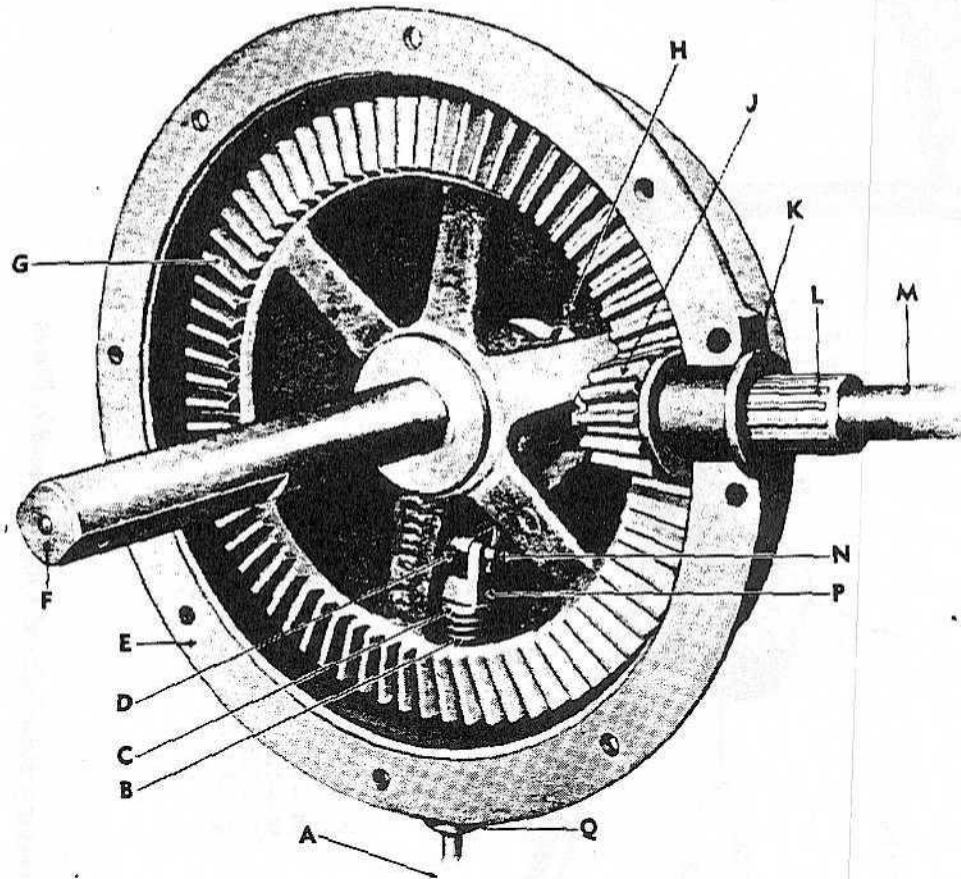

- A—CLUTCH CONNECTING ROD  
B162941
- B—CLUTCH SPRING A149677
- C—WASHER A149680
- D—CLUTCH FORK B162943
- E—LEFT CRANKSHAFT BRACKET  
D42523
- F—CRANKSHAFT ASSEMBLY  
B163053
- G—CRANKSHAFT GEAR C54817
- H—SLOW-MOTION CLUTCH  
B162939
- J—TRAVERSING INTERMEDIATE  
SHAFT PINION B162940

- K—BEARING SHELL A149715
- L—ROLLER BEARING A149691  
(SHOWN PARTIALLY  
WITHDRAWN)
- M—TRAVERSING INTERMEDIATE  
SHAFT C54819
- N—PIN BFEX2BG AND  
COTTER PIN BFAX1EL
- P—CONNECTING ROD END  
A149679
- Q—CLUTCH SPRING RETAINER  
B162944

RA PD 38787

Figure 98—Traversing Handwheel Clutch—Exposed View

16-INCH SEACOAST GUN MATERIEL  
GUN MK. II M1; BARBETTE CARRIAGE M4

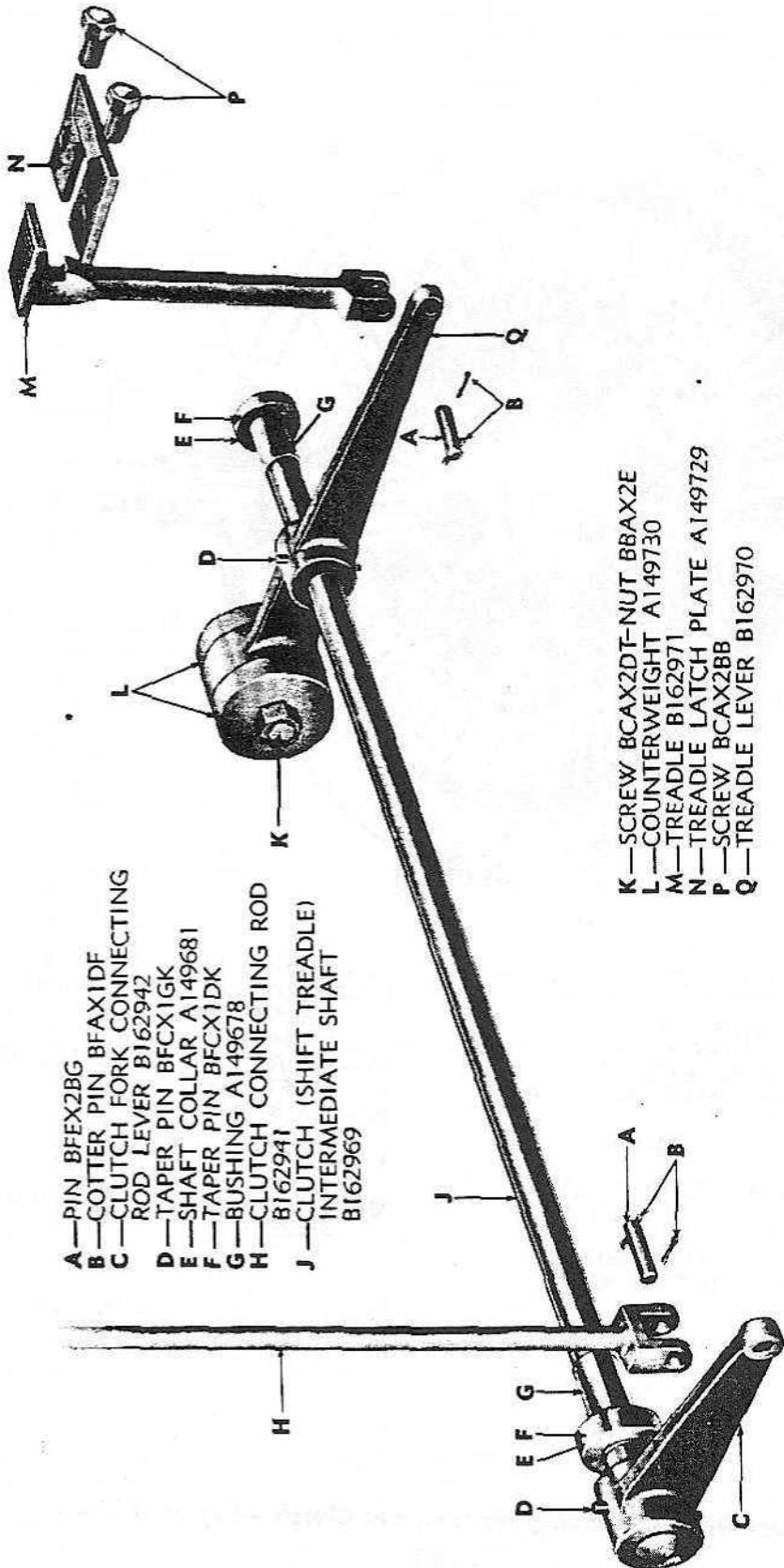

- A—PIN BFEX2BG
- B—COTTER PIN BFAX1DF
- C—CLUTCH FORK CONNECTING ROD LEVER B162942
- D—TAPER PIN BFCX1GK
- E—SHAFT COLLAR A149681
- F—TAPER PIN BFCX1DK
- G—BUSHING A149678
- H—CLUTCH CONNECTING ROD B162941
- J—CLUTCH (SHIFT TREADLE) INTERMEDIATE SHAFT B162969

- K—SCREW BCAX2DT-NUT BBAX2E
- L—COUNTERWEIGHT A149730
- M—TREADLE B162971
- N—TREADLE LATCH PLATE A149729
- P—SCREW BCAX2BB
- Q—TREADLE LEVER B162970

RA PD 38788

Figure 99—Traversing Handwheel Clutch Treadle Parts

DESCRIPTION AND FUNCTIONING

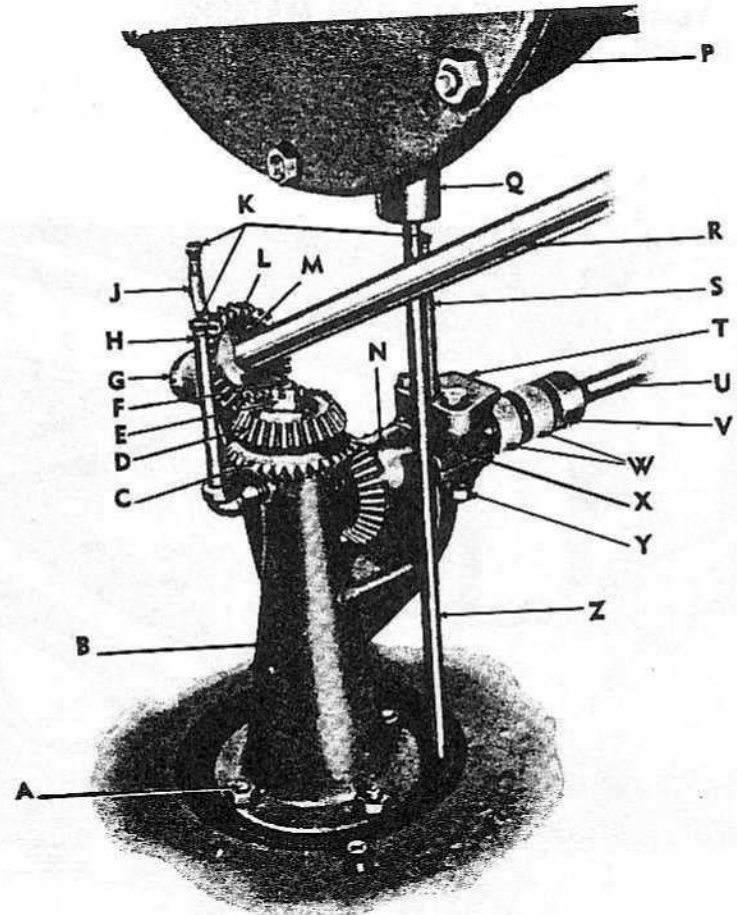

- A—NUT BBAX1E AND SCREW BCAX1EF
- B—VERTICAL CONTROL SHAFT PEDESTAL C54839
- C—VERTICAL CONTROL SHAFT GEAR B162978
- D—VERTICAL CONTROL SHAFT GEAR B162973
- E—NUT BBGX2B AND PIN BFAX1EK
- F—VERTICAL CONTROL SHAFT C54842
- G—SHAFT COLLAR A149734 AND PIN BFCX1CG
- H—OIL PIPING ASSEMBLY A149965
- J—OIL PIPE A149731C
- K—OIL PLUG A8053
- L—UPPER INDICATOR SHAFT GEAR B162972
- M—KEY BGHX1JF
- N—HORIZONTAL CONTROL SHAFT PINION B162977

- P—LEFT CRANKSHAFT BRACKET D42523
- Q—CLUTCH SPRING RETAINER B162944
- R—UPPER INDICATOR SHAFT C54837
- S—OIL PIPE A149731B
- T—SPEED GEAR CONTROL STOP BRACKET B187117
- U—HORIZONTAL CONTROL SHAFT C87161
- V—SPEED GEAR CONTROL STOP SLEEVE A218003 AND TAPER PIN BFCX1FG
- W—SPEED GEAR CONTROL STOP COLLAR A218002
- X—PEDESTAL CAP B163192
- Y—SCREW BCAX1EP AND NUT BBAX1E
- Z—CLUTCH CONNECTING ROD B162941

RA PD 38789

Figure 100—Upper Traversing Control Gears

16-INCH SEACOAST GUN MATERIEL  
GUN MK. II M1; BARBETTE CARRIAGE M4

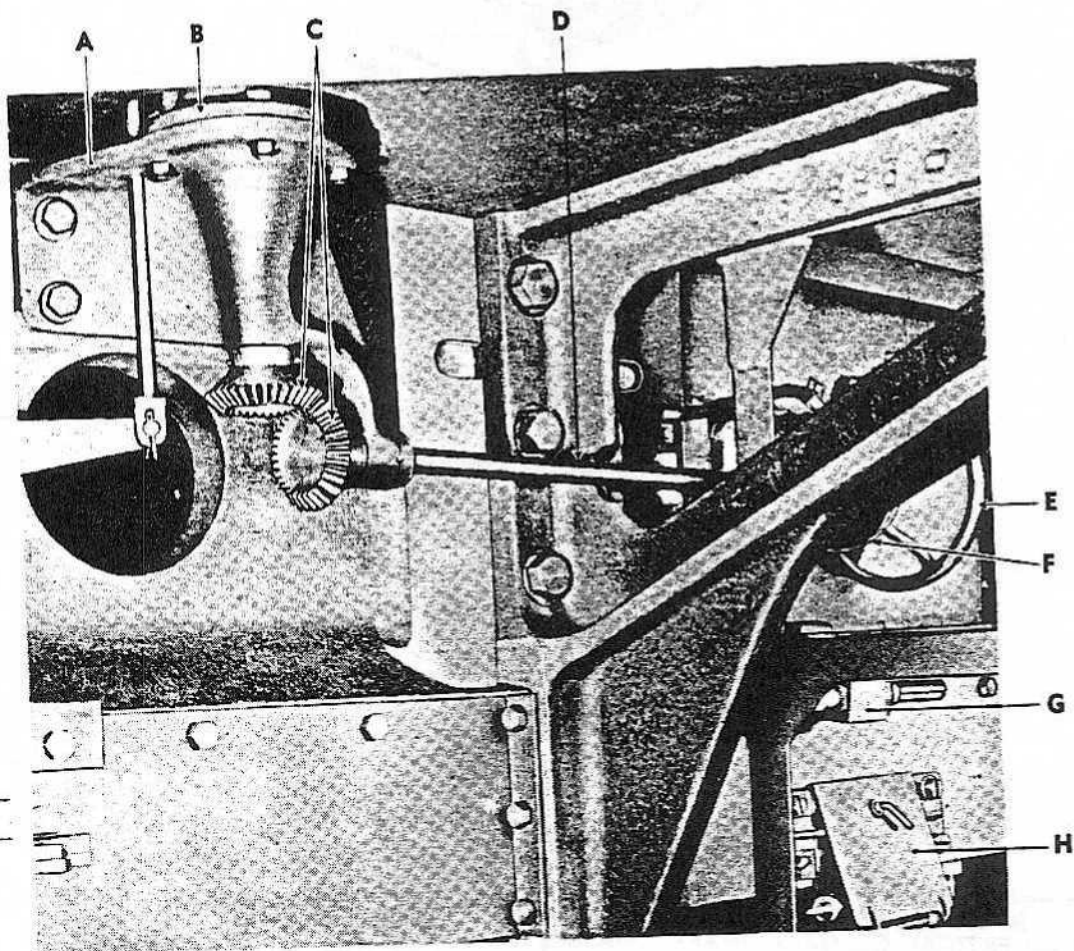

- A—VERTICAL CONTROL SHAFT BRACKET C54840
- B—VERTICAL CONTROL SHAFT PEDESTAL C54839
- C—LOWER INDICATOR SHAFT GEARS B162974 AND PIN BFCX1DK
- D—LOWER INDICATOR SHAFT C54838
- E—CONTROL HANDWHEEL C54823

- F—TRAVERSING CONTROL INDICATOR (ASSEMBLY) C54824
- G—LAMP JUNCTION BOX E107M AND LAMP E110C
- H—AZIMUTH INDICATOR ASSEMBLY D42552

RA PD 38790

Figure 101—Azimuth Observer's Cab Traversing Control Bevel Gears

## DESCRIPTION AND FUNCTIONING

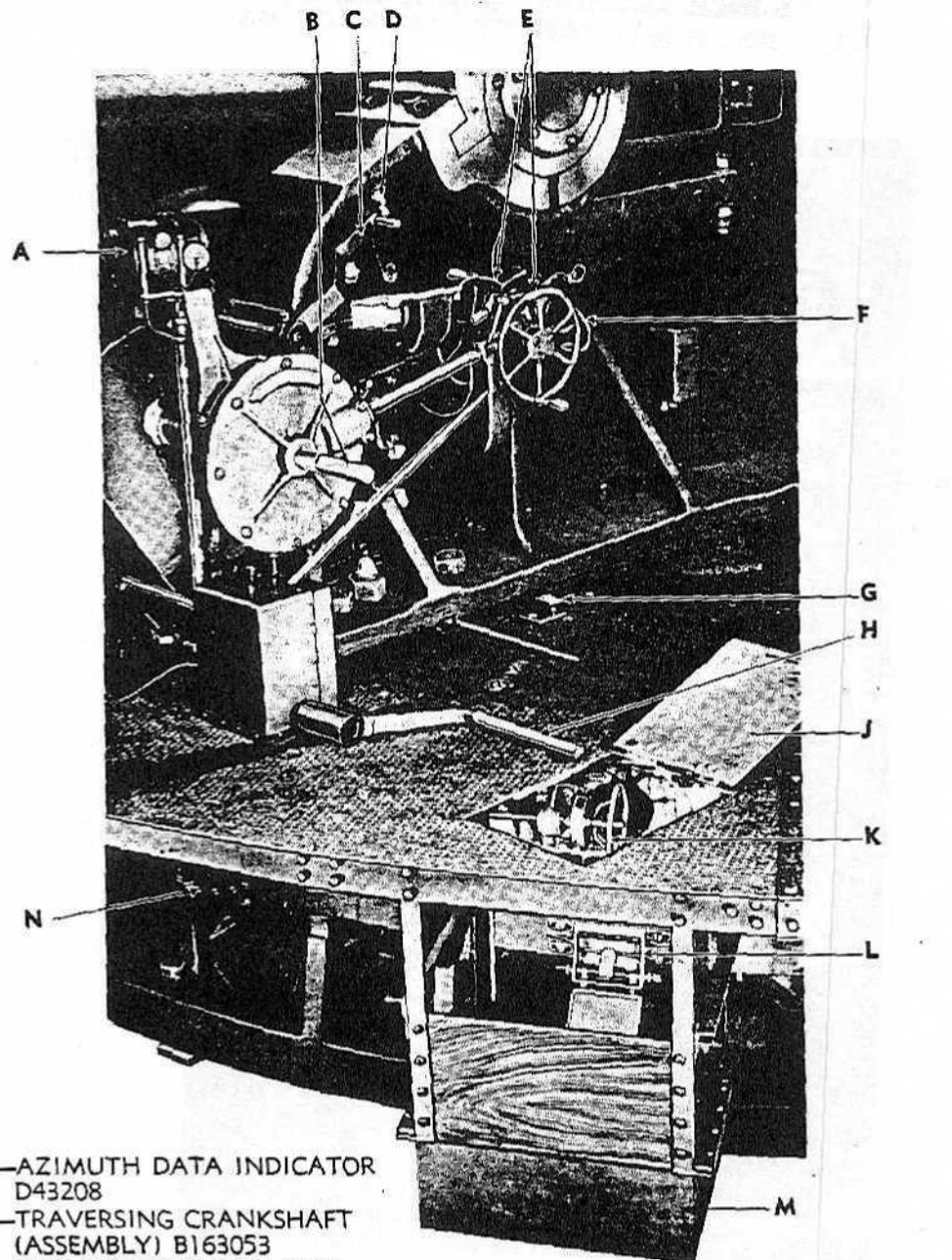

A—AZIMUTH DATA INDICATOR  
D43208

B—TRAVERSING CRANKSHAFT  
(ASSEMBLY) B163053

C—TRAVERSING SHIFT LEVER  
C54989

D—MAGNETO PLUG B160200

E—TRAVERSING SLOW-MOTION  
HANDWHEELS C54822A AND  
C54822B

F—UPPER TRAVERSING CONTROL  
HANDWHEEL C54823

G—TRAVERSING SLOW-MOTION  
HANDWHEEL CLUTCH TREADLE  
B162971

H—TRAVERSING CRANK B162950

J—PLATFORM DOOR (ASSEMBLY)

K—LOWER TRAVERSING CONTROL  
HANDWHEEL C54823

L—AZIMUTH INDICATOR D42552

M—AZIMUTH OBSERVER'S CAB  
D42565

N—AZIMUTH INDICATOR GEARS  
(FIXED) C53305 AND (LOOSE)  
C53306

RA PD 38791

**Figure 102—Azimuth Observer's Cab and Both Traversing  
Speed-gear Controls**



16-INCH SEACOAST GUN MATERIEL  
GUN MK. II M1; BARBETTE CARRIAGE M4

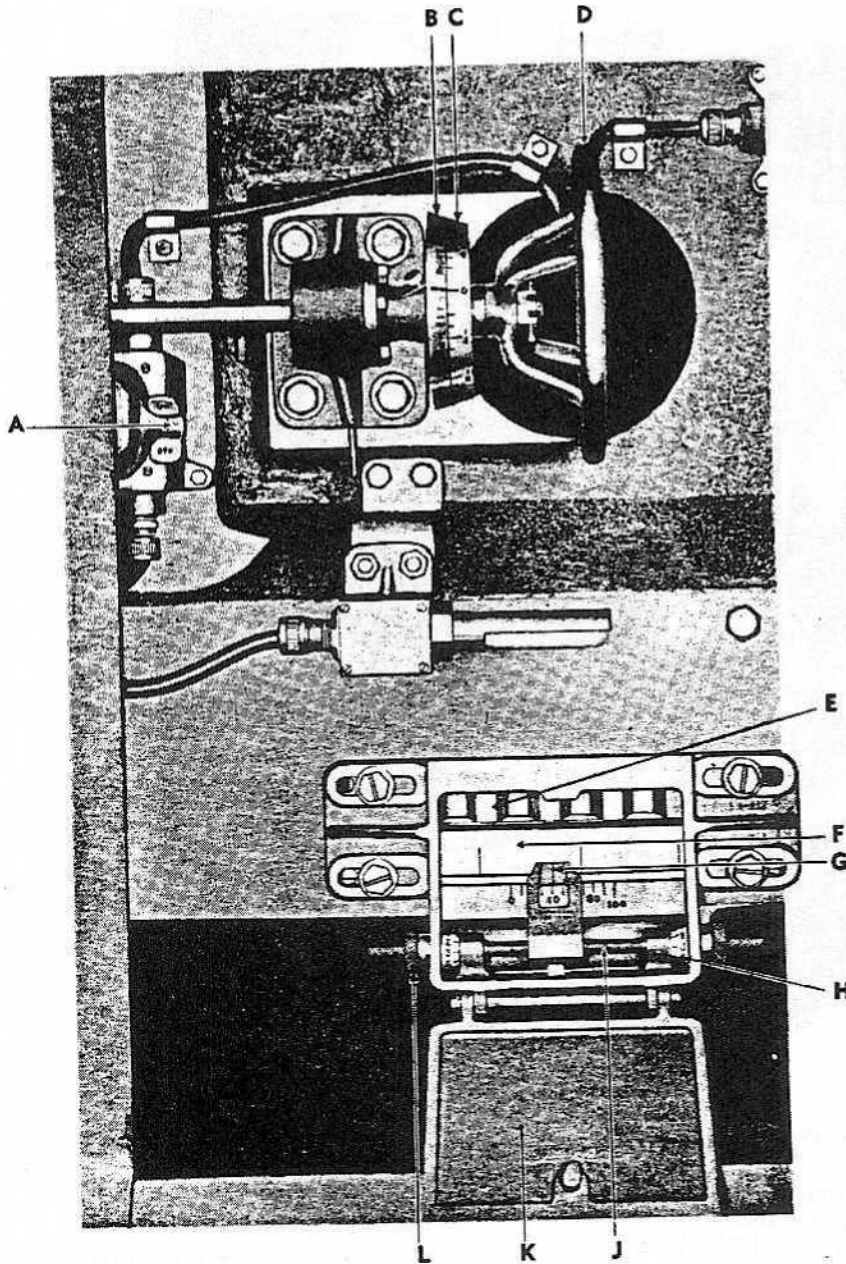

- |   |   |
|---|---|
| <p>A—AZIMUTH POINTER LIGHT SWITCH BOX A162527</p> <p>B—TRAVERSING CONTROL GEAR CASE C54826</p> <p>C—TRAVERSING CONTROL INDICATOR DIAL C54825</p> <p>D—TRAVERSING CONTROL HANDWHEEL C54823</p> <p>E—TRAVERSING RACK D49060</p> <p>F—AZIMUTH CIRCLE D42534</p> <p>G—AZIMUTH INDICATOR B162984</p> | <p>H—AZIMUTH VERNIER INDICATOR (RIGHT) B162983B</p> <p>J—AZIMUTH INDICATOR SHAFT SCREW B162985</p> <p>K—AZIMUTH INDICATOR BOX COVER C54851</p> <p>L—AZIMUTH VERNIER INDICATOR (LEFT) B162983A</p> |
|---|---|

RA PD 38792

Figure 103—Azimuth Indicator and Traversing Speed-gear Control

DESCRIPTION AND FUNCTIONING

- C — TRAVERSING BRACKET D42198
- D — OUTER DUST GUARD (RACER) B163196
- E — SCREW BCAX2BB
- F — 2 CONDUCTOR NO. 14 CABLE (F) STRANDED

- G — CLAMP A217813 AND SCREW BCAX1BA
- H — SCREW BCAX1EA
- J — TRAVERSING PINION GUARD C87056
- K — TRAVERSING BRACKET PLATE C54681
- L — SCREW BCAX1CD—NUT BBAX1C AND WASHER BECX1K
- M — LIMIT SWITCH C87140
- N — CONNECTOR B162514
- P — SCREW BCAX2BB
- Q — OPERATING LEVER
- R — CAM WHEEL
- S — SCREW BCAX1CD—NUT BBAX1C AND WASHER BECX1K
- T — BUSHING CPHX1AL
- U — COVER GASKET
- V — COVER SCREWS—WASHERS AND LOCKWASHERS
- W — COVER

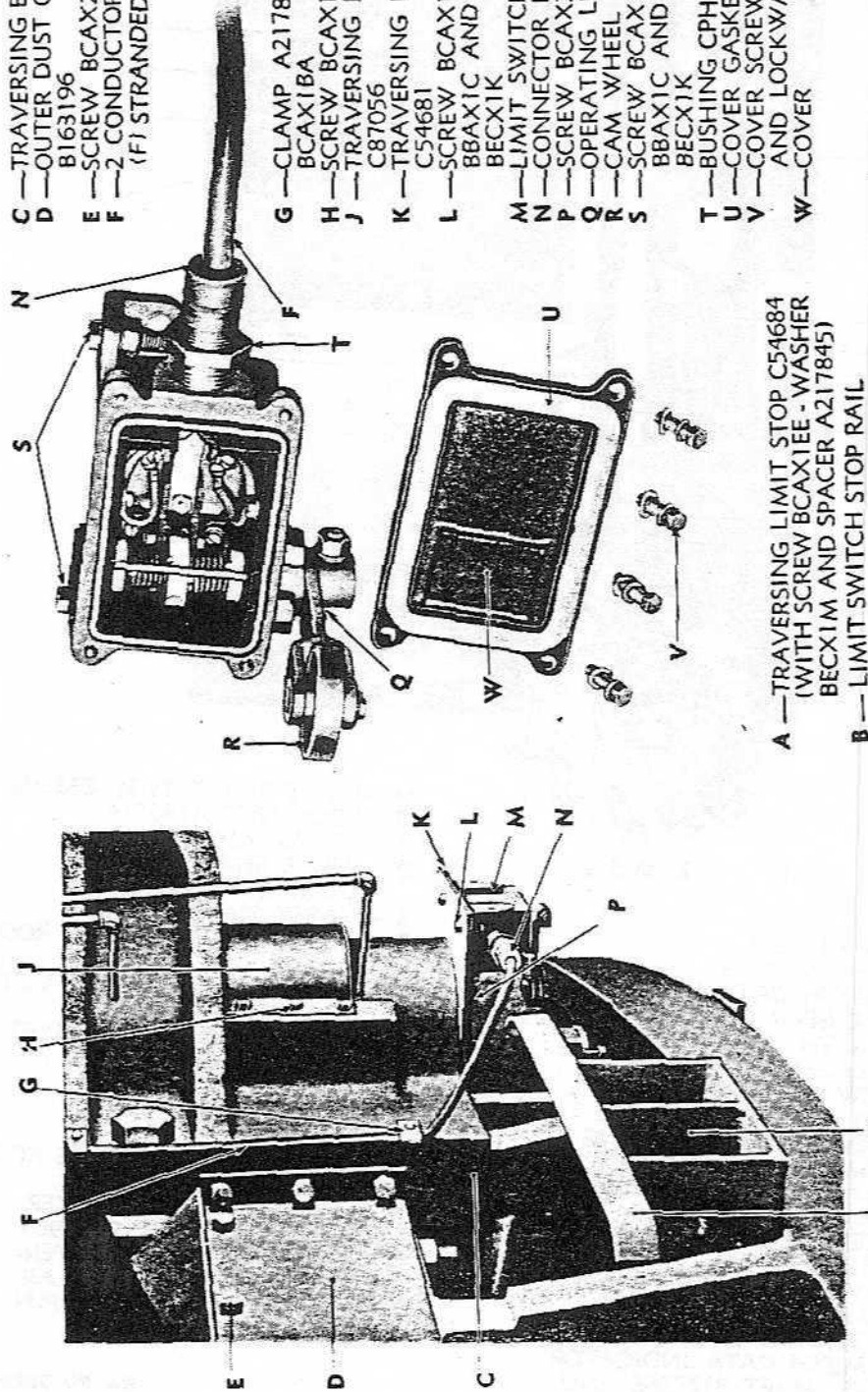

- A — TRAVERSING LIMIT STOP C54684 (WITH SCREW BCAX1EE - WASHER BECX1M AND SPACER A217845)
- B — LIMIT SWITCH STOP RAIL

RA PD 38793

Figure 104—Traversing Limit Switch and Stop Rail

16-INCH SEACOAST GUN MATERIEL  
GUN MK. II M1; BARBETTE CARRIAGE M4

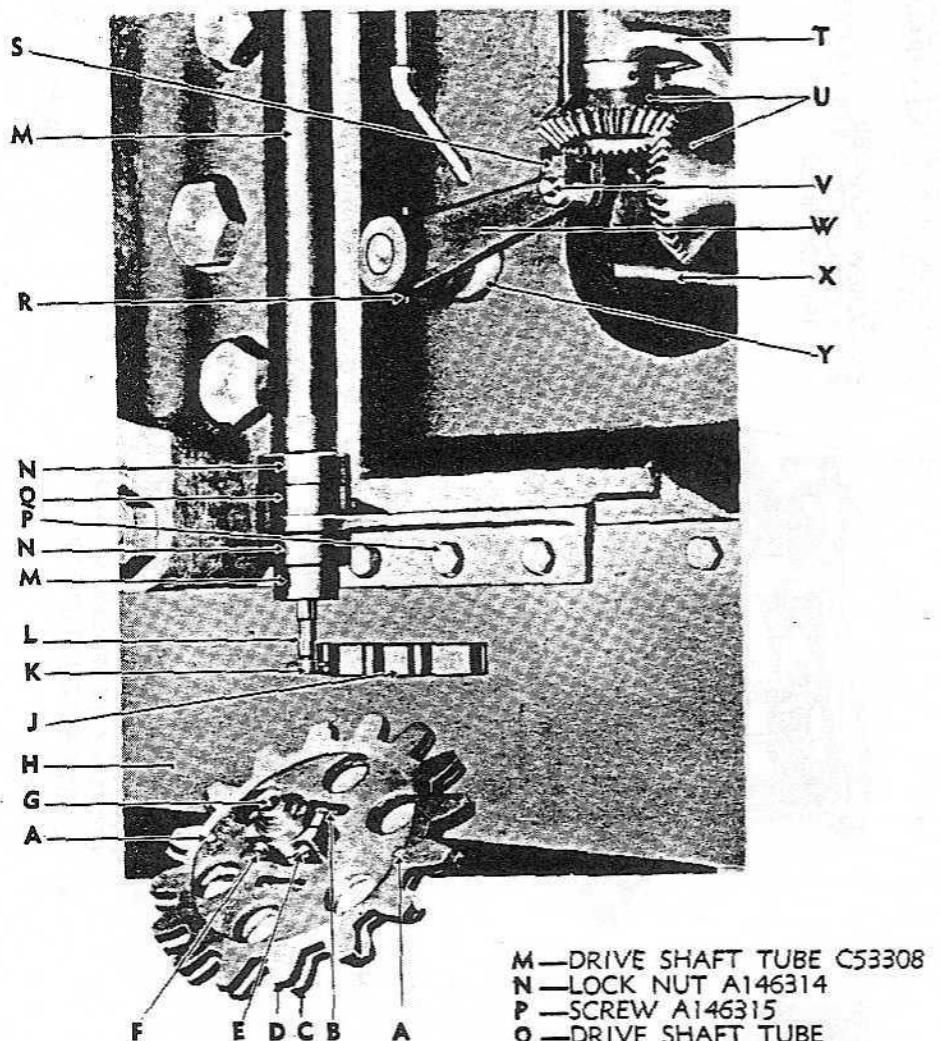

- A—STUD A146304
- B—SPRING A146303
- C—AZIMUTH DATA INDICATOR LOOSE GEAR C53306
- D—AZIMUTH DATA INDICATOR FIXED GEAR C53305
- E—SCREW BCCX1BC
- F—ZERO ADJUSTING DEVICE WORM A146261—BEARING A146262 AND PIN BFCX1R
- G—ZERO ADJUSTING DEVICE WORMWHEEL B127366
- H—RACER OUTER DUST GUARD B163195
- J—TRAVERSING RACK D49060
- K—COLLAR A146301 AND COTTER PIN BFAX1DG
- L—AZIMUTH DATA INDICATOR DRIVE SHAFT B127368 AND BALL BEARINGS A146279

- M—DRIVE SHAFT TUBE C53308
- N—LOCK NUT A146314
- P—SCREW A146315
- Q—DRIVE SHAFT TUBE BRACKET C54997
- R—TAPER PIN BFCX1GK
- S—CLUTCH CONNECTING ROD B162941
- T—VERTICAL CONTROL SHAFT BRACKET C54840
- U—LOWER INDICATOR SHAFT GEARS B162974 AND TAPER PIN BFCX1DK
- V—PIN BFEX2BG AND COTTER PIN BFAX1DF
- W—CLUTCH CONNECTING ROD LEVER B162942
- X—CLUTCH TREADLE INTERMEDIATE SHAFT B162969
- Y—CLUTCH TREADLE INTERMEDIATE SHAFT COLLAR A149681 AND TAPER PIN BFCX1DK

RA PD 38794

Figure 105—Azimuth Data Indicator Zero Adjusting Device

**DESCRIPTION AND FUNCTIONING****7. DESCRIPTION AND FUNCTIONING OF RAMMER.**

a. The mount is provided with a loading rammer. It is attached to the racer between the side frames at the rear of the gun breech. Either electric or hand power may be employed in its operation.

(1) **MOTOR OPERATION.** When operated by electric power the movement of the rammer is controlled by a hydraulic speed gear directly connected to and driven by an electric motor.

(2) **HAND OPERATION.** When operated by hand, the power is supplied by means of two cranks (P, fig. 109) located on the right and left sides of the rammer near the rear end.

(3) **PARKING TABLE.** A parking table (G, fig. 108) on either side of the rammer is provided to receive the projectiles and powder charges.

(4) **RAMMER CASE.** The rammer case (B, fig. 108) is provided with grooves on its inner sides which serve as a path for the rollers on the rammer chain.

(5) **RAMMER CHAIN.** The rammer chain (fig. 106) consists of a series of links connected by chain pins with rollers on each end which run freely in the grooves in the rammer case.

(6) **UNSTROKING DEVICE.** An unstroking device (P, fig. 110) prevents the rammer head from advancing beyond a predetermined distance in the gun. When this point is reached the device returns the control lever to neutral position (fig. 109), thereby stopping the forward motion of the rammer head. A zero adjusting coupling (L, fig. 110) provides adjustment of the unstroking position of the rammer head.

(7) **RAMMER HEAD.** A rammer head (D, fig. 107) and (fig. 111) provided with a hydraulic buffer is attached to the rammer chain. This buffer prevents excessive shock to the chain and rammer head when operated. The construction of the buffer provides for compression of two inches. It is returned to its normal position by means of buffer springs. Danger of injury to the rammer head and chain when it is withdrawn is minimized by means of this buffer action and by a system whereby the oil used in the operation of the motor speed gear is bypassed around the gear, rendering it inoperative.

(8) **CONTROL LEVER.**

(a) The movement of the rammer is controlled by means of a control lever (Q, fig. 109). Moving the lever upward to the position marked "RAM" (D, fig. 109) drives the projectile or powder charge forward, and a corresponding downward movement to the position marked "WITHDRAW" (N, fig. 109) returns the rammer head and pertaining parts to the starting position.

**16-INCH SEACOAST GUN MATERIEL  
GUN MK. II M1; BARBETTE CARRIAGE M4**

(b) The control lever is held in neutral position by a control lever detent assembly (M, fig. 109). Raising or lowering the control lever from the neutral position puts the speed gear (Q, fig. 110) into operation.

(9) **LOADING TROUGH.** A loading trough (fig. 106, and A and Q, fig. 107) on which the projectiles and powder charges are conveyed from the rammer to the gun is attached to the front end of the rammer.

(10) **INTERLOCKING DEVICE.** To prevent accidental forward movement of the ammunition before the loading trough is lowered to its proper position in the gun breech, an interlocking device (C, L and M, fig. 108) is provided. This arrangement prevents any upward movement of the control lever above neutral position (N, fig. 107) until the trough has been lowered to its seat in the gun breech.

(11) **LOADING ANGLE.** The correct loading angle for the gun is 3 degrees, 48 minutes elevation and this angle of elevation must be maintained without variation when the gun is being loaded. Failure to place the gun at this loading angle will result in undue strain upon the loading trough due to improper seating of the trough end in the gun breech (fig. 112). This position is determined by the loading position pointer (P, fig. 73).

(12) **AMMUNITION.** Projectiles are delivered to the rammer by means of ammunition trucks or by overhead trolley (fig. 113) (dummy projectile shown). Powder charges are conveyed by means of ammunition trucks only.

(13) **AMMUNITION TRUCKS.** Trucks for conveying ammunition are provided with aprons extending longitudinally along their sides. These aprons are hinged to the truck body and are utilized as bridges to insure safe transfer of the ammunition from the truck to the rammer trough.

(a) Safety dogs designed to prevent rolling of the ammunition during transit are provided on the truck bed. These dogs may be released by hand power, permitting the truck to be unloaded from either side.

(b) Bumpers assembled to the right and left side frames limit the forward movement of the truck.

(14) **SHOT TONGS.**

(a) When projectiles are transported by trolley they are brought from the magazine suspended in ammunition shot tongs (fig. 113) and delivered directly to the rammer trough. Chain falls (fig. 113) are employed for raising and lowering the projectiles.

(b) Description and functioning of ammunition trucks and shot tongs is outlined under "Tools and Accessories for the Carriage."

DESCRIPTION AND FUNCTIONING

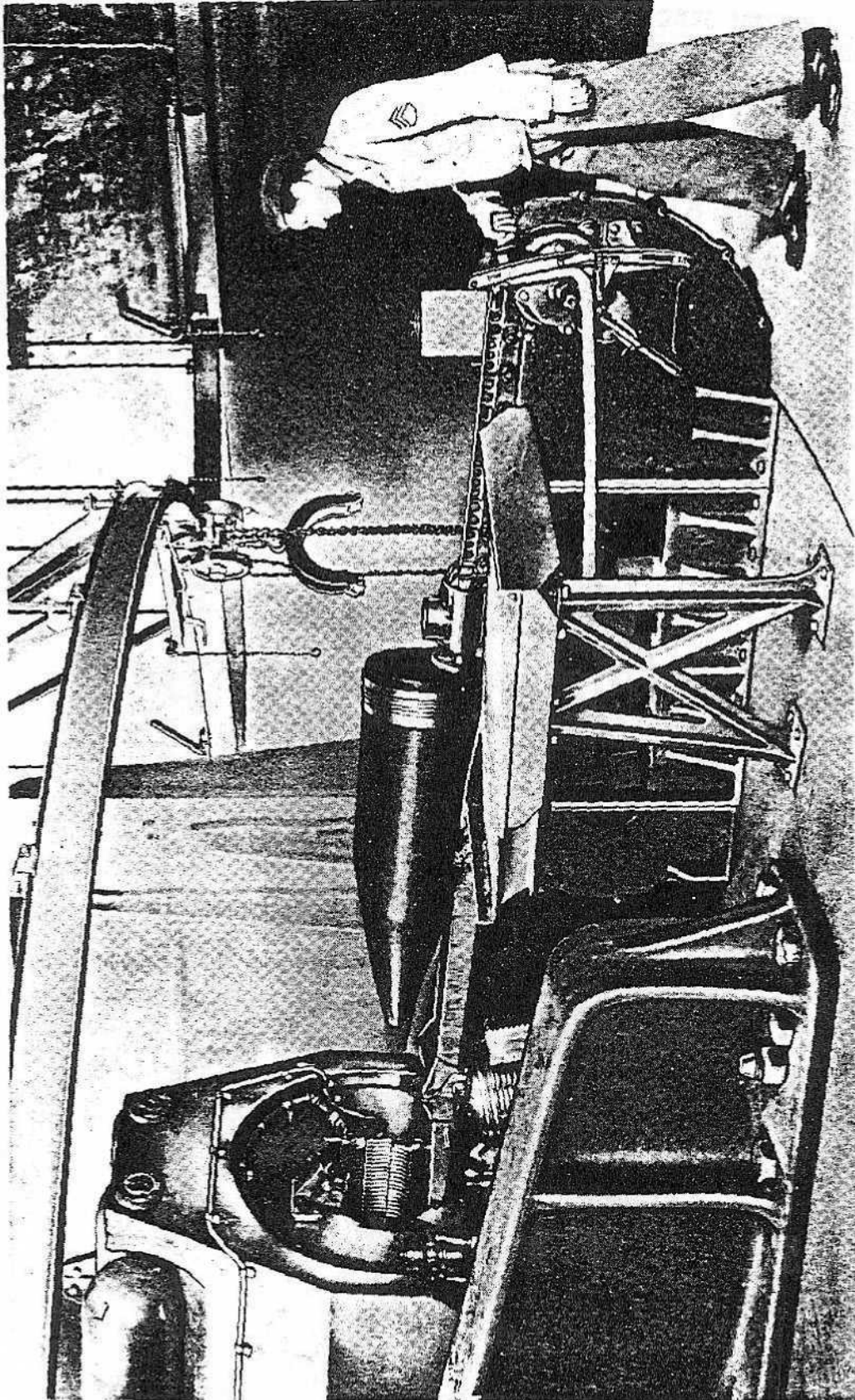

RA PD 38795

Figure 106—Loading by Power

**16-INCH SEACOAST GUN MATERIEL  
GUN MK. II M1; BARBETTE CARRIAGE M4**

- A—(REAR SECTION) LOADING TROUGH D41729
- B—LOADING TROUGH CHAIN AND SPROCKET (ASSEMBLY) D41737
- C—LOADING TROUGH SPRING BALANCE UNIT D41736
- D—RAMMER HEAD (ASSEMBLY) D42583
- E—RAMMER HEAD STOP PIN A149904 AND LOCK PLATE A149903
- F—OIL TANK COVER B162783 WITH BREATHER A217590
- G—OIL TANK C54994
- H—UNSTROKING DEVICE POWER TAKE OFF (ASSEMBLY) D46253
- J—CONTROL LEVER DETENT (ASSEMBLY) D46252
- K—RAMMER CHAIN SPROCKET AND CLUTCH (ASSEMBLY) D42591
- L—TOGGLE PIN (ASSEMBLY) B163186
- M—CLUTCH FORK AND ROLL (ASSEMBLY) B163152
- N—CONTROL INTERLOCK C53622
- P—RAMMER CASE AND SPEED GEAR CONTROL (ASSEMBLY) D42588
- Q—(FRONT SECTION) LOADING TROUGH D41702
- R—LOADING TROUGH HANDLE A147386

RA PD 38797

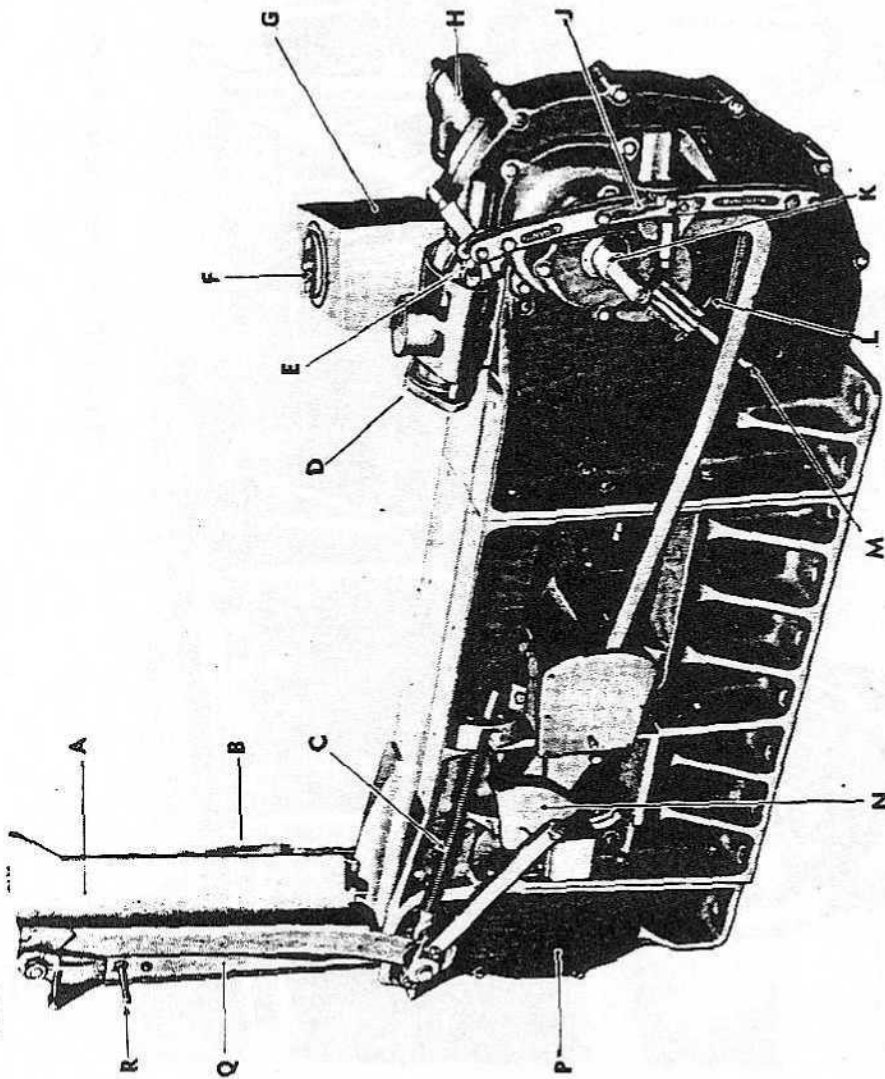
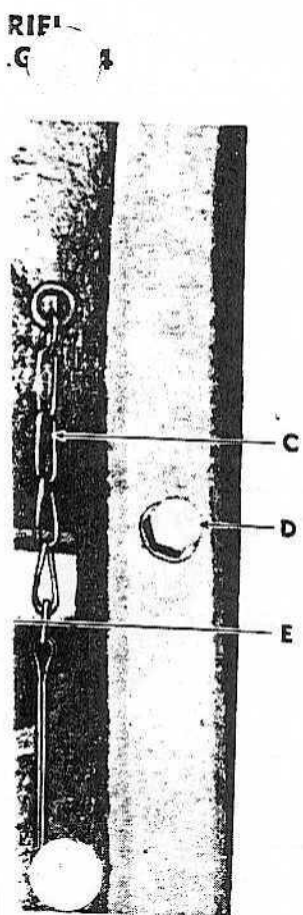

**Figure 107 — Rammer (Left Side) with Loading Trough in Folded Position  
(Parking Tables Removed)**

DESCRIPTION AND FUNCTIONING

- A—CRADLE E215
- B—EXPANSION CHAMBER (ASSEMBLY) B187386
- C—EXPANSION CHAMBER HANGER A218448 AND SCREW BCAX28D
- D—HANGER LINER A218449
- E—UNION A218455
- F—LONG PIPE C54678
- G—PIPE CLIP A218445—SCREW BCAX1EC AND LOCK WASHER BECX1M
- H—NIPPLE A218450
- J—TEE A218454
- K—CAP A218453
- L—SHORT PIPE A218451
- M—COUPLING A218446—PLUG A218452 AND WASHER A218456
- N—SOLID PIPE PLUG A218473
- P—RECOIL CYLINDER HEAD D49027
- Q—(THROTTLING ROD) CENTERING PLUGS A218176 AND WASHER A218180
- R—(CYLINDER HEAD) BOLTS A218228
- S—RECOIL CYLINDER D49028
- T—STRAP BOLT B187238 AND LOCKING SCREW A218088
- U—RECOIL CYLINDER STRAP (FRONT) C87214
- V—RECOIL CYLINDER STRAP (REAR) C87213

RA PD 38722



EW A10029A AND WASHER BECX1M  
'009  
'008

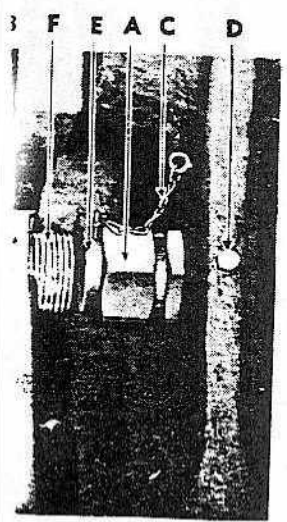

LOCKED POSITION  
RA PD 38721

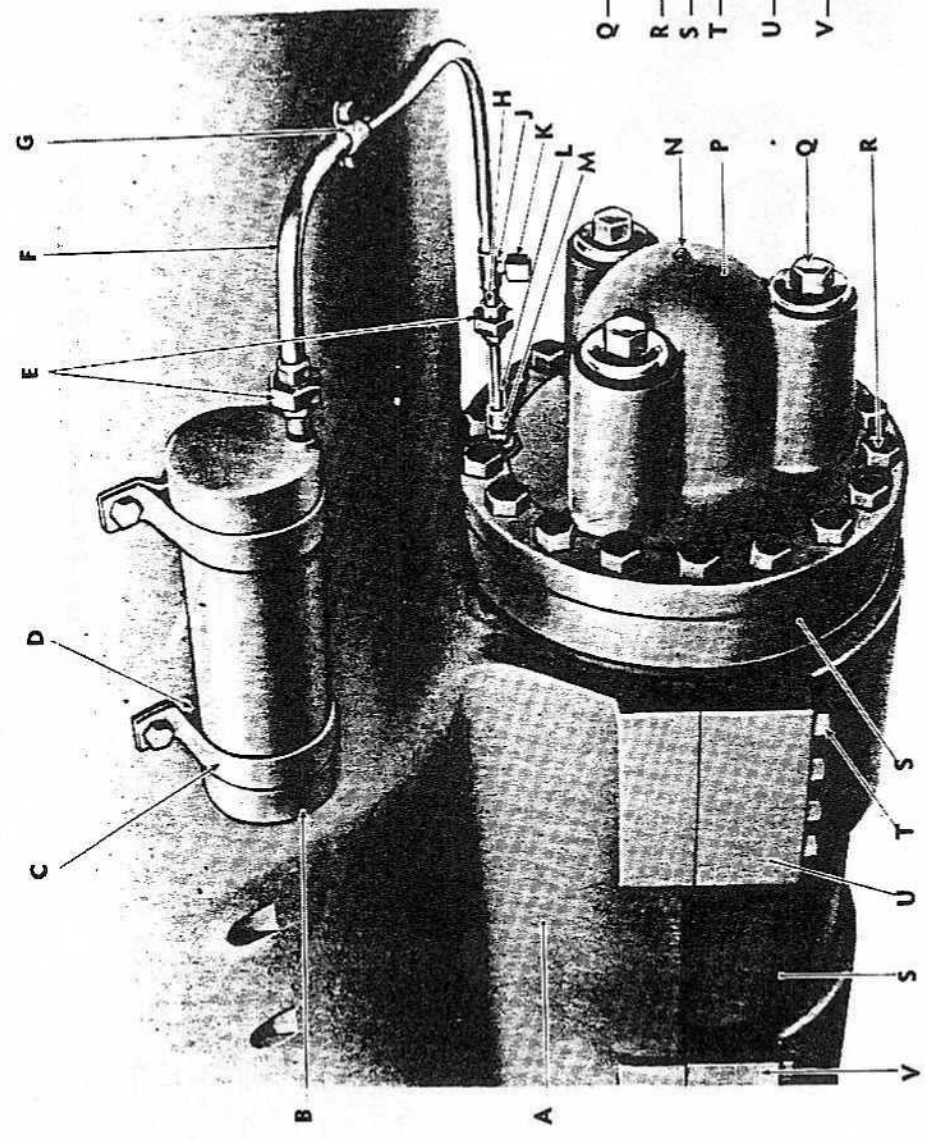
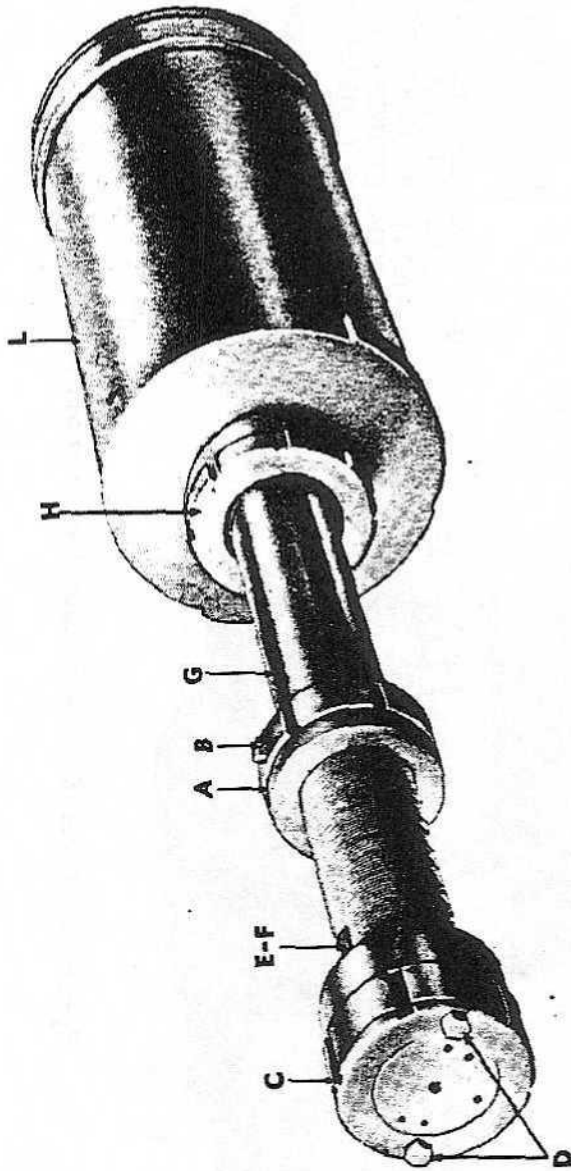

Figure 46—Recoil Cylinder Expansion Chamber and Tubing



16-INCH SEACOAST GUN MATERIEL  
GUN MK. II M1; BARBETTE CARRIAGE M4



- A — PISTON ROD FORWARD NUT B18727
- B — LOCK BOLT A218227
- C — PISTON ROD REAR NUT B187228
- D — REAR NUT LOCKING SCREW A218362
- E — PISTON ROD KEY SCREW A218363
- F — PISTON ROD KEY A218229
- G — PISTON AND PISTON ROD C87192
- H — PACKING GLAND NUT C87191
- J — STUFFING BOX PACKING GLAND B187231
- K — STUFFING BOX PACKING B187230
- L — RECOIL CYLINDER D49028 AND DOWEL PIN A218179
- M — CYLINDER HEAD DOWEL A218178
- N — GASKET B187222
- P — CYLINDER HEAD D49027
- Q — CENTERING PLUG A218176
- R — CENTERING PLUG WASHER A218180
- S — SOLID PIPE PLUG A218473
- T — (CYLINDER HEAD) BOLT A218228
- U — COUNTER RECOIL BUFFER PLUNGER D49029
- V — PLUNGER LOCK SCREW B187223
- W — SET SCREW A218236
- X — PISTON RING B187229
- Y — THROTTLING ROD D49040

RA PD 38724

Figure 47 — Recoil Cylinder (Assembled)

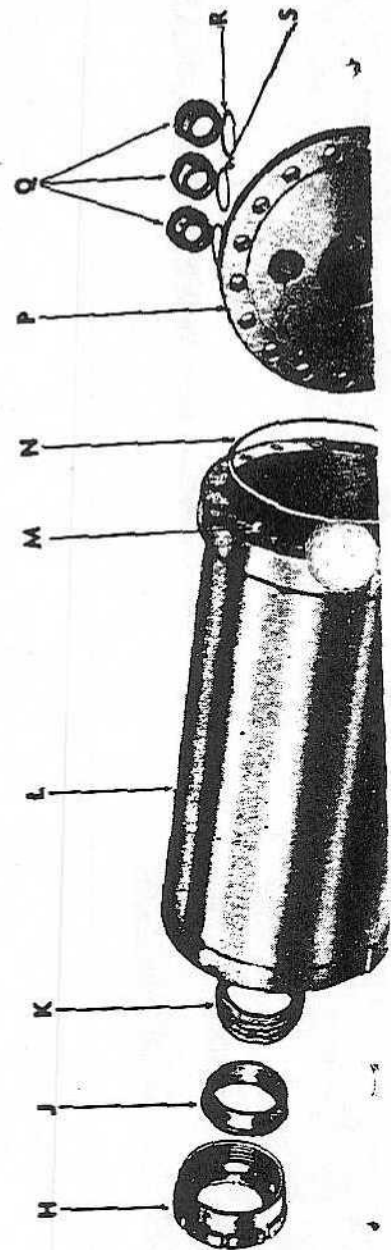

65

- D — REAR NUT LOCKING SCREW A218362
- E — PISTON ROD KEY A218363
- F — PISTON ROD KEY A218229
- G — PISTON AND PISTON ROD C87192
- H — PACKING GLAND NUT C87191
- L — RECOIL CYLINDER D49028 AND DOWEL PIN A218178
- M — CYLINDER HEAD FEL A218178
- N — GASKET B187222
- P — CYLINDER HEAD D49027
- Q — CENTERING PLUG A218176
- R — CENTERING PLUG WASHER A218180
- V — PLUNGER LOCK SCREW B187223
- W — SET SCREW A218236
- X — PISTON RING B187229
- Y — THROTTLING ROD D49040

Figure 47 — Recoil Cylinder (Assembled)

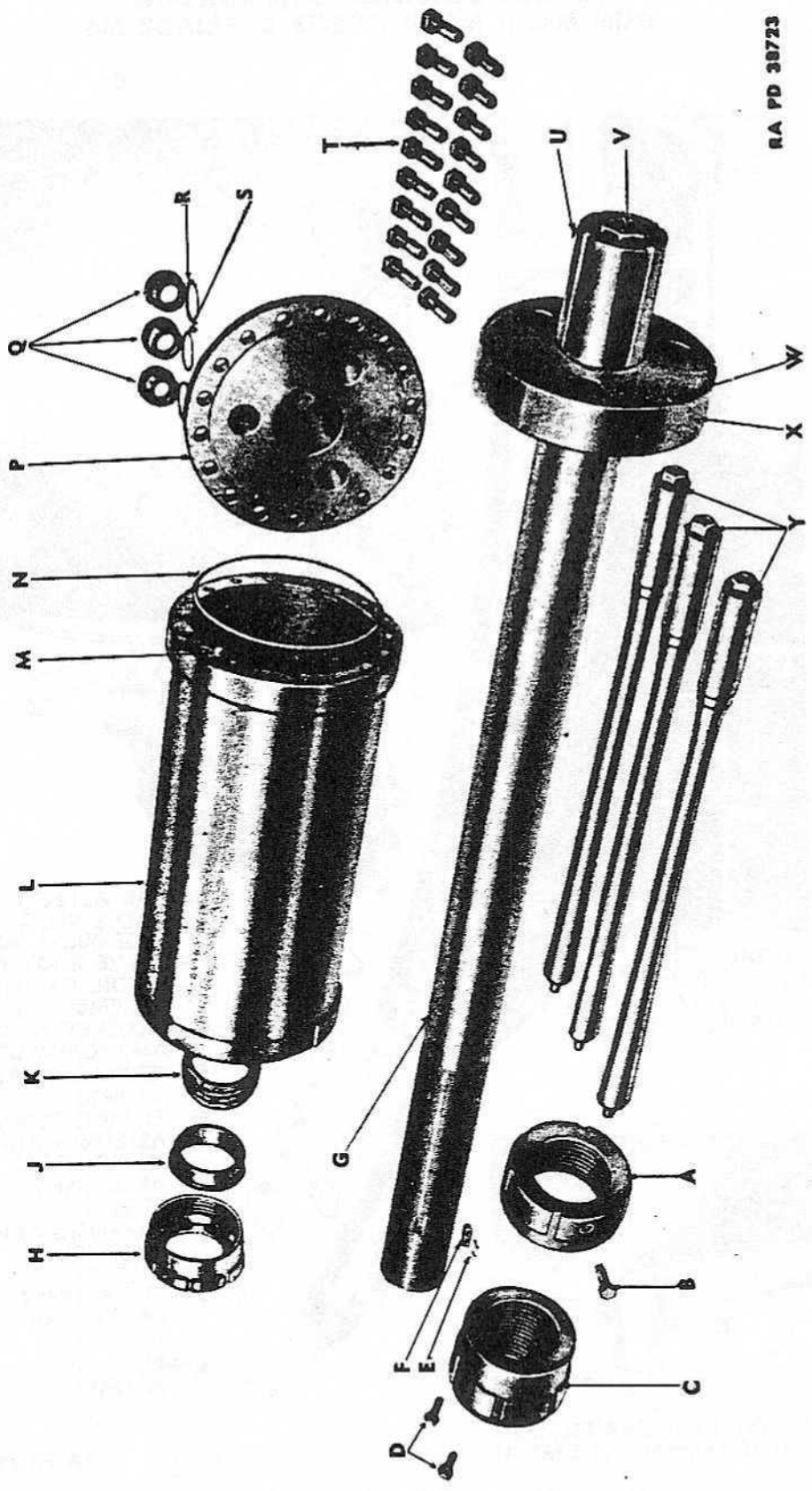

RA PD 38723

DESCRIPTION AND FUNCTIONING

TM 9-471  
6

Figure 47-1 — Recoil Cylinder — Exploded View  
(LEGEND ON OPPOSITE PAGE)

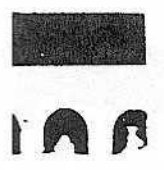

17	11	11	1	1
11	11	11	1	1

16-INCH SEACOAST GUN MATERIEL  
GUN MK. II M1; BARBETTE CARRIAGE M4

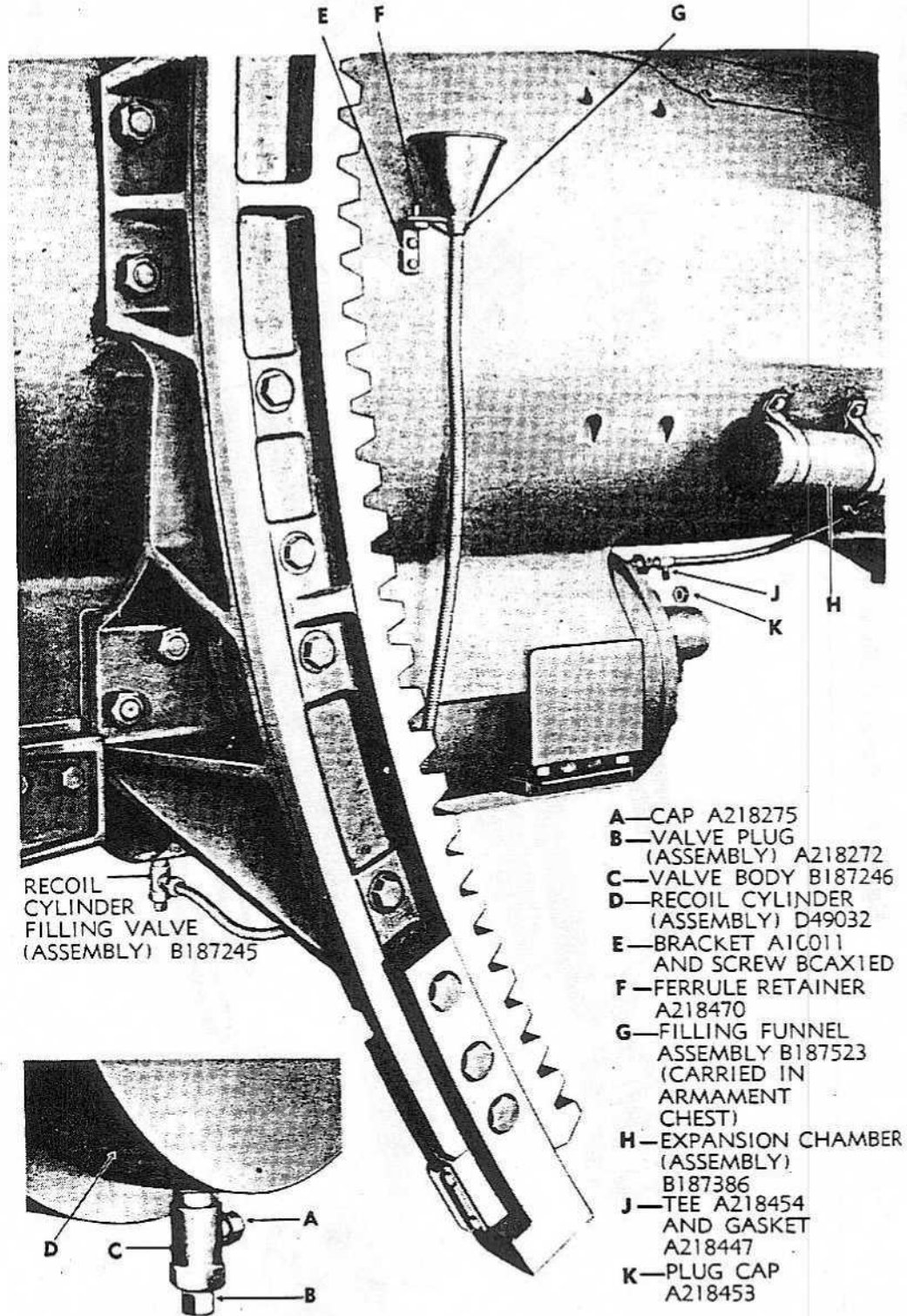

RECOIL CYLINDER FILLING VALVE (ASSEMBLY) B187245

- A—CAP A218275
- B—VALVE PLUG (ASSEMBLY) A218272
- C—VALVE BODY B187246
- D—RECOIL CYLINDER (ASSEMBLY) D49032
- E—BRACKET A1C011 AND SCREW BCAX1ED
- F—FERRULE RETAINER A218470
- G—FILLING FUNNEL ASSEMBLY B187523 (CARRIED IN ARMAMENT CHEST)
- H—EXPANSION CHAMBER (ASSEMBLY) B187386
- J—TEE A218454 AND GASKET A218447
- K—PLUG CAP A218453

RECOIL CYLINDER FILLING VALVE (ASSEMBLY) B187245

RA PD 38725

Figure 48—Recoil Cylinder Filling Device

DESCRIPTION AND FUNCTIONING

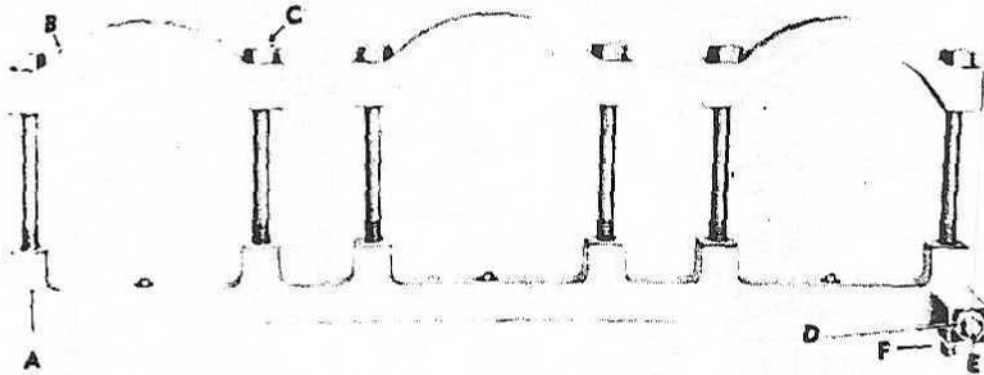
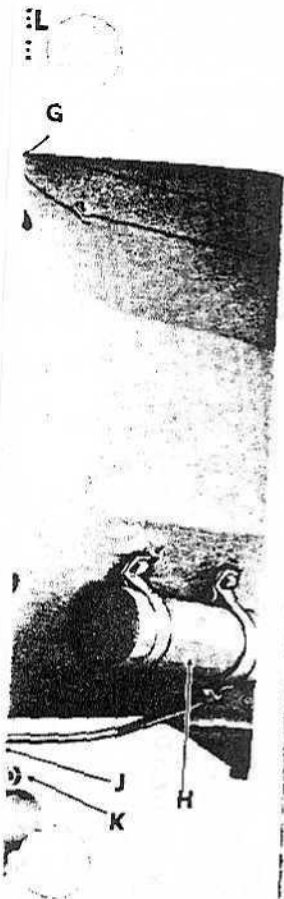

- A—AIR MANIFOLD (ASSEMBLY) D49074 USED FOR REPLACEMENTS)
- B—MANIFOLD STRAP B187209
- C—(MANIFOLD STRAP) BOLT B187205A
- D—VALVE PACKING GLAND A218358—PACKING A218360 AND PACKING RING A218359
- E—AIR MANIFOLD VALVE B187346
- F—BUSHING A218235

RA PD 38732

Figure 49—Recuperator Manifold

- P A218275
- LVE PLUG
- SEMBLY) A218272
- LVE BODY B187246
- COIL CYLINDER
- SEMBLY) D49032
- CKET A1C011
- D SCREW BCAXIED
- RULE RETAINER
- 8470
- LING FUNNEL
- SEMBLY B187523
- ARRIED IN
- AMENT
- EST)
- ANSION CHAMBER
- SEMBLY)
- 7386
- A218454
- GASKET
- 8447
- IG CAP
- 8453

D 38725

16-INCH SEACOAST GUN MATERIEL  
GUN MK. II M1; BARBETTE CARRIAGE M4

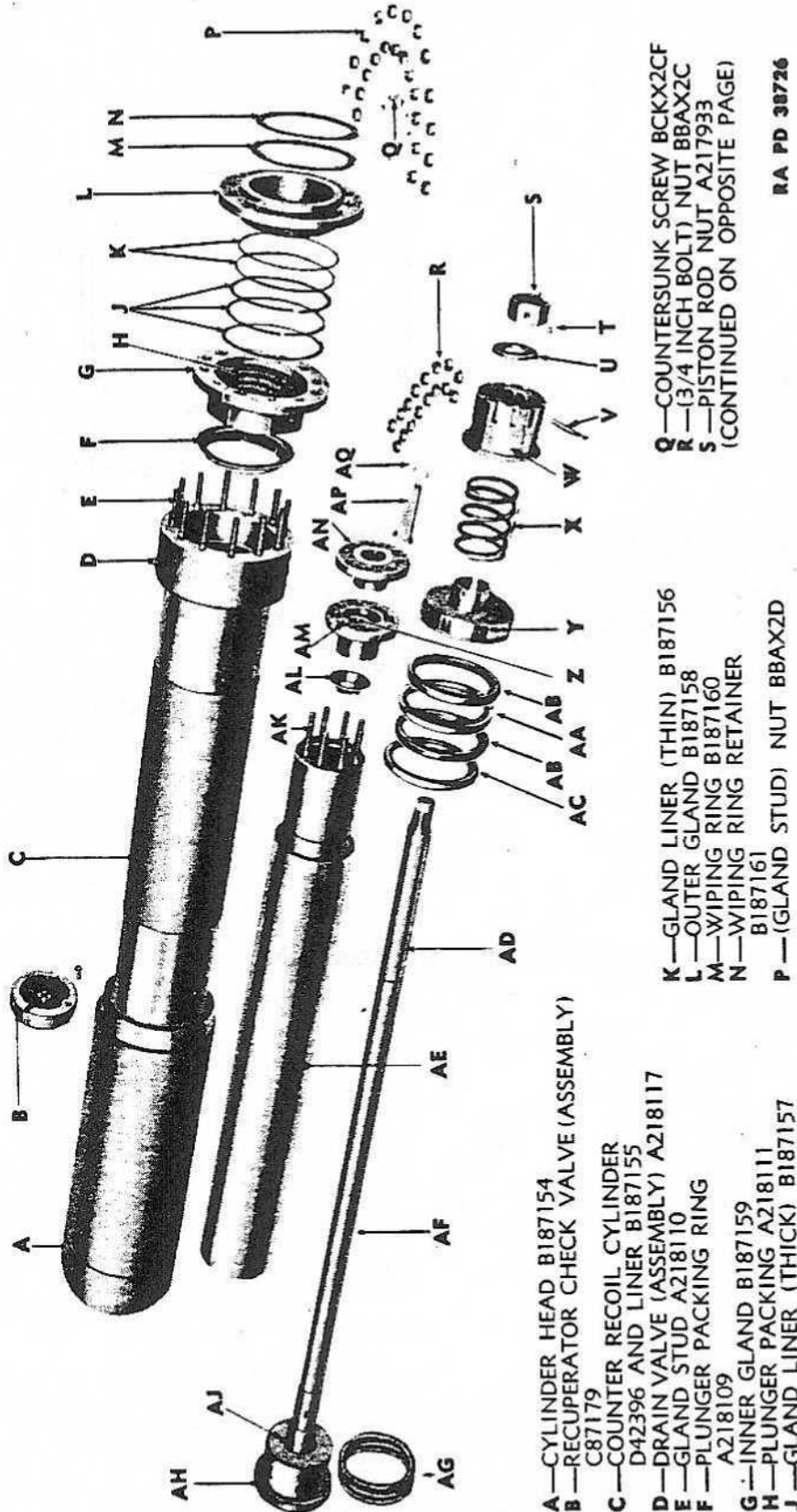

- A—CYLINDER HEAD B187154
- B—RECUPERATOR CHECK VALVE (ASSEMBLY) C87179
- C—COUNTER RECOIL CYLINDER D42396 AND LINER B187155
- D—DRAIN VALVE (ASSEMBLY) A218117
- E—GLAND STUD A218110
- F—PLUNGER PACKING RING A218109
- G—INNER GLAND B187159
- H—PLUNGER PACKING A218111
- J—GLAND LINER (THICK) B187157
- K—GLAND LINER (THIN) B187156
- L—OUTER GLAND B187158
- M—WIPING RING B187160
- N—WIPING RING RETAINER B187161
- P—(GLAND STUD) NUT BBAX2D
- Q—COUNTERSUNK SCREW BCKX2CF
- R—(3/4 INCH BOLT) NUT BBAX2C
- S—PISTON ROD NUT A217933 (CONTINUED ON OPPOSITE PAGE)

RA PD 38726

Figure 50—Recuperator Cylinder—Exploded View

- AE—PLUNGER C87180
- AF—PISTON ROD B162603
- AG—FLOATING PISTON PACKING A218113
- AH—FLOATING PISTON B162602
- AJ—CAP SCREW BCCX1CB
- AK—GLAND STUD A218106
- AL—PISTON ROD PACKING RING A2181
- AM—INNER GLAND B187157

- IA TO S LISTED ON PRECEDING PAGE)
- T—HEADLESS SET SCREW A218108
- U—PISTON ROD NUT WASHER A217932
- V—COTTER PIN A218101
- W—FLOATING PISTON PACKING RING NUT B162598

- Q—COUNTERSUNK SCREW BCKX2CF
- R—(3/4 INCH BOLT) NUT BBAX2C
- S—PISTON ROD NUT A217933  
(CONTINUED ON OPPOSITE PAGE)

RA PD 38726

- K—GLAND LINER (T B187156
- L—OUTER GLAND B 58
- M—WIPING RING B187160
- N—WIPING RING RETAINER B187161
- P—(GLAND STUD) NUT BBAX2D

- D—DRAIN VALVE (ASSEMBLY) A218117
- E—AND STUD A218110
- F—PISTON ROD NUT WASHER A217932
- G—INNER GLAND B187159
- H—PLUNGER PACKING A218111
- J—GLAND LINER (THICK) B187157

Figure 50—Recuperator Cylinder—Exploded View

DESCRIPTION AND FUNCTIONING

- AE—PLUNGER C87180
- AF—PISTON ROD B162603
- AG—FLOATING PISTON PACKING A218113
- AH—FLOATING PISTON B162602
- AJ—CAP SCREW BCCX1CB
- AK—GLAND STUD A218106
- AL—PISTON ROD PACKING RING A218107
- AM—INNER GLAND C87182
- AN—OUTER GLAND C87181
- AP—LIQUID INDICATOR B187153
- AQ—MACHINE SCREW BCGX1.BF
- AR—LIQUID VALVE ASSEMBLY C87139

- (A TO S LISTED ON PRECEDING PAGE)
- T—HEADLESS SET SCREW A218108
- U—PISTON ROD NUT WASHER A217932
- V—COTTER PIN A218101
- W—FLOATING PISTON PACKING SPRING NUT B162598
- X—FLOATING PISTON PACKING SPRING A147417
- Y—FLOATING PISTON PACKING DISK B162599
- Z—PISTON ROD PACKING A218105
- AA—PACKING RING (LONG) B162601
- AB—FLOATING PISTON PACKING RING A218114
- AC—PACKING RING (SHORT) B162600
- AD—PISTON ROD SLEEVE A217934 (FORCE FIT)

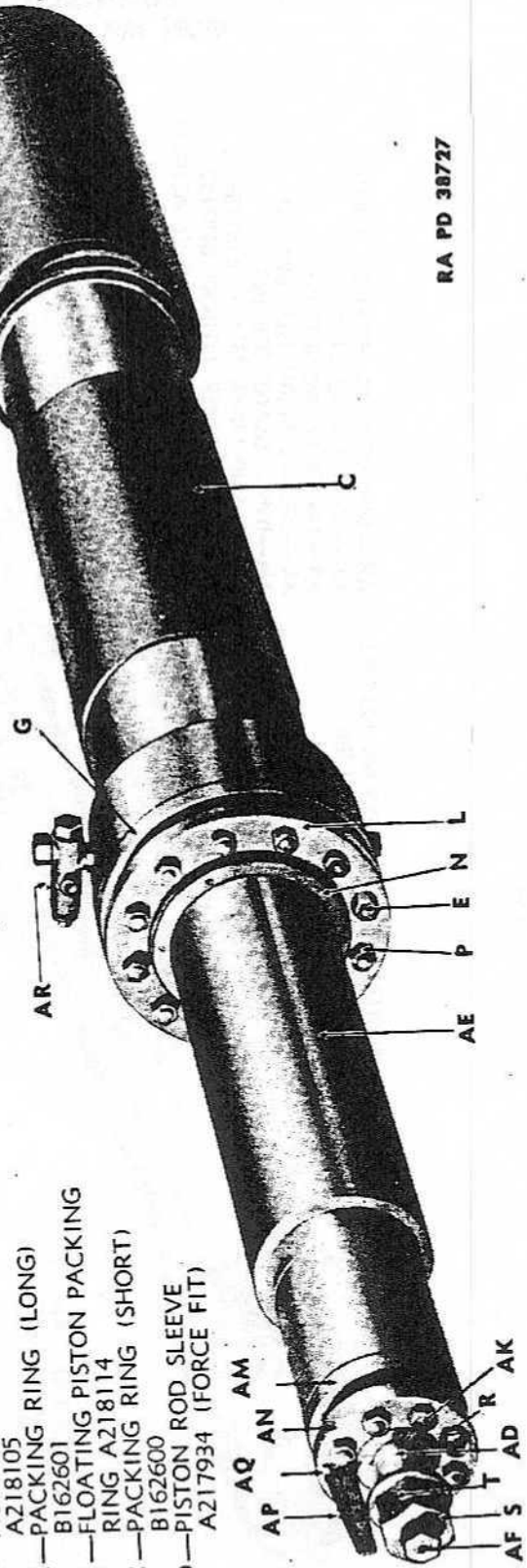

RA PD 38727

Figure 50-1—Recuperator Cylinder—Assembled View

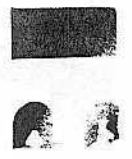

16-INCH SEACOAST GUN MATERIEL  
GUN MK. II M1; BARBETTE CARRIAGE M4

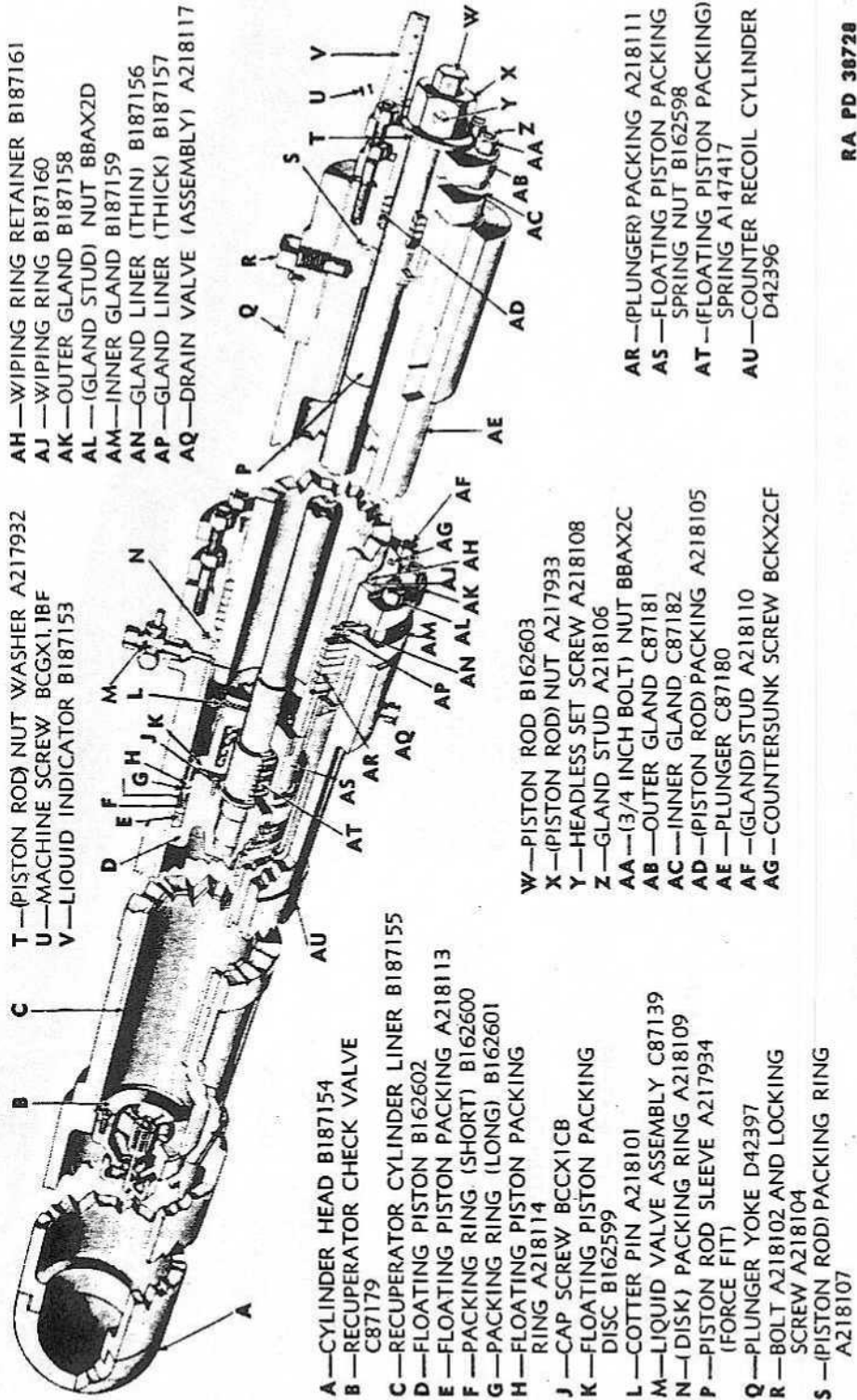

Figure 51—Recuperator Cylinder—Diagrammatic View

RA PD 38728

TEDIEL  
M4

DESCRIPTION AND FUNCTIONING

- AR—(PLUNGER) PACKING A218111
- AS—FLOATING PISTON PACKING SPRING NUT B162598
- AT—(FLOATING PISTON PACKING) SPRING A147417
- AU—COUNTER RECOIL CYLINDER D42396

RA PD 38728

- AA—13/16 INCH BOLT) NUT BBAX2C
- AB—OUTER GLA 87181
- AC—INNER GLA 37182
- AD—(PISTON ROD) PACKING A218105
- AE—PLUNGER C87180
- AF—(GLAND) STUD A218110
- AG—COUNTERSUNK SCREW BCKX2CF

- M—LIQUID VALVE ASSEMBLY C87139
- N—(DISK) PACKING RING A218109
- P—PISTON ROD SLEEVE A217934 (FORCE FIT)
- Q—PLUNGER YOKE D42397
- R—BOLT A218102 AND LOCKING SCREW A218104
- S—(PISTON ROD) PACKING RING A218107

Figure 51—Recuperator Cylinder—Diagrammatic View

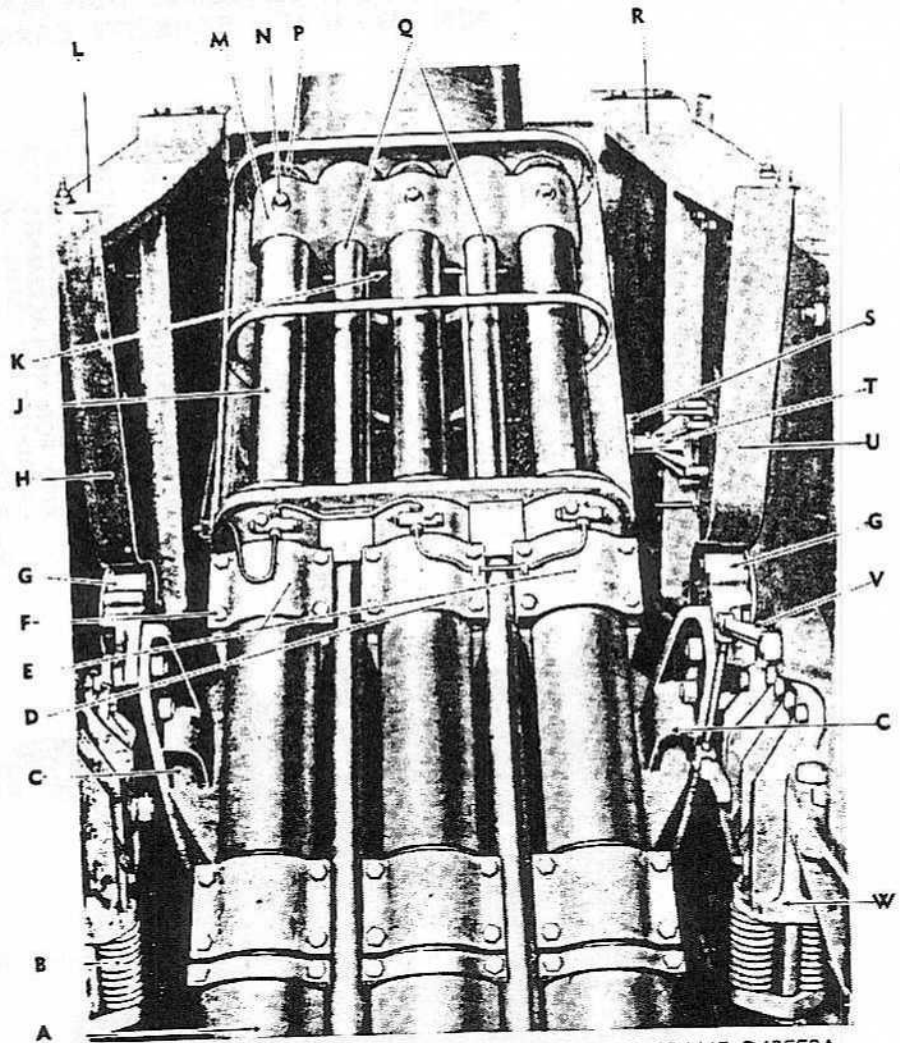

- A—RECUPERATOR CYLINDER (ASSEMBLY) D42398
- B—LEFT ELEVATING BUFFER (ASSEMBLY) D42144
- C—ELEVATING RACK AND BRACKET (ASSEMBLY) D42370 (FOR CARRIAGES NO. 29 AND UP AND REPLACEMENT FOR CARRIAGES NO. 19 TO 28 INCLUSIVE)
- D—CENTER RECUPERATOR CYLINDER STRAP C87188
- E—OUTER RECUPERATOR CYLINDER STRAP C87187
- F—BOLT B187205B AND LOCK SCREW A218104
- G—ELEVATING PINION SHAFT C54855
- H—LEFT ELEVATING RACK AND PINION GUARD C52770B AND SCREWS BCAX2BB
- J—RECUPERATOR PLUNGER C87180
- K—RECUPERATOR PLUNGER YOKE SHOE C87190—BOLT B187206 AND LOCK SCREW A218104
- L—LEFT SIDE FRAME D42550A
- M—RECUPERATOR PLUNGER YOKE D42397
- N—(PLUNGER) LOCKING BOLT A218102 AND SCREW A218104
- P—LIQUID INDICATOR B187153
- Q—RECUPERATOR PLUNGER YOKE ROD C87189—NUT B187207 AND LOCK SCREW A218234
- R—RIGHT SIDE FRAME D42549A
- S—ELEVATION INDICATOR DRIVE RACK D42314
- T—ELEVATION DATA INDICATOR DRIVE MECHANISM (ASSEMBLY) D41950
- U—RIGHT ELEVATION RACK AND PINION GUARD C52770A AND SCREWS BCAX2BB
- V—ELEVATING FOLLOW-UP CONTROL (ASSEMBLY) D42543
- W—RIGHT ELEVATING BUFFER (ASSEMBLY) D42145

RA PD 38729

Figure 52—Recuperator Plungers and Plunger Yoke—Exposed View (Dust Guard Removed)



16-INCH SEACOAST GUN MATERIEL  
GUN MK. II M1; BARBETTE CARRIAGE M4

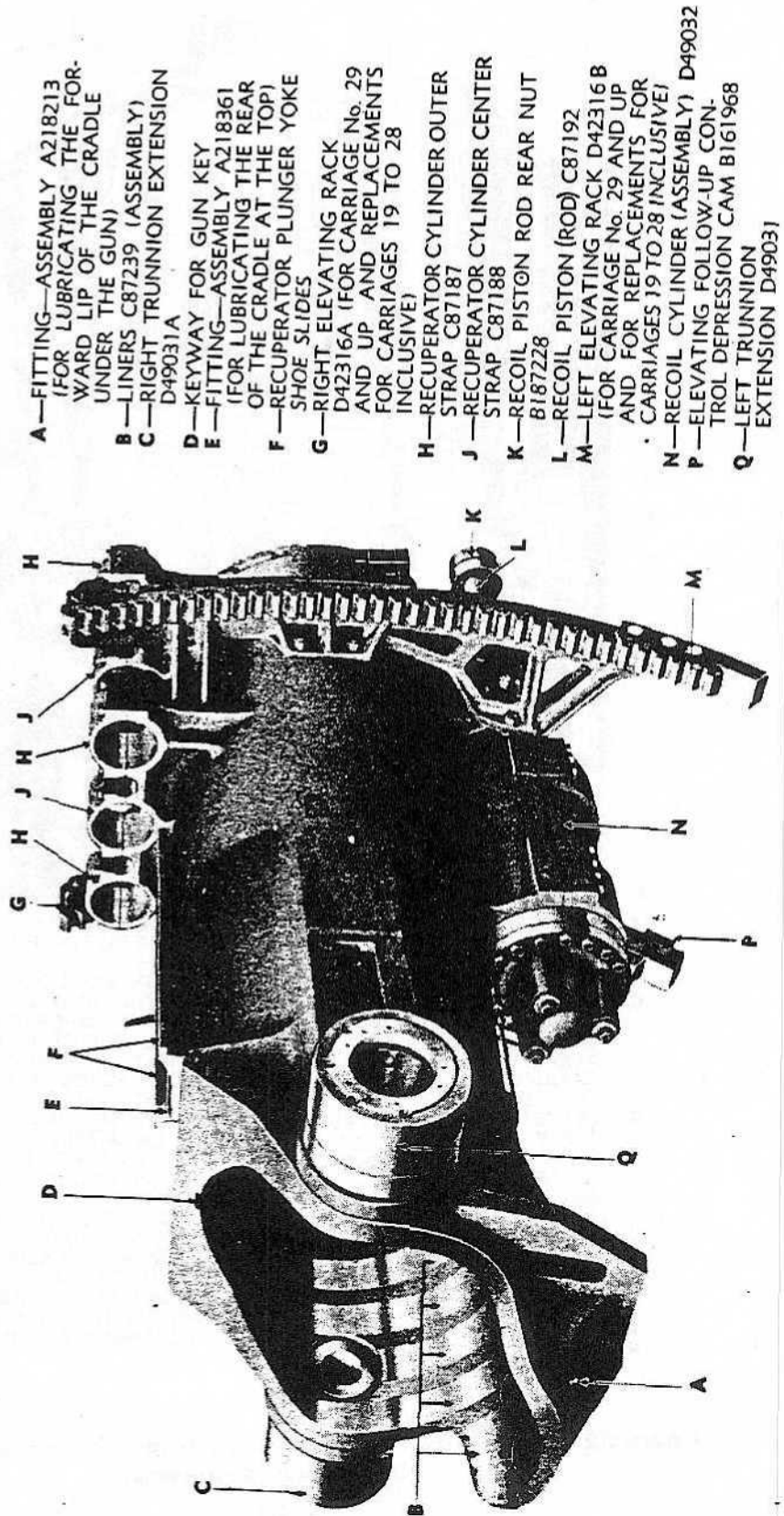

- A—FITTING—ASSEMBLY A218213 (FOR LUBRICATING THE FORWARD LIP OF THE CRADLE UNDER THE GUN)
- B—LINERS C87239 (ASSEMBLY)
- C—RIGHT TRUNNION EXTENSION D49031A
- D—KEYWAY FOR GUN KEY
- E—FITTING—ASSEMBLY A218361 (FOR LUBRICATING THE REAR OF THE CRADLE AT THE TOP)
- F—RECUPERATOR PLUNGER YOKE SHOE SLIDES
- G—RIGHT ELEVATING RACK D42316A (FOR CARRIAGE No. 29 AND UP AND REPLACEMENTS FOR CARRIAGES 19 TO 28 INCLUSIVE)
- H—RECUPERATOR CYLINDER OUTER STRAP C87187
- J—RECUPERATOR CYLINDER CENTER STRAP C87188
- K—RECOIL PISTON ROD REAR NUT B187228
- L—RECOIL PISTON (ROD) C87192
- M—LEFT ELEVATING RACK D42316B (FOR CARRIAGE No. 29 AND UP AND FOR REPLACEMENTS FOR CARRIAGES 19 TO 28 INCLUSIVE)
- N—RECOIL CYLINDER (ASSEMBLY) D49032
- P—ELEVATING FOLLOW-UP CONTROL DEPRESSION CAM B161968
- Q—LEFT TRUNNION EXTENSION D49031

RA PD 38731

Figure 53—Cradle with Elevating Racks—Front Left View  
(Recuperators Removed)

**Figure 53—Cradle with Elevating Racks—Front Left View  
(Recuperators Removed)**

- A—TUBING (ASSEMBLY) B187288
- B—VALVE BODY GLAND A218091
- C—RECUPERATOR CYLINDER D42396
- D—GRAVITY FILLING VALVE (ASSEMBLY) A218116
- E—GRAVITY FILLING INLET CAP A218092 AND GASKET A218093
- F—NUT A218103 AND PIPE COLLAR A218119
- G—LIQUID VALVE BODY (ASSEMBLY) B162597 AND GASKET A218090
- H—PRESSURE FILLING VALVE PACKING GLAND A218099—PACKING A218100 AND FOLLOWER A218096
- J—PRESSURE FILLING VALVE (ASSEMBLY) A218115
- K—TUBING (ASSEMBLY) B162370

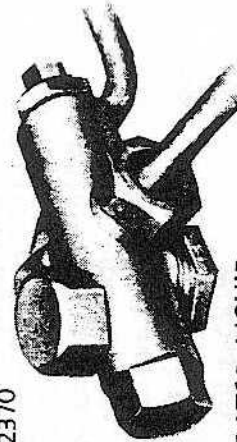

RECUPERATOR LIQUID VALVE (ASSEMBLY) C87139

**DESCRIPTION AND FUNCTIONING**

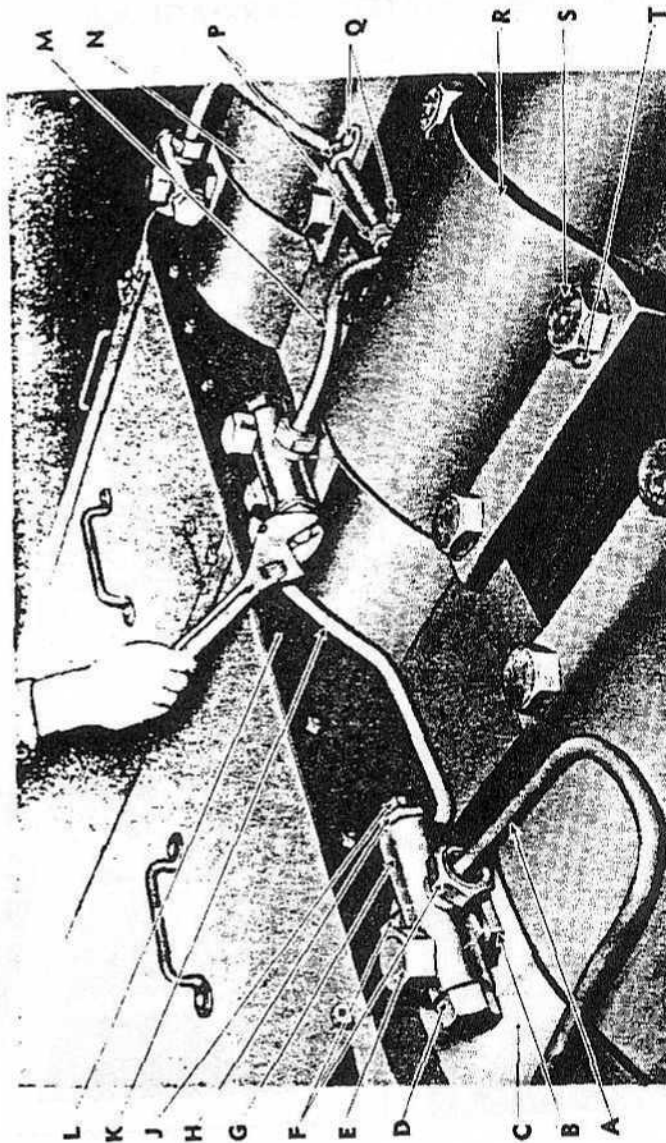

- L—PLUNGER COVER (ASSEMBLY) D42638
- M—TUBING (ASSEMBLY) B187172
- N—RECUPERATOR CYLINDER OUTER STRAP C87187
- P—PIPE CLIP A218121
- Q—SCREW BCAXICA AND LOCK WASHER BECX1K
- R—RECUPERATOR CYLINDER CENTER STRAP C87188
- S—BOLT B187205B
- T—LOCK SCREW A218104

**Figure 54—Operating Pressure Filling Valve**

16-INCH SEACOAST GUN MATERIEL  
GUN MK. II M1; BARBETTE CARRIAGE M4

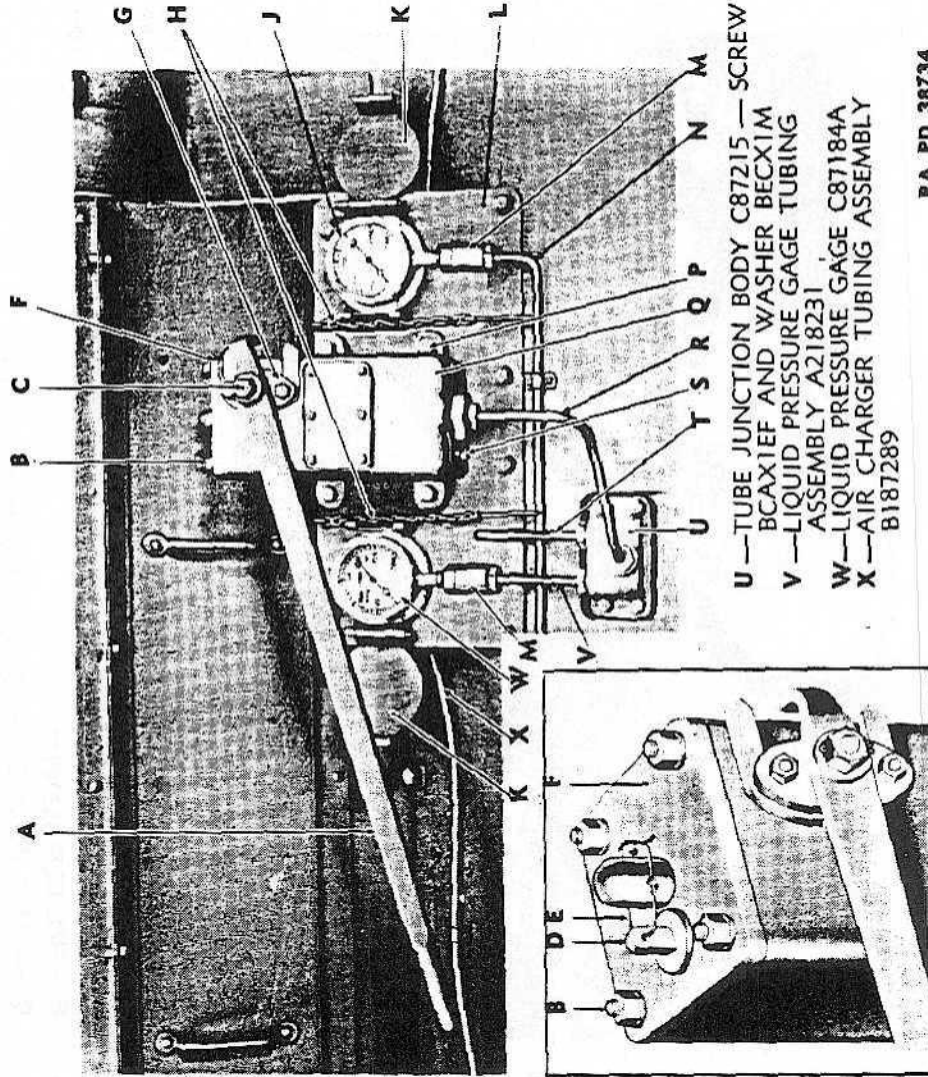

- A—PUMP LEVER C87145
- B—STUD A218059—NUT BBAX1E, AND WASHER BECXIM
- C—LEVER SHAFT NUT A218051 AND PIN BFAX1DK
- D—FILLING CAP B187204
- E—FILLING CAP LOOP A218071
- F—PUMP CASE COVER B187131
- G—LEVER SHAFT PACKING GLAND A218074 — COLLAR A218050 — PACKING A218066 AND SCREW BCAX1EE
- H—PRESSURE GAGE COVER FASTENER PIN ASSEMBLY B187162
- J—AIR PRESSURE GAGE C87184B
- K—PRESSURE GAGE COVER C87186 — HINGE B187163 — HINGE PIN A218041 AND COTTER PIN BFAX1CC
- L—GAGE BRACKET C87185 — SCREW BCAX1EC AND WASHER BECXIM
- M—PRESSURE GAGE CONNECTION B187165
- N—AIR PRESSURE GAGE TUBING ASSEMBLY B187290
- P—SCREW BCAX2AD—NUT BBAX2B AND WASHER BECXIP
- Q—PUMP CASE D42391
- R—LIQUID PUMP TUBING ASSEMBLY A218233
- S—DRAIN PLUG A218073
- T—RECUPERATOR CYLINDER LIQUID VALVE TUBING ASSEMBLY B187288

- U—TUBE JUNCTION BODY C87215 — SCREW BCAX1EF AND WASHER BECXIM
- V—LIQUID PRESSURE GAGE TUBING ASSEMBLY A218231
- W—LIQUID PRESSURE GAGE C87184A
- X—AIR CHARGER TUBING ASSEMBLY B187289

RA PD 38734

Figure 55—Liquid Pump and Pressure Gages

- A—FIRING CIRCUIT PLUG RECEPTACLE HOUSING B128000 AND CONDULET B127998
- B—(TRUNNION EXTENSION) TAP BOLT B634
- C—(TRUNNION ANTI-FRICTION) ROLLER BEARING B187295



REF

11 M



- S DRAIN PLUG A218073
- RECUPERATOR CYLINDER LIQUID VALVE TUBING ASSEMBLY B187288

- U—TUBE JUNCTION BODY C87215—SCREW BCAX1EF AND WASHER BCX1M
- V—LIQUID PRESSURE GAGE TUBING ASSEMBLY A218231
- W—LIQUID PRESSURE GAGE C87184A
- X—AIR CHARGER TUBING ASSEMBLY B187289

RA PD 38734

Figure 55—Liquid Pump and Pressure Gages

### DESCRIPTION AND FUNCTIONING

- A—FIRING CIRCUIT PLUG RECEPTACLE HOUSING B128000 AND CONDULET B127998
- B—(TRUNNION EXTENSION) TAP BOLT B634
- C—(TRUNNION ANTI-FRICTION) ROLLER BEARING B187295
- D—LEFT TRUNNION EXTENSION D49031
- E—(TRUNNION ROLLER) BEARING PIN C87218
- F—(TRUNNION BEARING PIN) SCREW BCAX2DG
- G—OPENING FOR ALEMITE FITTING
- H—(AIR-CHARGING AND MANEUVERING) VALVE BODY D26643
- J—(AIR-CHARGING AND MANEUVERING) VALVE STEM A146370
- K—(VALVE STEM PACKING) GLAND FOLLOWER A218366
- L—AIR INLET PLUG (ASSEMBLY) B187345
- M—AIR CHARGER TUBING (ASSEMBLY) B187289
- N—SCREW BCAX3A
- P—(DOUBLE TUBE) CLIP A146236
- Q—(MANEUVERING VALVE) SCREW BCAX1EF AND WASHER BCX1M
- R—(SINGLE TUBE) CLIP A218193
- S—AIR PRESSURE GAGE TUBING (ASSEMBLY) B187290

TM 9-471  
6

RA PD 38735

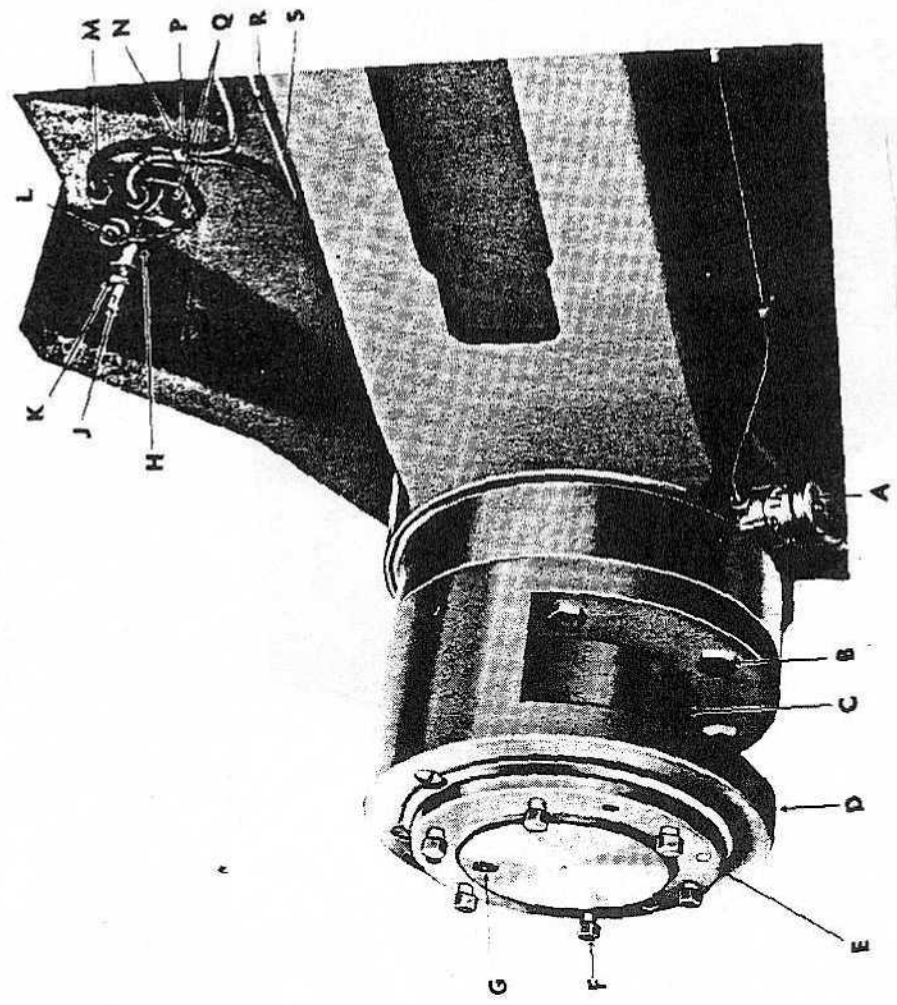

Figure 56—Air-charging and Maneuvering Valve and Trunnion Antifriction Roller Bearing on Cradle

16-INCH SEACOAST GUN MATERIEL  
GUN MK. II M1; BARBETTE CARRIAGE M4

RA PD 38736

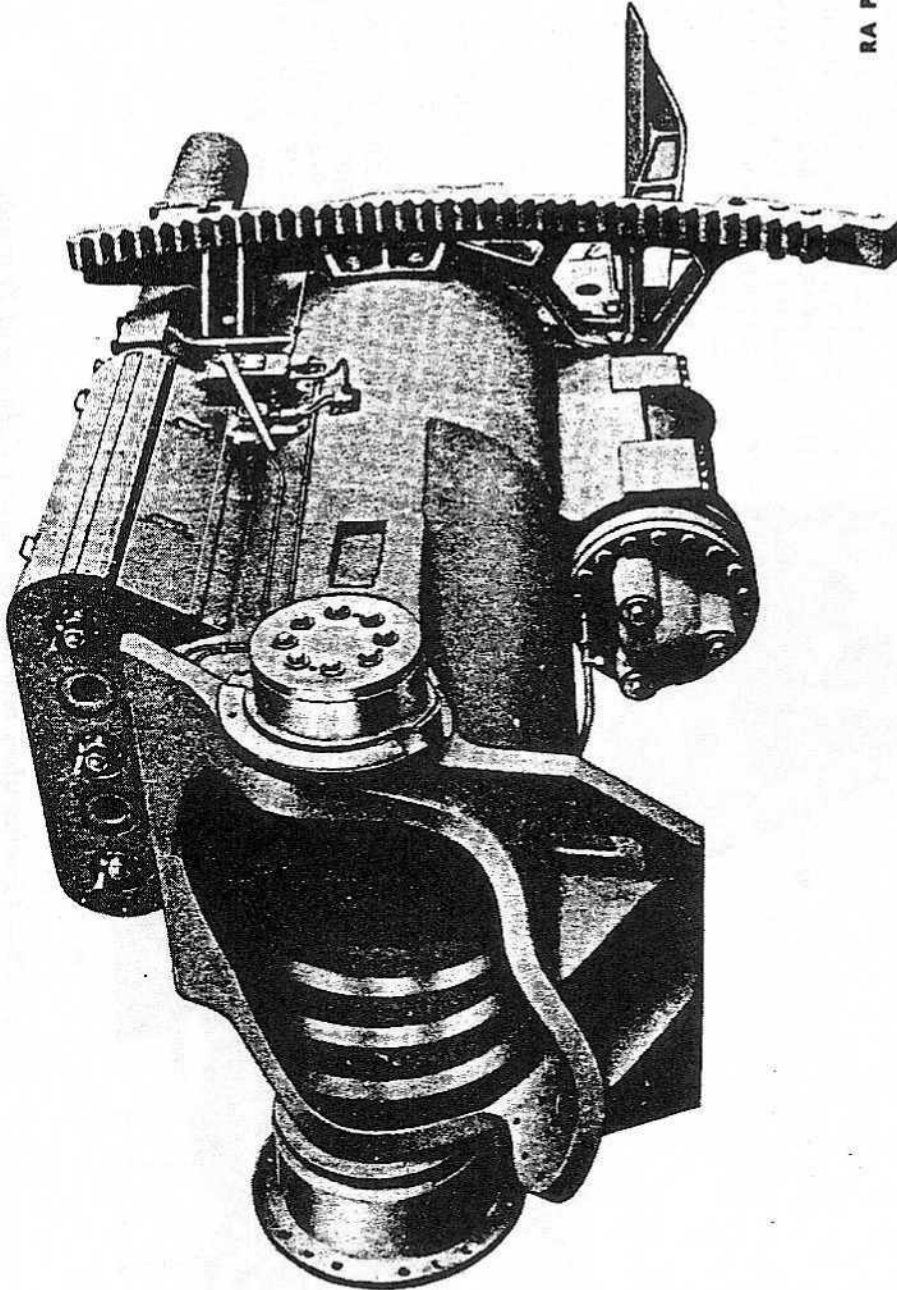

Figure 57 —Cradle Modified for Trunnion Roller Bearing

- A — MOISTURE TRAP DRAIN COCK
- B — CONTROL SYSTEM MOISTURE TRAP
- C — CONTROL SYSTEM AIR FILTER
- D — PIPE LEADING TO MAIN AIR PIPE
- E — COMPRESSOR MOTOR
- F — LOW PRESSURE STAGE CYLINDERS INTAKE AIR FILTERS
- G — LOW PRESSURE STAGE CYLINDER INTAKE VALVE COVER

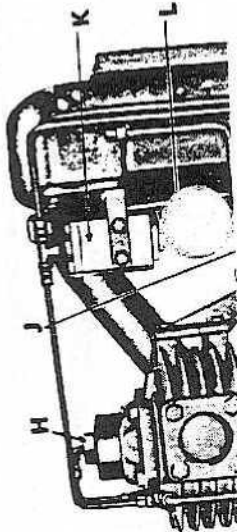
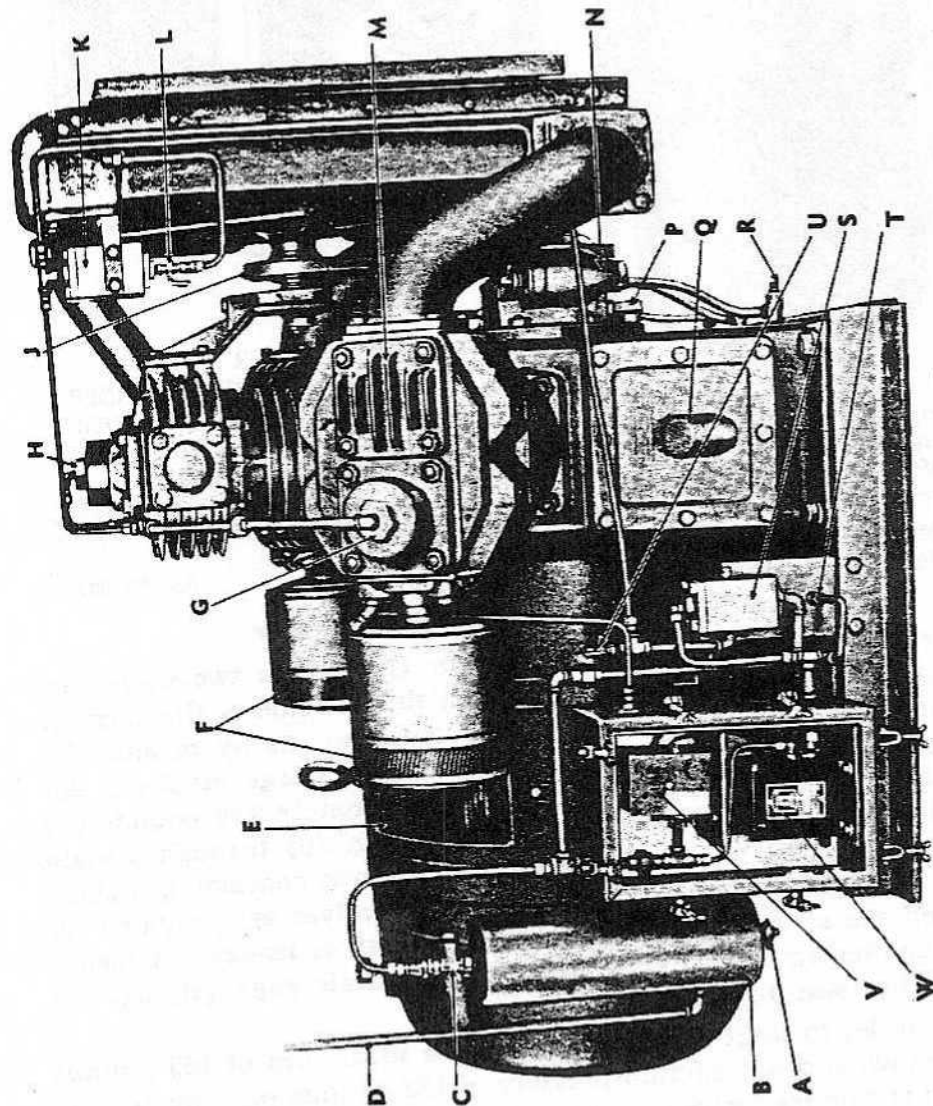

Figure 57—Cradle Modified for Trunnion Roller Bearing



- A—MOISTURE TRAP DRAIN COCK
- B—CONTROL SYSTEM MOISTURE TRAP
- C—CONTROL SYSTEM AIR FILTER
- D—PIPE LEADING TO MAIN AIR PIPE
- E—COMPRESSOR MOTOR
- F—LOW PRESSURE STAGE CYLINDERS
- G—INTAKE AIR FILTERS
- H—LOW PRESSURE STAGE CYLINDER INTAKE VALVE COVER
- I—HIGH PRESSURE STAGE CYLINDER INTAKE VALVE COVER
- J—INTERSTAGE COOLER FAN AND BELT
- K—UNLOADING SYSTEM UPPER RELAY VALVE
- L—INTERSTAGE COOLER VENT COCK
- M—LOW PRESSURE STAGE CYLINDER DISCHARGE VALVE COVER
- N—OIL FILTER HOUSING AND DRAIN PLUG
- P—OIL PUMP PRESSURE ADJUSTMENT DUST CAP
- Q—CRANK CASE OIL CAP
- R—CRANK CASE DRAIN PLUG
- S—UNLOADING SYSTEM LOWER RELAY VALVE
- T—UNLOADING SYSTEM AIR RESERVOIR PIPE
- U—UNLOADING SYSTEM PRIMING COCK
- V—AUTOMATIC PRESSURE SWITCH
- W—MAGNETIC UNLOADER

DESCRIPTION AND FUNCTIONING

TM 9-471  
6

RA PD 38737

Figure 58—Compressor and Motor Unit (Carriages 19, 20, 21 and 22)

16-INCH SEACOAST GUN MATERIEL  
GUN MK. II M1; BARBETTE CARRIAGE M4

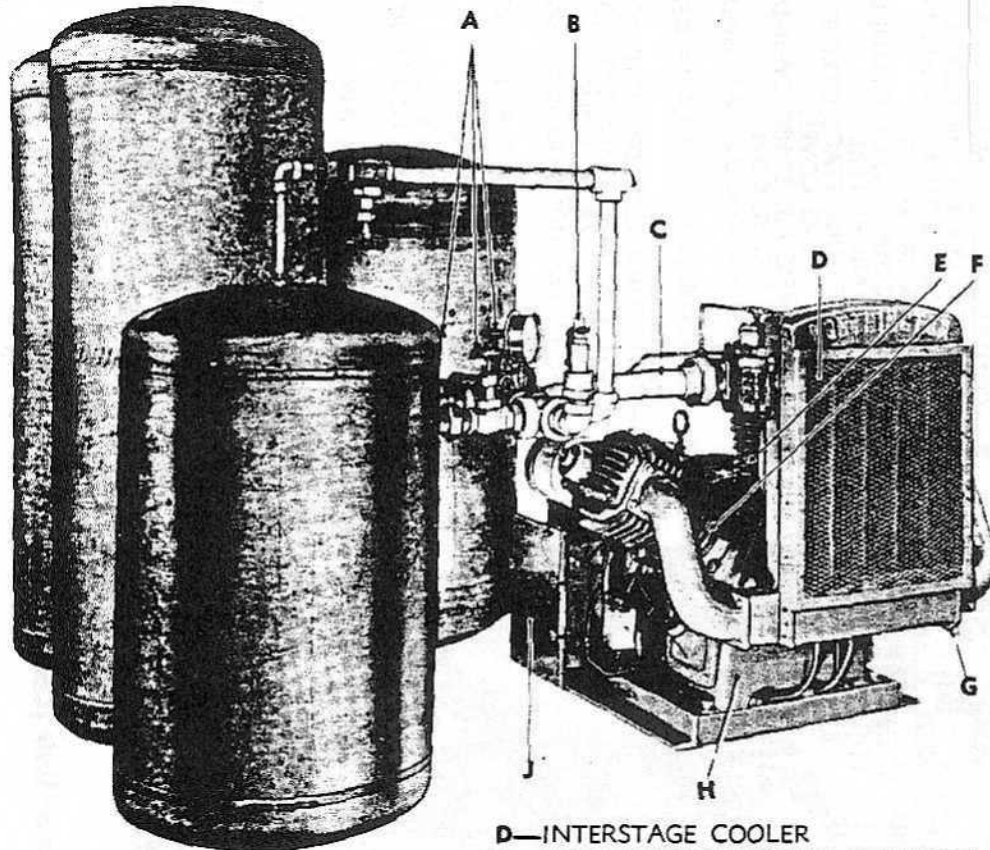

A—(TANK SHUT-OFF) REGRIND-  
ING GLOBE VALVE (200 LBS.)  
A149607

B—SAFETY POPPET VALVE A149613

C—COMPRESSOR PIPING  
(ASSEMBLY) D42630

D—INTERSTAGE COOLER

E—HIGH PRESSURE STAGE CYLINDER

F—LOW PRESSURE STAGE CYLINDER

G—INTERSTAGE COOLER DRAIN COCK

H—COMPRESSOR CRANK CASE

J—PRESSURE SWITCH AND MAGNETIC  
UNLOADER BOX

RA PD 38738

Figure 59—Compressor and Accumulator

j. **Air Compressor.** The air compressor (fig. 58) is two-stage, air-cooled, and motor-driven. It is installed on the left side of the carriage below the inner platform. Access to the compressor is by means of a ladder leading from a trap door opening in the carriage platform. Air leaving the compressor at a pressure of approximately 150 pounds per square inch is brought to four storage tanks (fig. 59) through a main pipe line (C, fig. 59) from which a separate branch containing a shut-off valve (A, fig. 59) leads to each tank. These valves are provided for shutting off the air to any individual tank in case of leakage. A means of checking the air pressure is provided by an air gage (B, fig. 60) located in the main pipe line.

(1) In order to limit the air pressure to a maximum of 155 pounds per square inch and a minimum pressure of 135 pounds per square inch, the system is equipped with a pressure switch (A, fig. 61, and V, fig. 58) and magnetic unloader (B, fig. 61) which will automatically either open

A—AIR STORA  
B—PRESSURE  
C—AIR STORA  
D—AIR STORA  
E—INTAKE A  
F—COMPRESSO

and close th  
interrupt an  
the limits of  
dual control  
continuously  
quently, or  
start when t  
the air press  
(2) The  
two air filter  
(3) separate uni  
22.

DESCRIPTION AND FUNCTIONING

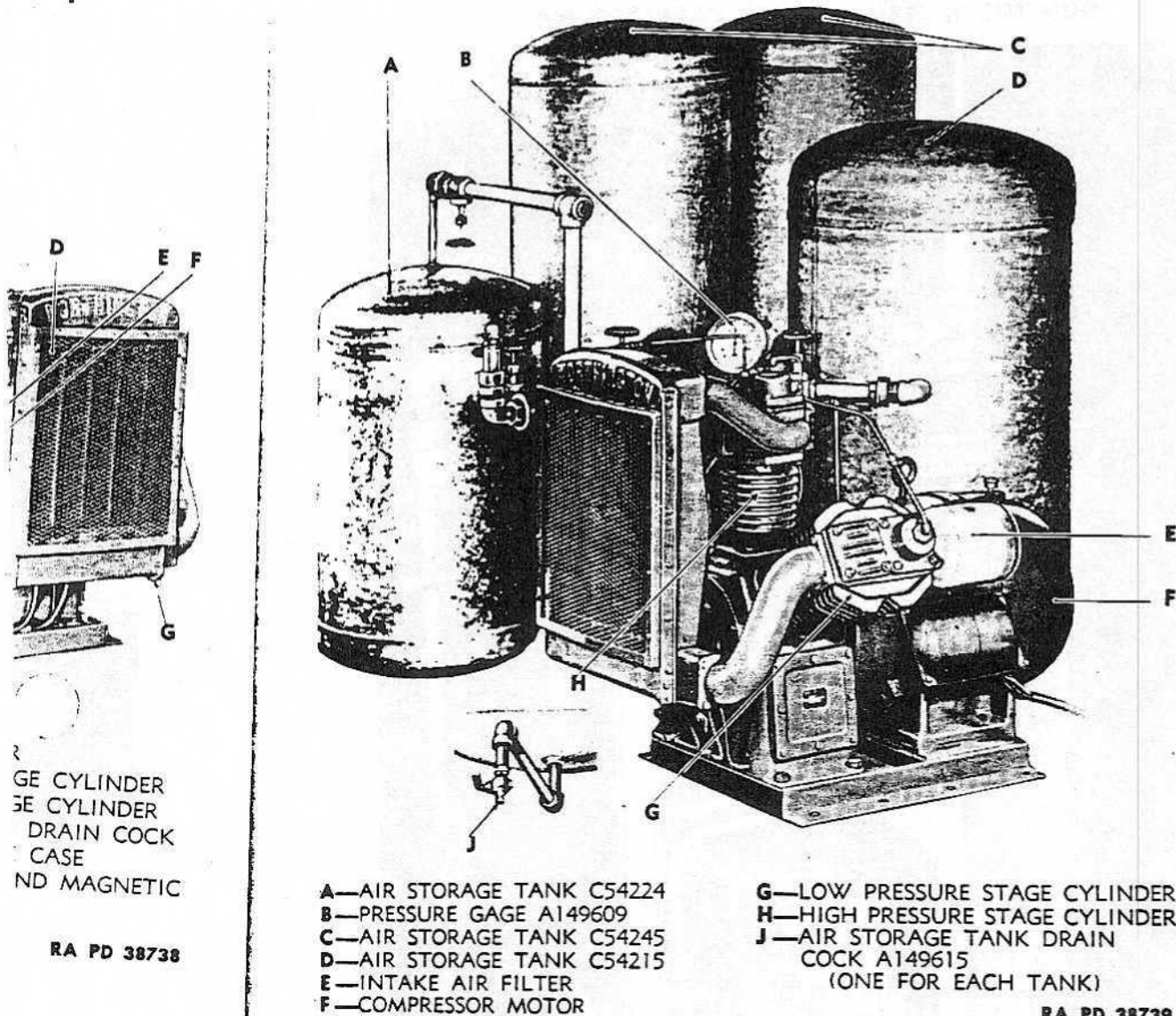

GE CYLINDER  
SE CYLINDER  
DRAIN COCK  
CASE  
ND MAGNETIC

RA PD 38738

A—AIR STORAGE TANK C54224  
B—PRESSURE GAGE A149609  
C—AIR STORAGE TANK C54245  
D—AIR STORAGE TANK C54215  
E—INTAKE AIR FILTER  
F—COMPRESSOR MOTOR

G—LOW PRESSURE STAGE CYLINDER  
H—HIGH PRESSURE STAGE CYLINDER  
J—AIR STORAGE TANK DRAIN  
COCK A149615  
(ONE FOR EACH TANK)

RA PD 38739

Figure 60—Compressor and Accumulator

and close the electric circuit leading to the compressor motor, or will interrupt and reestablish the pumping action of the compressor when the limits of pressure are reached without stopping the compressor. This dual control of the compressor system permits the compressor to run continuously during maneuvers when air pressure will be used frequently, or causes the compressor motor to automatically stop and start when the gun is standing at alert and long intervals elapse before the air pressure drops sufficiently to require replenishment.

(2) The air is drawn into the low pressure stage cylinders through two air filters (F, fig. 58) and (fig. 65).

(3) For carriages No. 23 and up, the motor and compressor are separate units, their function being the same as for carriages Nos. 20 to 22.

two-stage, air-  
of the carriage  
y means of a  
platform. Air  
0 pounds per  
ough a main  
ining a shut-  
provided for  
age. A means  
(B, fig. 60)

155 pounds  
s... inch,  
d... (g. 58)  
either open



16-INCH SEACOAST GUN MATERIEL  
GUN MK. II M1; BARBETTE CARRIAGE M4

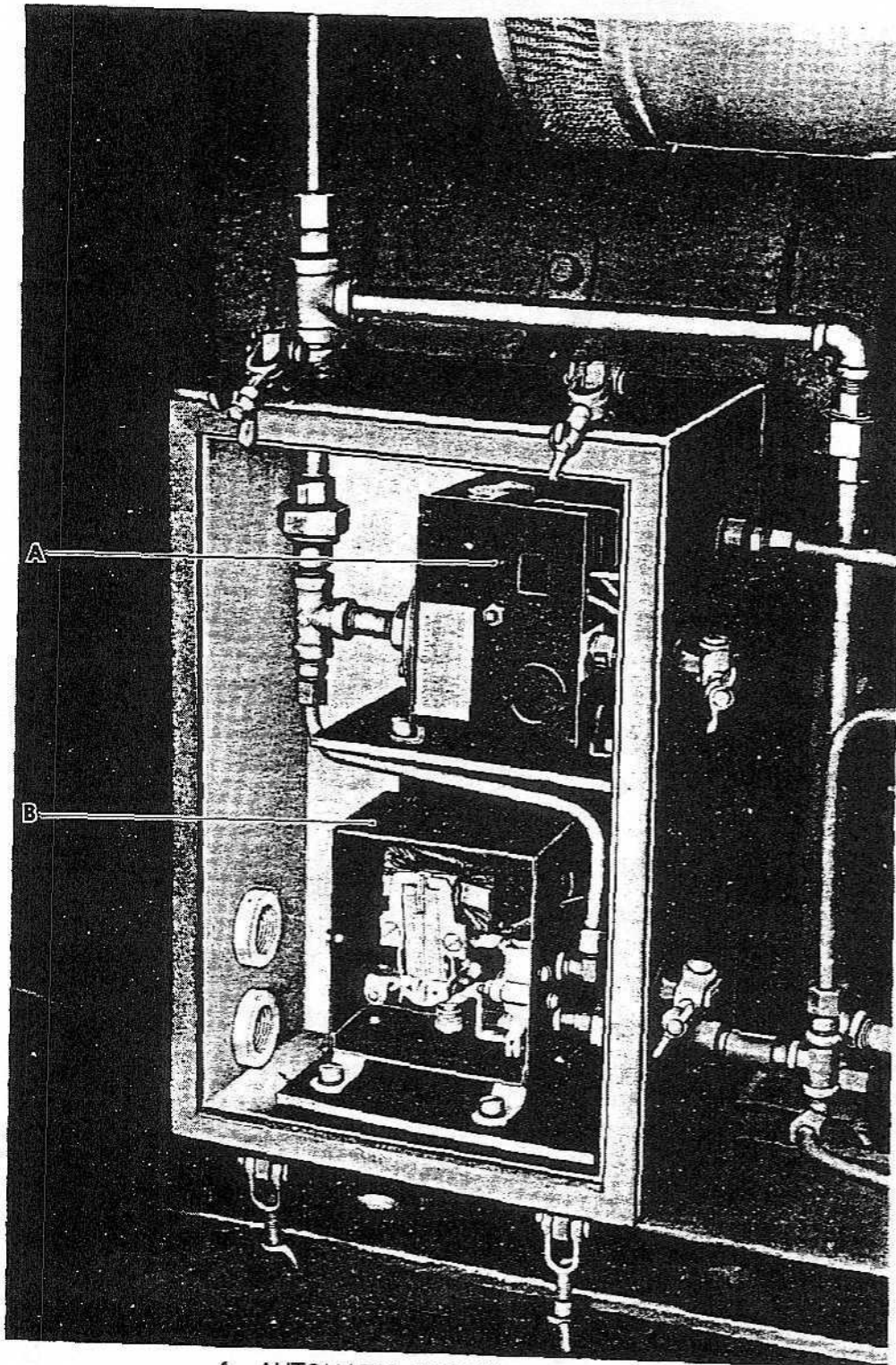

A

B

A—AUTOMATIC PRESSURE SWITCH  
B—MAGNETIC UNLOADER

RA PD 38740

Figure 61—Automatic Pressure Switch and Magnetic Unloader

Figure 62—C.

### DESCRIPTION AND FUNCTIONING

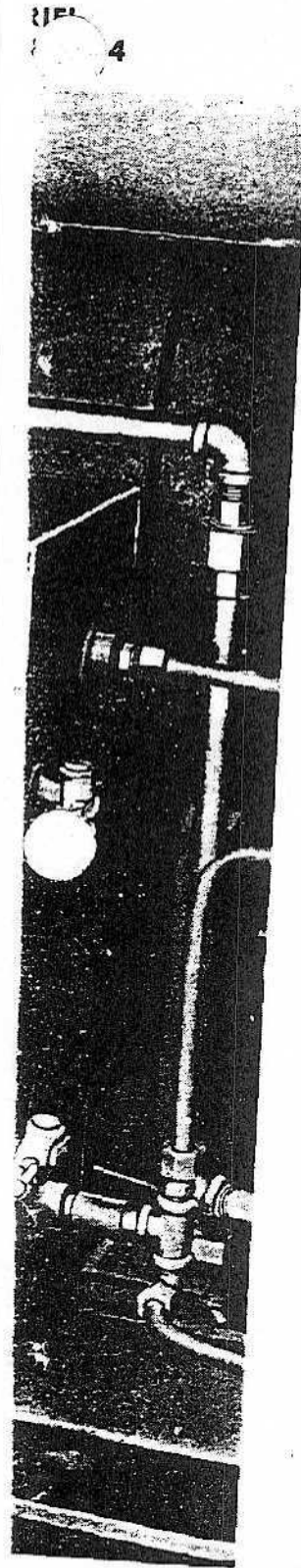

RA PD 38740

c Jader

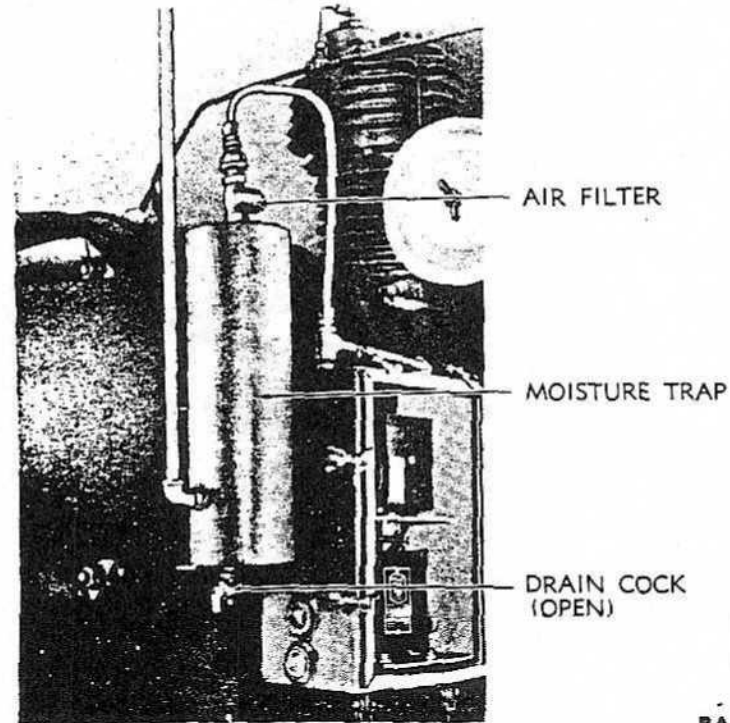

RA PD 38741

Figure 62—Control System Moisture Trap and Air Filter  
(Drain Cock Open)

TM 9-471  
6

**16-INCH SEACOAST GUN MATERIEL  
GUN MK. II M1; BARBETTE CARRIAGE M4**

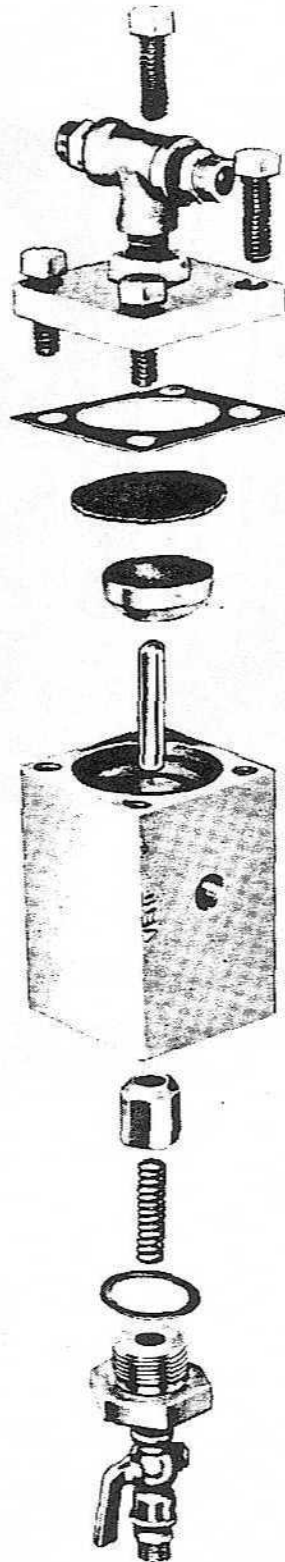

PRIMING  
COCK  
CLOSED

PRIMING COC

RA PD 38742

Figure 63—Unloading System Upper Relay Valve—Exploded View

l  
l  
l  
v  
t  
t  
l

DESCRIPTION AND FUNCTIONING

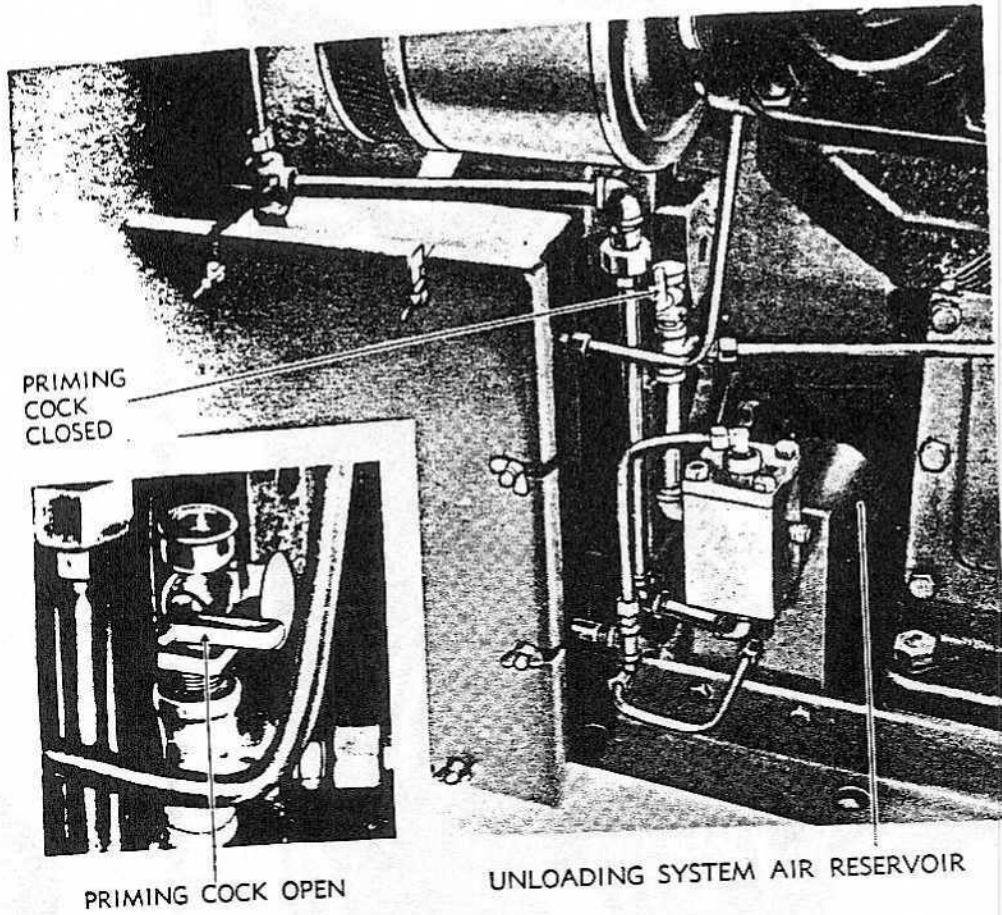

RA PD 38743

Figure 64—Unloading System Priming Cock

16-INCH SEACOAST GUN MATERIEL  
GUN MK. II M1; BARBETTE CARRIAGE M4

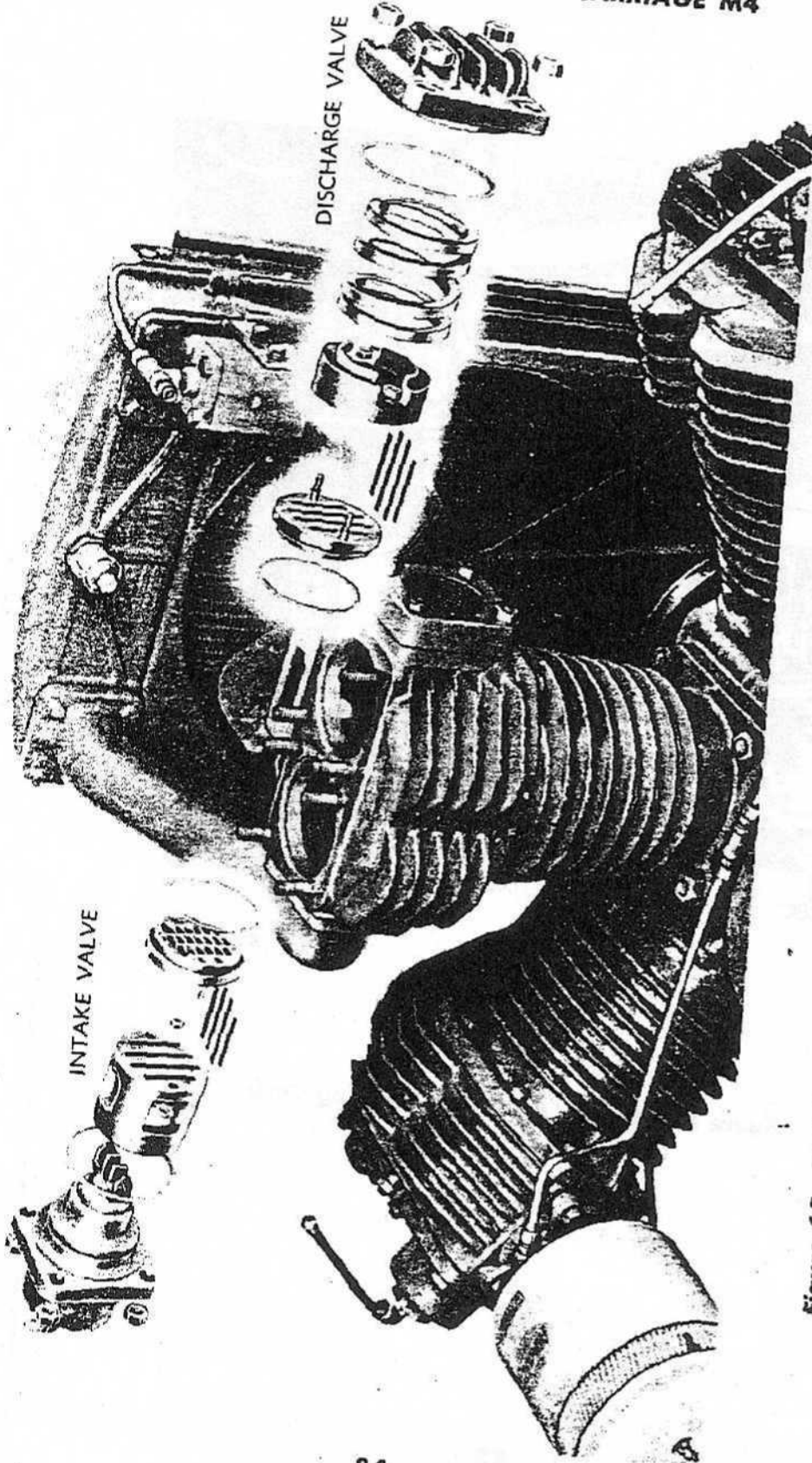

RA PD 38745  
Figure 65—High Pressure Stage Cylinder (Intake and Discharge) Valves—Exploded View



DISCHARGE VALVE

DISCHARGE VALVE

Figure 65—High Pressure Stage Cylinder (Intake and Discharge) Valves—Exploded View

RA PD 38745



DESCRIPTION AND FUNCTIONING

TM 9-471  
6

RA PD 38744

Figure 65-1—Low Pressure Stage Cylinder (Intake and Discharge) Valves—Exploded View

16-INCH SEACOAST GUN MATERIEL  
GUN MK. II M1; BARBETTE CARRIAGE M4

- A—PLUG TO BE REPLACED BY INTERSTAGE PRESSURE GAGE
- B—INTERSTAGE SAFETY POP VALVE
- C—UNLOADING SYSTEM UPPER RELAY VALVE
- D—INTERSTAGE COOLER VENT COCK
- E—HIGH PRESSURE STAGE CYLINDER INTAKE VALVE COVER
- F—UNLOADING SYSTEM PIPING (TO THE INTAKE VALVE UNSEATING PLUNGERS OF ALL THREE CYLINDERS)
- G—HIGH PRESSURE STAGE CYLINDER
- H—LOW PRESSURE STAGE CYLINDERS
- J—OIL PRESSURE GAGE
- K—INTERSTAGE COOLER

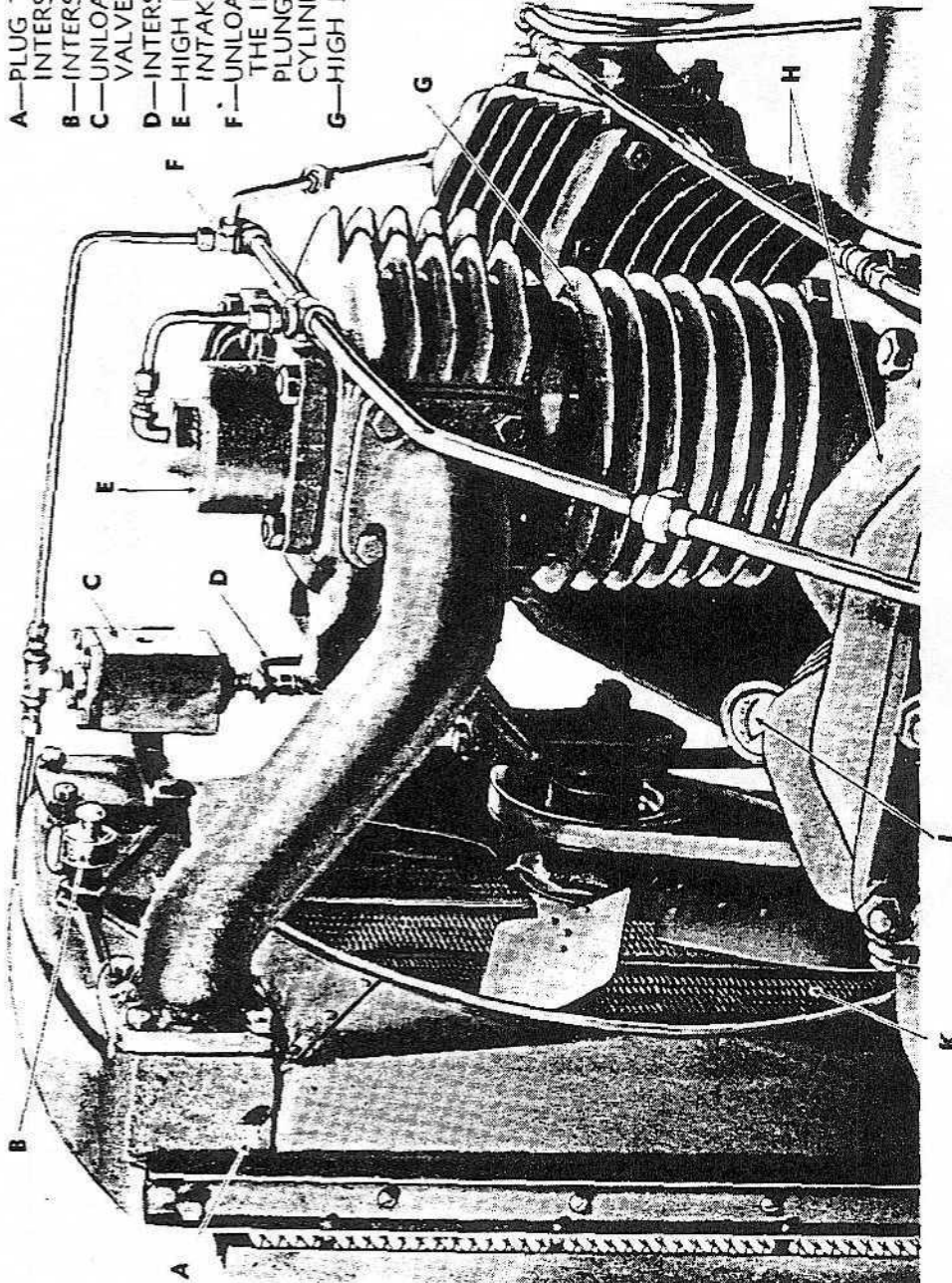

RA PD 38746

Figure 66—Compressor (Close-up)

k. Elevating (plished either by n

(1) ELEVATING

(a) Elevation elevating motor (speed gear trans 70) through a str operate by power wheel is moved t hole in the clutch engages the pow (F, fig. 87, and L the gun. The mot ator at the follow

(b) Control c before the extren of elevation and the right elevati and M, fig. 87), causes the thus stoppi action of the spe the knee on rele

(2) ELEVATI

(a) Elevation motion) is perf position marked rotation of the l rack through th turn of elevat minutes.

(b) Elevatic by means of th crank is being t clutch lever are counterclockwis must be remov

(3) ELEVAT

bearing (fig. 7 elevation poin enable t angle, the an indicator.

## DESCRIPTION AND FUNCTIONING

k. **Elevating Group.** Elevation or depression of the gun is accomplished either by motor or by hand power.

## (1) ELEVATING BY POWER.

(a) Elevation of the gun by power is accomplished by means of an elevating motor (fig. 69) acting through a hydraulic speed gear. This speed gear transmits power by means of a vertical drive shaft (N, fig. 70) through a train of gears connecting with the elevating rack. To operate by power, the clutch lever (F, fig. 74) near the elevating handwheel is moved to engage the clutch lever handle plunger in the outer hole in the clutch lever arc (G, fig. 74). Placing the lever in this position engages the power clutch in the train of gears to the elevating pinion (F, fig. 87, and L, fig. 88) and rack which operates to elevate or depress the gun. The motion of elevation or depression is controlled by the operator at the follow-up control handwheel (M, fig. 74, and J, fig. 68).

(b) *Control of Speed Gear.* The speed gear is stopped automatically before the extreme limit of elevation or depression is reached by means of elevation and depression cams (H, fig. 72, and X, fig. 87) attached to the right elevating rack. When the cams strike the cam lever (T, fig. 72, and M, fig. 87), a movement of the connected parts takes place which causes the control shaft stop clutches (fig. 68) to come into engagement, thus stopping the movement of the control shaft which in turn stops the action of the speed gear. The clutches may be released by pressure from the knee on release lever (T, fig. 74).

## (2) ELEVATING BY HAND.

(a) Elevation by hand from the right side of the mount (slow-motion) is performed by moving the clutch lever (F, fig. 74) to the position marked "HAND" on lever arc (G, fig. 74). In this position, rotation of the handwheel (E, fig. 74) transmits motion to the elevating rack through the same train of gears as is used in power elevation. One turn of elevating handwheel counterclockwise elevates gun 56.509 minutes.

(b) Elevation by hand on the left side (fast-motion) is accomplished by means of the elevating crank (fig. 136). When the hand elevating crank is being used the clutch lever must be in "HAND" position on the clutch lever arc on the right side of the mount. One turn of the crank counterclockwise elevates the gun 2 degrees 56.897 minutes. (The crank must be removed when elevating by power.)

(3) **ELEVATION POINTER.** The outer face of the cradle trunnion bearing (fig. 76) on the right side frame is graduated in degrees and an elevation pointer (J, fig. 76) is fastened to the trunnion of the cradle to enable the gun commander to set the gun approximately to the desired angle, the final setting being determined by readings on the elevation indicator.

RA PD 38746

Figure 66—Compressor (Close-up)



### 16-INCH SEACOAST GUN MATERIEL GUN MK. II M1; BARBETTE CARRIAGE M4

(4) **TRUNNION ROLLER BEARINGS.** A floating mechanism for the trunnion bearings is being considered for future manufacture, and will replace the present antifriction device. This antifriction device is mounted on each side frame (figs. 76 and 77) to reduce the effort required to elevate or depress the gun. This is accomplished by supporting the weight of the gun with tipping parts on roller bearings assembled in the cradle trunnions. The antifriction lever (P, fig. 76) is supported at one end by a spring rod (A, fig. 76) which passes through the lever and a rib on the side frame. Belleville springs (D, fig. 76) with spring rod collar nuts (C, fig. 76) are assembled on the rod. The forward end of the lever rests on a spool (K, fig. 76) which is supported by a step (L, fig. 76) bolted to a web on the side frame. A crutch (E, fig. 77, and A, fig. 78) is placed with its lower end supported in a seat on the lever, its upper end projecting up through the outer end of the trunnion bed and into a slot in the lower side of the cradle trunnion (fig. 56). The crutch supports the trunnion roller bearing (B, C, and D, fig. 78). The bearing pin (E, fig. 78) is bolted to the end of the trunnion and projects into a bore in the end of the trunnion through the roller bearing sleeve (D, fig. 78). The diameter of each trunnion extension (D, fig. 56) is 0.016 inch smaller than the bore of the trunnion bed and cap (figs. 40 and 43). After the tipping parts have been placed in the side frames the trunnions are raised from their seats in the trunnion beds until they clear by 0.008 inch (fig. 137). The tipping parts are then entirely supported by the crutches (E, fig. 77, and A, fig. 78). This condition is obtained by adjustment of the spring rod collar nuts (C, fig. 76) on spring rod (A, fig. 76). The weight of all tipping parts is now carried on the roller bearings. This condition exists at all times except when the gun is fired, at which time the force due to recoil compresses the Belleville springs (D, fig. 76), and the trunnions are seated in the bearings in the side frames. After the effect of the recoil has been absorbed the trunnions return to their original position.

(5) **ELEVATING BRAKES.** The elevating brake mechanism is designed to hold the gun at any angle of elevation. The brakes also prevent rotation of the tipping parts during recoil of the gun. The normal position of the brakes is *locked* and they must be released before power is applied to elevate or depress the gun by lifting the brake levers (fig. 135) until they are in contact with the brake lever stop (T, fig. 68).

(a) The brake drums (E, fig. 84) are located on the right and left side frames and are operatively connected through the two trains of elevating gears with the two elevating racks. The brakes on the right and left sides of the carriage are similar, but both brake levers are on the right side of the carriage (fig. 135). Reach rods (B, fig. 80) and a cross shaft (W, fig. 80) connect the left brake to its brake lever.

(b) The brake bands with linings attached (C and D, fig. 84) encircle the drums. A clearance of  $\frac{1}{32}$  inch must be maintained between

the brake bands are released in (E, fig. 83) a clearance (fig

(c) A cone the brake drum this spring is pressure is shown to the spring shoulder is increased. Normal when the brake

(d) The 185) anchor of fig. 68, and A of the brake

(6) ELEV absorb the shock other tipping

(a) These of the racks (L attached to the outward in the elevating racks.

(b) As the stops contact This action is 88). Any pressure either an upward of the lever, the springs, stopping of the

(7) RANGE located on the wheel, enable given range pointers, one electrical pointer in conjunction pointer is off from a rack elevated or gears of the showing

(a) mechanism relation to the

## DESCRIPTION AND FUNCTIONING

the brake band lining and the brake drum (fig. 84) when the brakes are released in order to prevent dragging of the brakes. Turning the nut (E, fig. 83) adjusts the spring support of each brake band to obtain this clearance (fig. 84).

(c) A compressed spring (J, fig. 79) causes each brake band to grip the brake drum when the brake levers are released. The compression of this spring is adjusted by turning nut (C, fig. 83). The amount of compression is shown by the position of the shoulder of this nut with relation to the spring indicator (B, fig. 83). If the nut is tightened so that the shoulder is below the indicator the compression of the spring is increased. Normally this shoulder should be flush with the spring indicator when the brake is locked.

(d) The brake band adjusting rod brackets (K, fig. 86, and C, fig. 85) anchor one end of each brake band to the adjacent gear plate (G, fig. 68, and A, fig. 86). One of the nuts (fig. 85) provides an adjustment of the brake band for wear, the other nut locks this adjustment.

(6) ELEVATING BUFFERS. The elevating buffers (figs. 87 and 88) absorb the shock which results from sudden stopping of the gun and other tipping parts at extreme elevation or depression.

(a) These buffers are self-contained units, bolted to the lower edges of the right and left side frames so as to make contact with the elevating racks (B, fig. 87, and Q, fig. 88). Buffer levers (W, fig. 87, and H, fig. 88) attached to the buffer housing brackets (V, fig. 87, and S, fig. 88) extend outward in the path of the elevating and depressing stops on the elevating racks.

(b) As the rack reaches its maximum limits in either direction the stops contact the buffer lever stopping the rotation of the tipping parts. This action is cushioned by the Belleville springs (Q, fig. 87, and B, fig. 88). Any pressure on the rack end of the buffer lever resulting from either an upward or downward movement is transmitted to the other end of the lever, causing compression of the Belleville springs. Yielding of the springs under pressure absorbs the shock resulting from sudden stopping of the tipping parts.

(7) RANGE DATA INDICATOR. An elevation data indicator (S, fig. 74), located on the right side of the carriage near the elevating control hand-wheel, enables the gunner to set the gun to the correct angle for any given range (fig. 135). The range data indicator contains two sets of pointers, one operated electrically and one by mechanical means. The electrical pointer is controlled and operated from an off-carriage station in conjunction with the range finding mechanism. The mechanical pointer is operated through a drive mechanism (fig. 89) and is driven from a rack (C, fig. 89) attached to the cradle. As the tipping parts are elevated or depressed the rotation is transmitted through the train of gears of the drive mechanism to the mechanical pointer of the indicator showing the position of the gun in elevation.

(a) A zero adjusting device (fig. 89) is located in the indicator drive mechanism which provides a means for setting the mechanism in proper relation to the position of the gun in elevation.

16-INCH SEACOAST GUN MATERIEL  
GUN MK. II M1; BARBETTE CARRIAGE M4

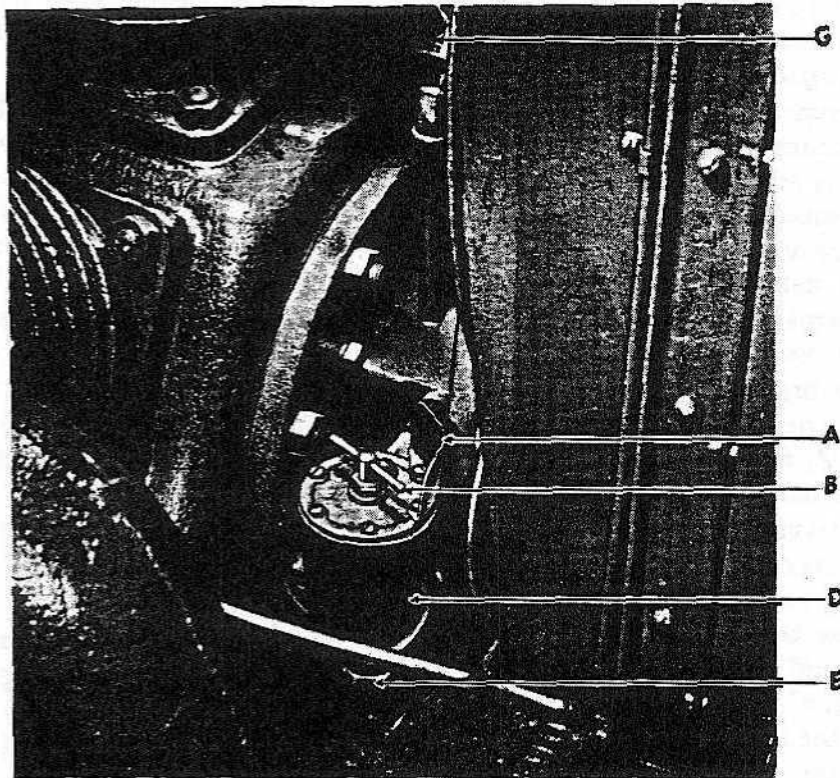

RA PD 38748A

Figure 67—Oil Filter  
(LEGEND ON OPPOSITE PAGE)

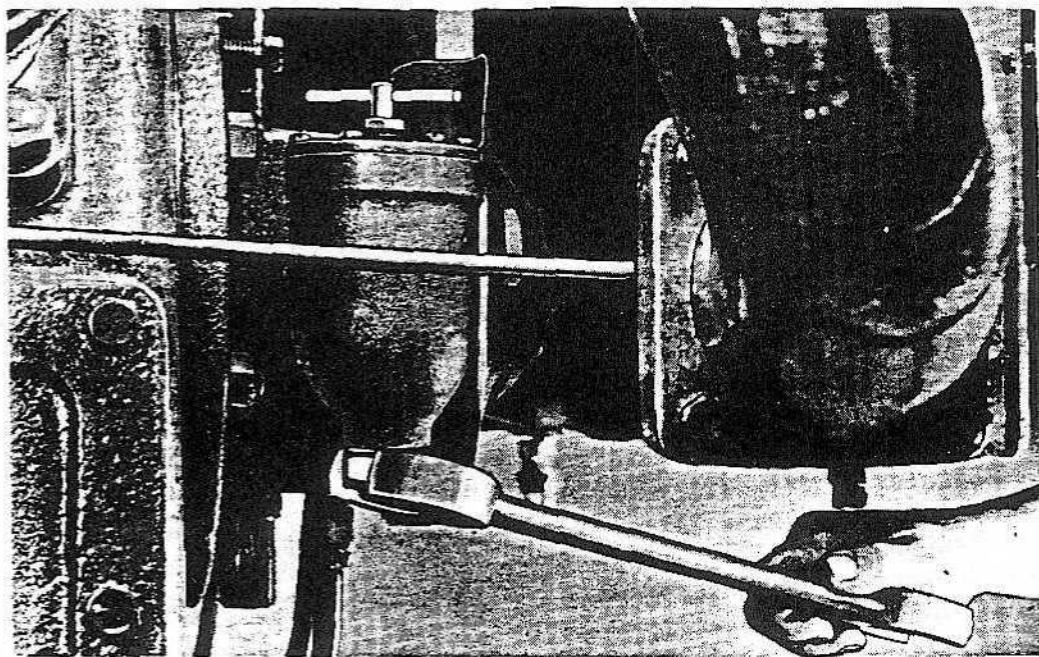

RA PD 38748

Figure 67-1—Removing Oil Filter Drain Plug

### DESCRIPTION AND FUNCTIONING

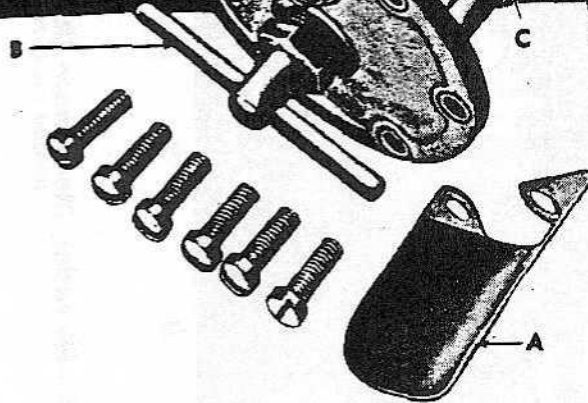
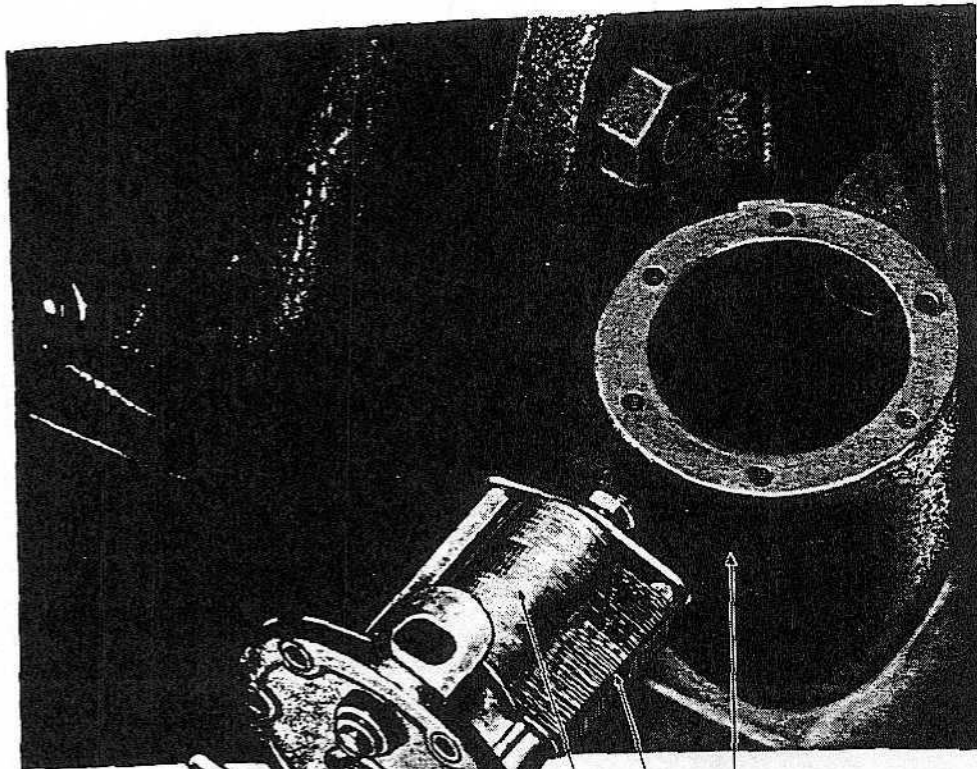
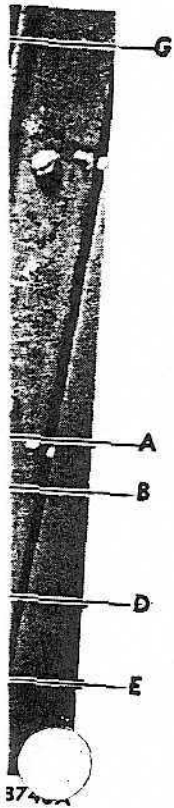

- A—FINGER GUARD
- B—AGITATOR HANDLE
- C—FILTER ELEMENT
- D—FILTER HOUSING
- E—FILTER HOUSING DRAIN PLUG
- F—FILTER AGITATOR
- G—OIL PRESSURE GAGE

RA PD 38747

Figure 67-2—Filter Element Removed for Cleaning

TM 9-471  
6

16-INCH SEACOAST GUN MATERIEL  
GUN MK. II M1; BARBETTE CARRIAGE M4

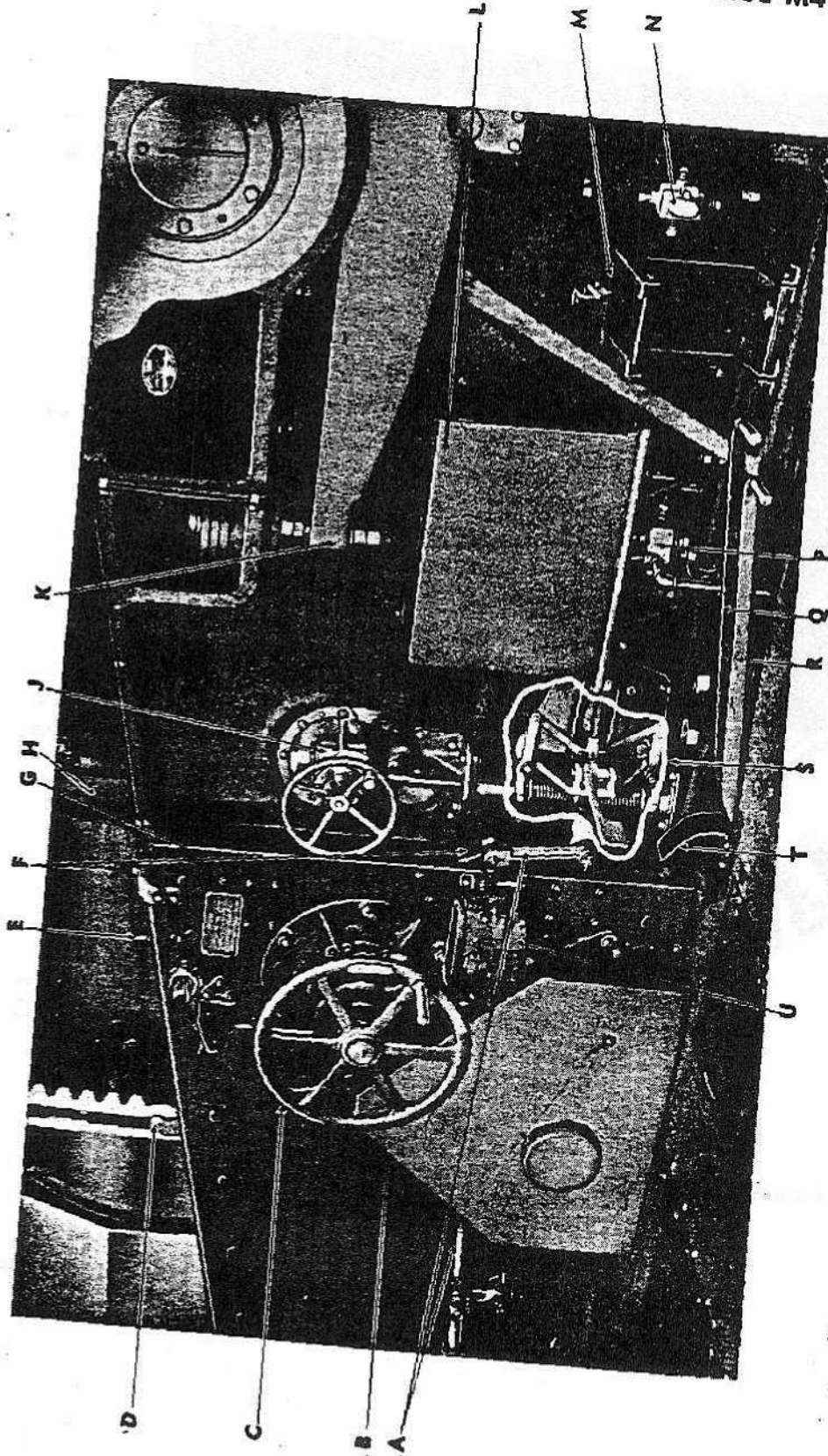

RA PD 38749

Figure 68—Elevating Mechanism (Right Side—Gear Guard in Place)  
(LEGEND ON OPPOSITE PAGE)

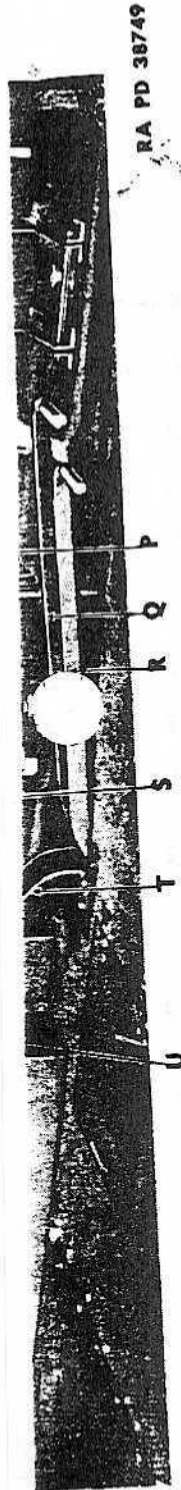

RA PD 38749

**Figure 68—Elevating Mechanism (Right Side—Gear Guard in Place)**  
(LEGEND ON OPPOSITE PAGE)

**DESCRIPTION AND FUNCTIONING**

- A**—ELEVATING FOLLOW-UP CONTROL ASSEMBLY D42543
- B**—RIGHT ELEVATING GEAR GUARD D42644
- C**—ELEVATING GEAR (RIGHT SIDE) (ASSEMBLY) D42542
- D**—LOADING POSITION POINTER C3018
- E**—ELEVATING BRAKE BAND SUPPORT (ASSEMBLY) B163052
- F**—ELEVATING BRAKE (ASSEMBLY) D1211
- G**—RIGHT ELEVATING GEAR PLATE D42605
- H**—ELEVATION DATA INDICATOR DRIVE RACK D42314
- J**—ELEVATING FOLLOW-UP CONTROL HANDWHEEL (ASSEMBLY) D42640
- K**—ANTI-FRICTION (ASSEMBLY)
- L**—ELEVATING SPEED GEAR OIL EXPANSION TANK AND PIPING (ASSEMBLY) D42640
- M**—HINGED STEP (ASSEMBLY) D42609
- N**—ELEVATING MOTOR COMPARTMENT LIGHT SWITCH BOX B162567 AND SCREW BCAX1BD
- P**—FOUR-WAY JUNCTION BOX B162523 AND SCREW BCAX1BD
- Q**—LEFT BRAKE RELEASE LEVER C54980
- R**—RIGHT BRAKE RELEASE LEVER C54981
- S**—CONTROL SHAFT STOP CLUTCH RELEASE (ASSEMBLY) C54961
- T**—BRAKE RELEASE LEVER STOP C54910—SCREW BCAX2AB AND NUT BBAX2B
- U**—ELEVATION DATA INDICATOR M5 D43205 AND INDICATOR DRIVE MECHANISM D41950

RA PD 38749A

**Legend for Figure 68—Elevating Mechanism**  
(ILLUSTRATION ON OPPOSITE PAGE)

16-INCH SEACOAST GUN MATERIEL  
GUN MK. II M1; BARBETTE CARRIAGE M4

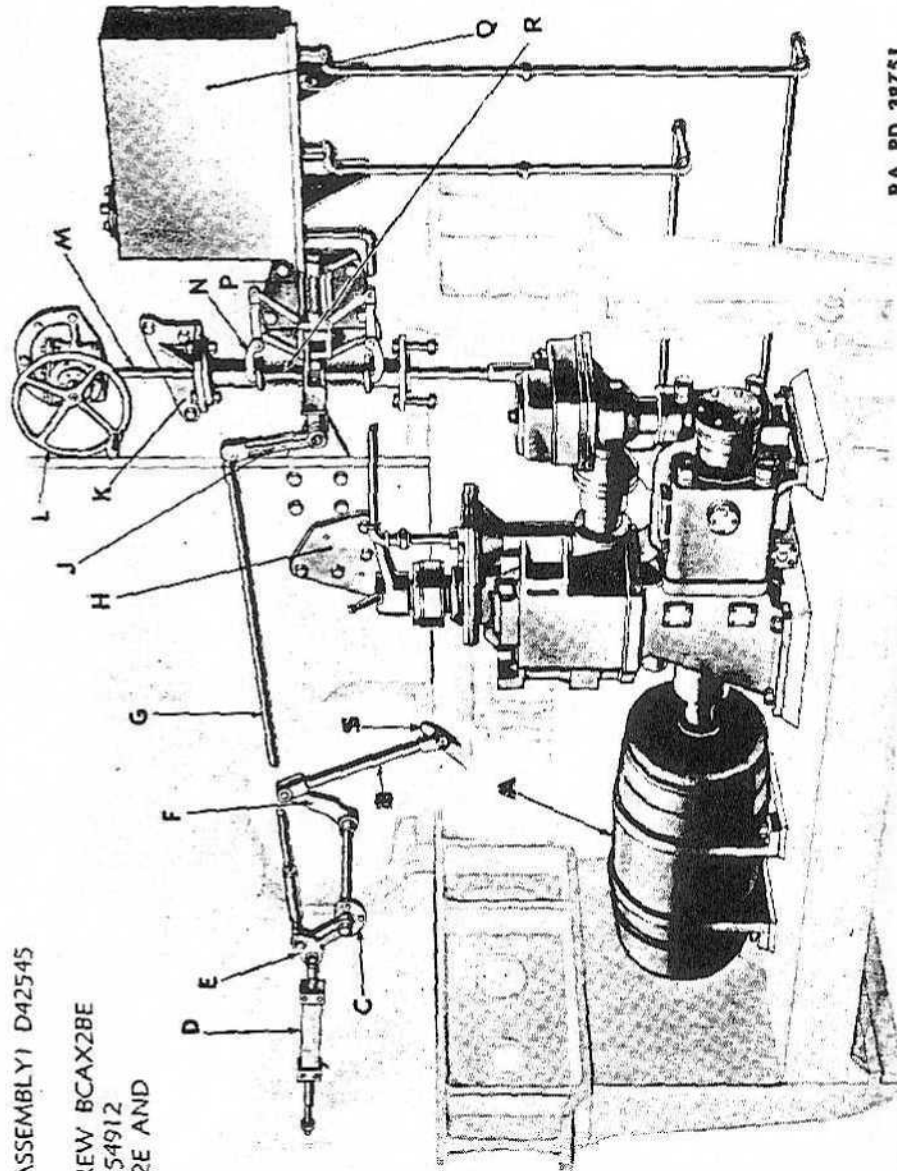

RA PD 38751

- A—MOTOR AND SPEEDGEAR (ASSEMBLY) D42545
- B—ROD (ASSEMBLY) C54451
- C—BRACKET C54963 WITH SCREW BCAX2BE
- D—SPRING BOX (ASSEMBLY) C54912
- E—LEVER B163017—NUT BBGX2E AND COTTER PIN BFAX2BC
- F—LEVER B161970
- G—CONNECTING ROD (ASSEMBLY) C54904
- H—BRACKET C54870 WITH SCREW BCAX2DH AND DOWEL A149834
- J—LEVER B163011 NUT BBGX2E AND COTTER PIN BFAX2BC
- K—BRACKET D42305
- L—HANDWHEEL C54804 WITH HANDLE (ASSEMBLY) B162919
- M—SHAFT C54871
- N—CLUTCH C54875
- P—CLUTCH RELEASE (ASSEMBLY) C54961 SCREW A149984 AND NUT BBAX2D
- Q—ELEVATING EXPANSION TANK AND PIPING (ASSEMBLY) D42640
- R—SPRING A149833
- S—CAM LEVER B161957

Figure 69—Isometric View Follow-up Control

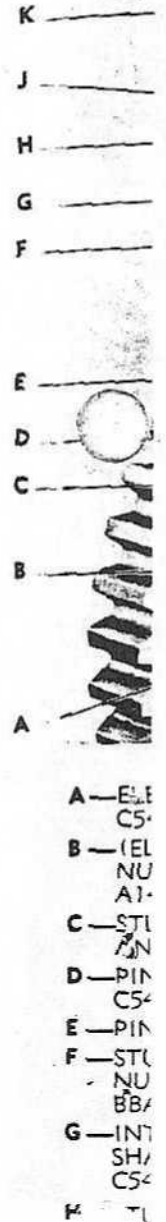
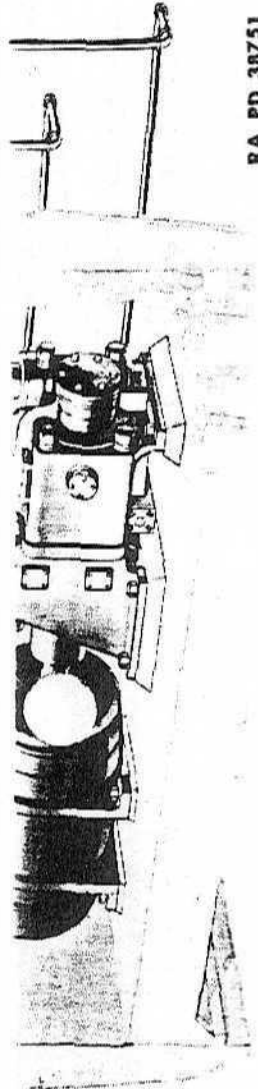

Figure 70

TERIEL  
1/ M4



RA PD 38751

Figure 69—Isometric View Follow-up Control

D—ELEVATING EXPANSION  
TANK AND PIPING  
(ASSEMBLY) D42640  
S—SPRING A149833  
—CAM LEVER B161957

TM 9-471  
6

DESCRIPTION AND FUNCTIONING

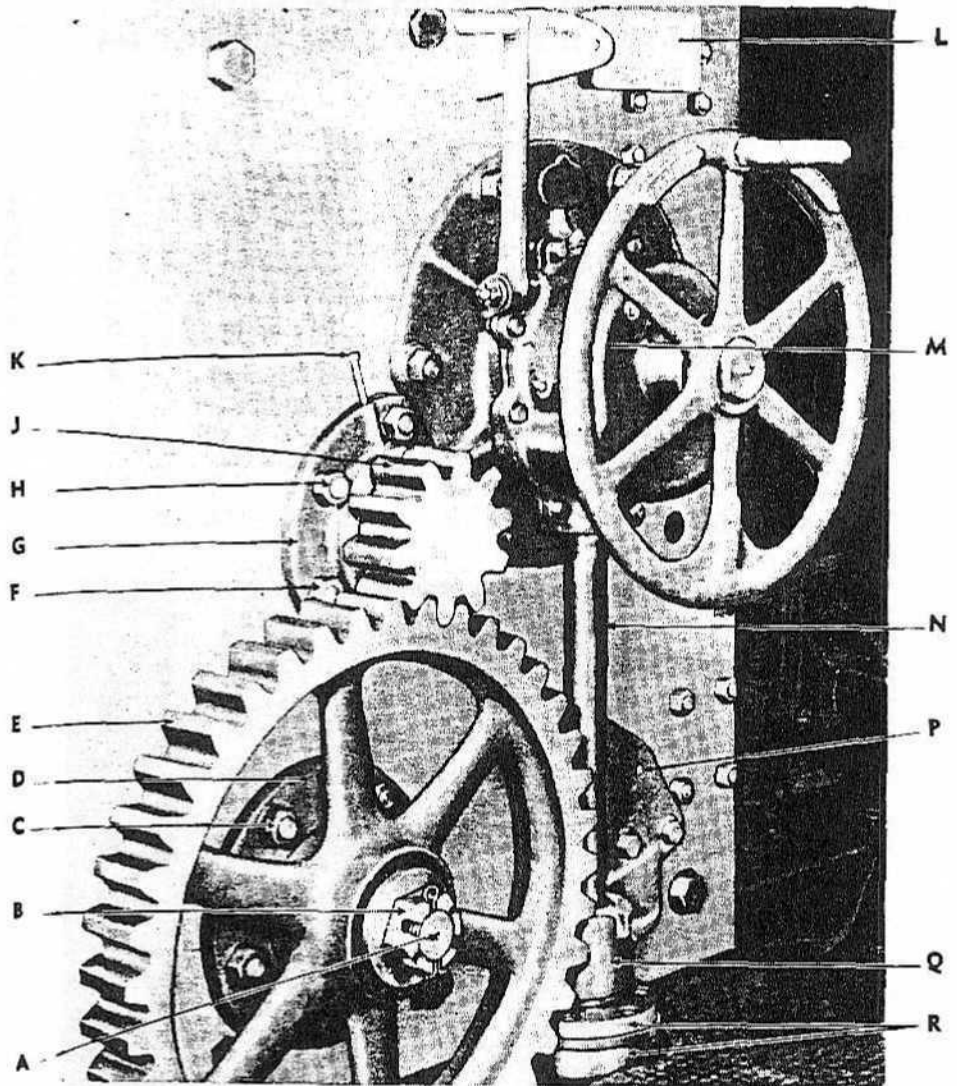

- A—ELEVATING PINION SHAFT C54855
- B—(ELEVATING PINION SHAFT) NUT A149790—WASHER A149789 AND PIN A149953
- C—STUD (ASSEMBLY) A149784 AND NUT BBAX3A
- D—PINION SHAFT BEARING C54853
- E—PINION SHAFT GEAR C54860
- F—STUD (ASSEMBLY) A149785 NUT A149786 AND NUT BBAX3A
- G—INTERMEDIATE PINION SHAFT BEARING (RIGHT) C54854A
- H—STUD (ASSEMBLY) A149784 AND NUT BBAX3A
- J—RIGHT INTERMEDIATE PINION SHAFT C54857
- K—OIL PIPE A149442 WITH PLUG A8053
- L—INSTRUCTION PLATE B126216—SCREW BCKX4EQ AND SPACER A149919
- M—ELEVATING GEAR (RIGHT SIDE) ASSEMBLY D42542
- N—(VERTICAL) POWER DRIVE SHAFT B163004
- P—DRIVE SHAFT BRACKET DOWEL A149834
- Q—DRIVE SHAFT BRACKET C54870 AND SCREW BCAX2DH
- R—"B" END DRIVE COUPLING C54692 AND KEY A149440B

Figure 70—Elevating Pinion Gear and Vertical Power Drive Shaft—Exposed View

RA PD 38752



**16-INCH SEACOAST GUN MATERIEL  
GUN MK. II M1; BARBETTE CARRIAGE M4**

- A—(RIGHT) ELEVATING GEAR PLATE D42605
- B—CRADLE AND RECOILING PARTS LOCK D49145
- C—LOADING POSITION POINTER C3018
- D—(RIGHT) ELEVATING RACK D42304A—ION CARRIAGES #19 TO 28 INCLUSIVE—FOR CARRIAGES #29 AND UP
- E—(RECOIL CYLINDER FILLING FUNNEL) BRACKET A10011 AND FERRULE RETAINER A218470
- F—ELEVATING CLUTCH LEVER B162975
- G—ELEVATING HANDWHEEL C54863
- H—FOLLOW-UP CONTROL HANDWHEEL (ASSEMBLY) D42307
- J—(FOLLOW-UP CONTROL CLUTCH FORK LEVER) CONNECTING ROD (ASSEMBLY) C54904
- K—(FOLLOW-UP CONTROL) CONNECTING LEVER B163017
- L—(FOLLOW-UP CONTROL CLUTCH CENTERING) SPRING BOX (ASSEMBLY) C54912

RA PD 38754

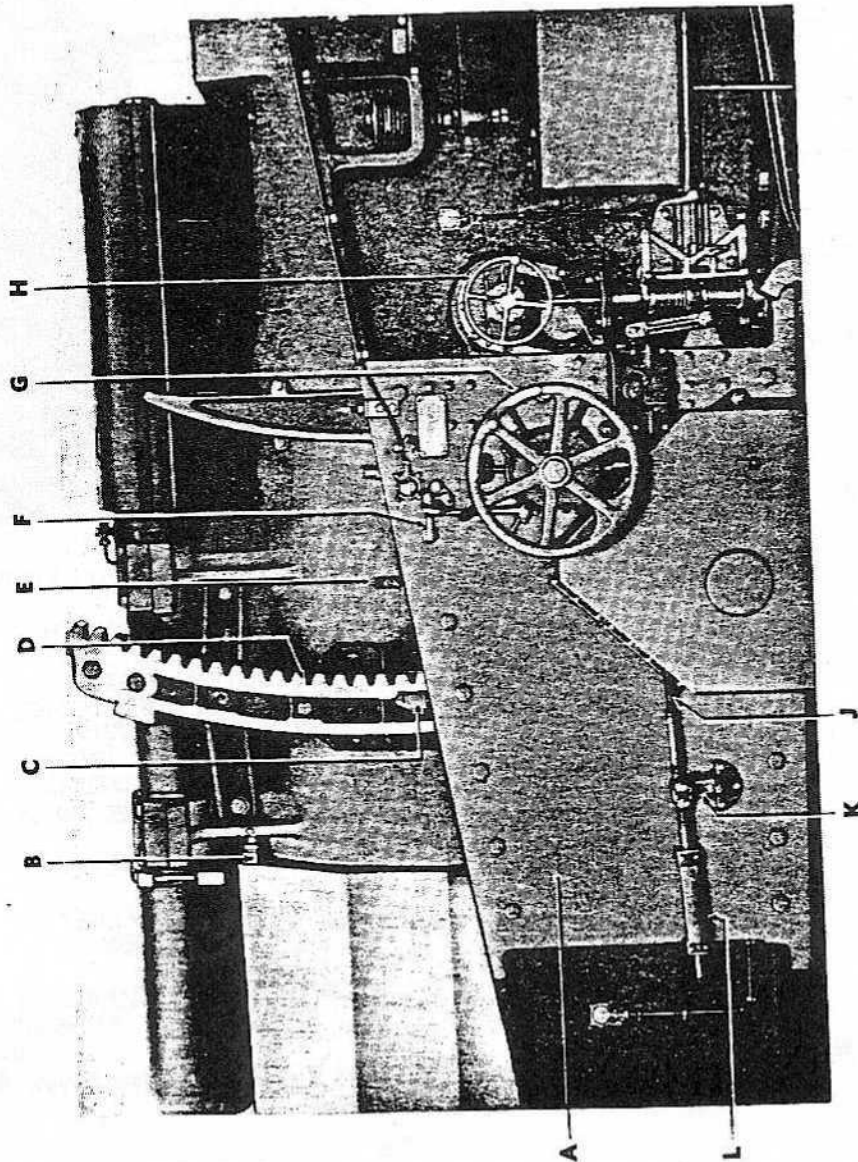

**Figure 71—Elevating Handwheel and Follow-up Control**

- A—RIGHT ELEVATING RACK BRACKET D42365A
- B—(STOP) BOLT B162404 AND NUT BBAX3D
- C—RIGHT ELEVATING RACK
- D—ELEVATING POSITION SHAF C54855

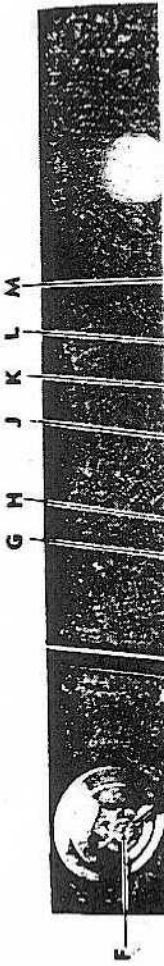

DESCRIPTION AND FUNCTIONING

- A—RIGHT ELEVATING RACK BRACKET D42365A
- B—(STOP) BOLT B162404 AND NUT BBAX3D
- C—RIGHT ELEVATING RACK
- D—ELEVATING PINION SHAFT C54855
- E—RIGHT ELEVATING RACK AND PINION GUARD C52770A AND SCREW BCAX2BB
- F—ELEVATING INTERMEDIATE PINION SHAFT C54857 WITH NUT A149793 —WASHER A149792 AND COTTER PIN BFAX2EN
- G—RIGHT BUFFER ELEVATION STOP B162386A
- H—FOLLOW-UP CONTROL ELEVATION CAM B161969
- J—LEVER ROD (ASSEMBLY) C54451
- K—LEVER ROD PIN A148883 WITH COTTER PIN BFAX2BD
- L—ROD LEVER B161970
- M—LEVER SHAFT B163022 WITH KEY BGHX2EG
- N—BOLT A148368 AND NUT BBAX3E
- P—RIGHT REAR FLOOR BEAM D42556
- Q—BUFFER SLIDE B161953 WITH PLATE WASHER A148882 AND SET SCREW A148812
- R—BUFFER STUD B161956
- S—RIGHT ELEVATING BUFFER (ASSEMBLY) D42145
- T—FOLLOW-UP CONTROL CAM LEVER B161957

RA PD 38755

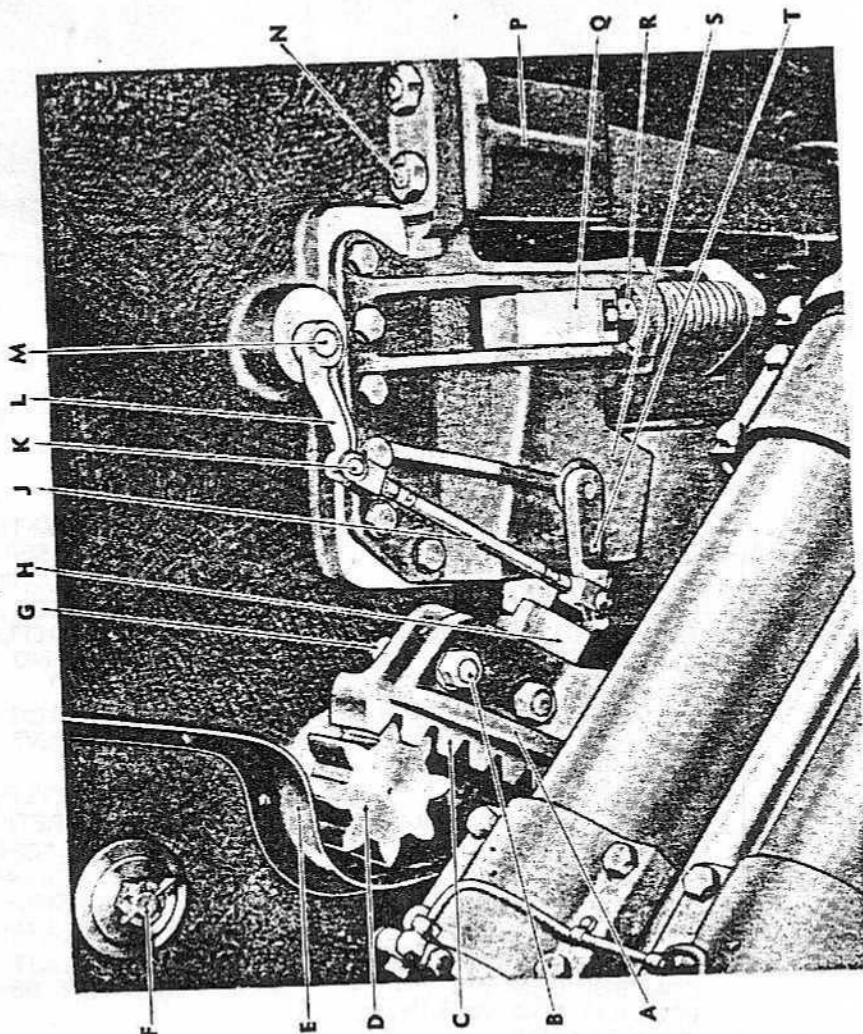
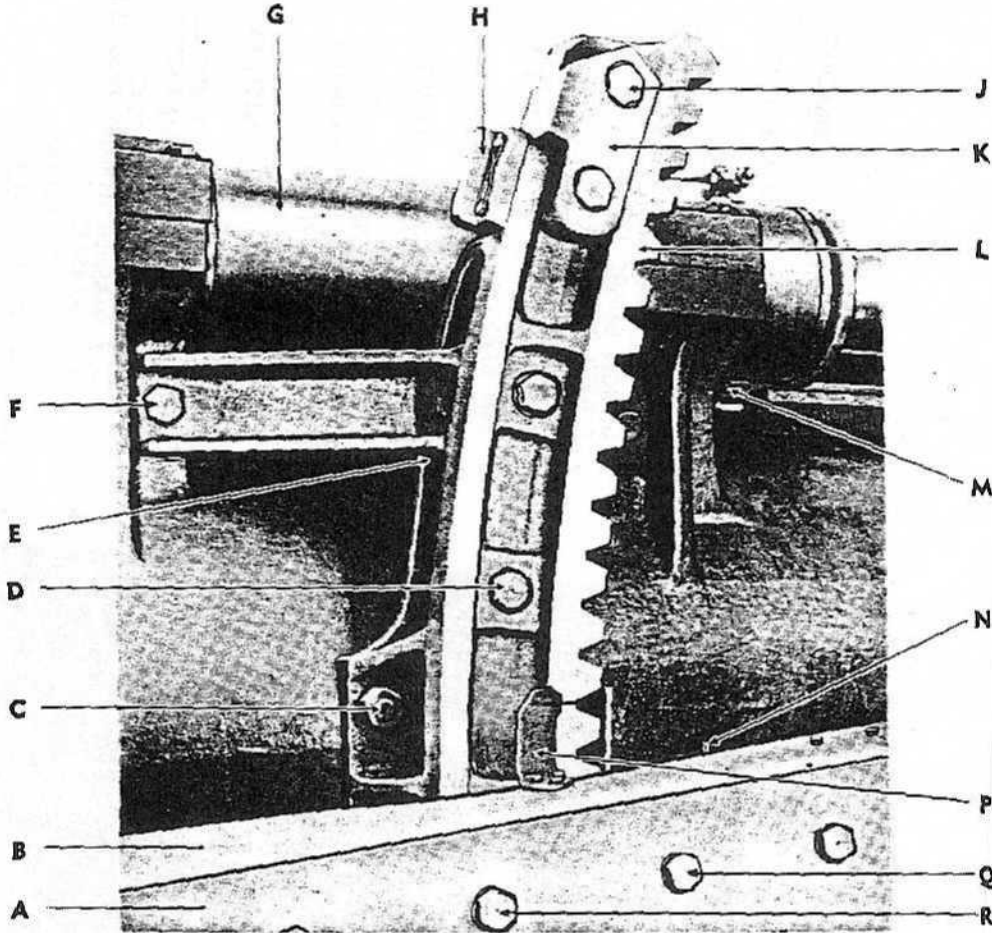

Figure 72—Elevating Follow-up Control Cam Lever Engaging Elevation Cam

16-INCH SEACOAST GUN MATERIEL  
GUN MK. II M1; BARBETTE CARRIAGE M4



- |  |  |                    |
|--|--|--------------------|
| <p>A—RIGHT ELEVATING GEAR<br/>PLATE D42605</p> <p>B—RIGHT SIDE FRAME D42549A</p> <p>C—(ELEVATING RACK BRACKET)<br/>BOLT A1488 AND<br/>NUT BBAX3D</p> <p>D—(ELEVATING RACK) BOLT<br/>B637 AND NUT BBAX3D</p> <p>E—RIGHT ELEVATING RACK<br/>BRACKET D42365A</p> <p>F—(ELEVATING RACK BRACKET)<br/>BOLT B639 AND<br/>NUT BBAX3D</p> <p>G—COUNTER RECOIL ASSEMBLY<br/>D42398</p> <p>H—ELEVATION FOLLOW-UP<br/>CONTROL CAM B161969—SCREW<br/>BCBX4CG AND LOCKING<br/>WIRE BFWX1B</p> <p>J—(BUFFER STOP) BOLT B162404 AND NUT BBAX3D</p> | <p>K—RIGHT ELEVATION BUFFER<br/>STOP B162386A</p> <p>L—RIGHT ELEVATING RACK<br/>D42316A (FOR CARRIAGE NO. 29<br/>AND UP—REPLACEMENT FOR<br/>CARRIAGE NO. 19 TO 28<br/>INCLUSIVE)</p> <p>M—RECUPERATOR CYLINDER<br/>DRAIN VALVE ASSEMBLY<br/>A218117</p> <p>N—(RECOIL CYLINDER FILLING<br/>FUNNEL) RETAINER A218470</p> <p>P—LOADING POSITION POINTER<br/>C3018—SCREW BCAX1ED<br/>AND WASHER BECX3M</p> <p>Q—(GEAR PLATE) BOLT B163021</p> <p>R—(GEAR PLATE) BOLT B162988B<br/>AND NUT BBAX3C</p> | <p>RA PD 38756</p> |
|--|--|--------------------|

Figure 73—Elevating Rack—Follow-up Control Cam and Loading  
Position Pointer

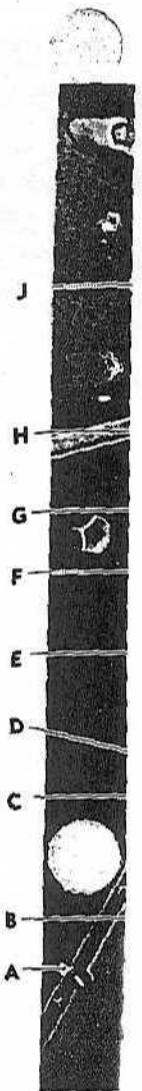

- |  |
|--|
| <p>A—OIL<br/>PLUG</p> <p>B—RIGHT<br/>ASS</p> <p>C—OIL<br/>PLUG</p> <p>D—OIL<br/>PLUG</p> <p>E—ELEV<br/>C54E</p> <p>F—ELEV<br/>AND<br/>LEVI</p> <p>G—CLU<br/>AND</p> <p>H—LAW<br/>B16</p> <p>J—ELE<br/>DRI<br/>B18<br/>BEC</p> <p>K—DIF</p> |
|--|

Figure 7

DESCRIPTION AND FUNCTIONING

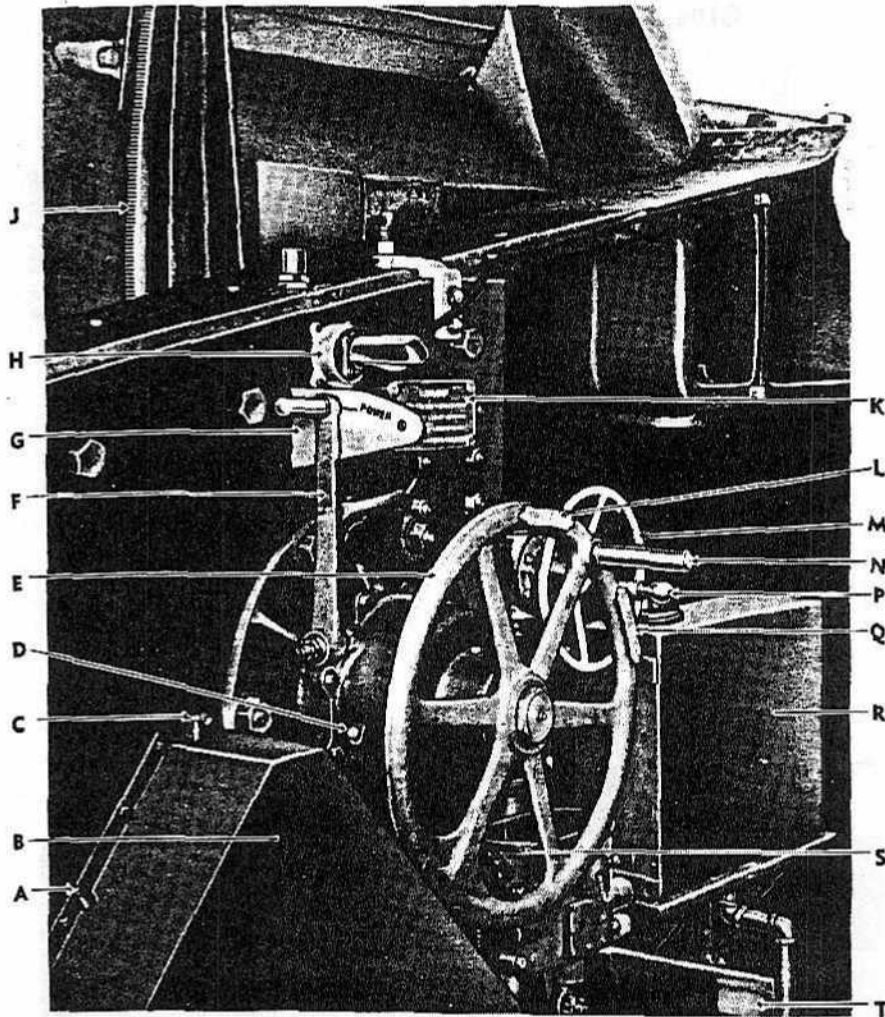
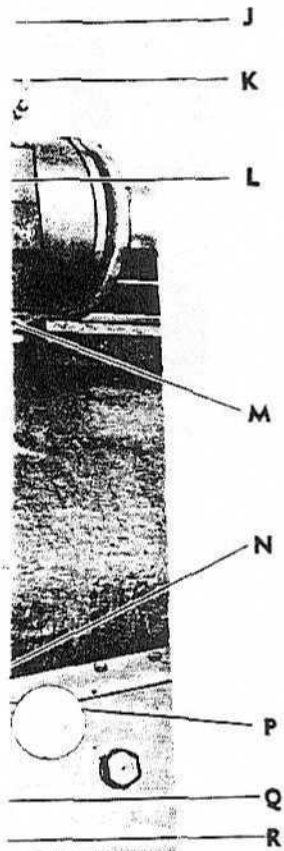

VATION BUFFER  
386A  
VATING RACK  
FOR CARRIAGE NO. 29  
REPLACEMENT FOR  
NO. 19 TO 28  
)  
TOR CYLINDER  
LVE ASSEMBLY  
  
Y.INDER FILLING  
RETAINER A218470  
POSITION POINTER  
REW BCAX1ED  
HER BECX3M  
ATE) BOLT B163021  
ATE) BOLT B162988B  
BBAX3C

RA PD 38756

C ind Loading

- A—OIL PIPE A149829 AND PLUG A8053
- B—RIGHT GEAR GUARD (ASSEMBLY) D42644
- C—OIL PIPE A149442 AND PLUG A8053
- D—OIL PIPE A149826B AND PLUG A8054
- E—ELEVATING HANDWHEEL C54863
- F—ELEVATING HANDWHEEL AND POWER DRIVE CLUTCH LEVER (ASSEMBLY) B162975
- G—CLUTCH LEVER ARC C54866 AND SCREW BCAX2BC
- H—LAMP RECEPTACLE BOX B162529
- J—ELEVATION DATA INDICATOR DRIVE RACK D42314—SCREW B187350A AND B AND WASHER BECX1T
- K—DIRECTION PLATE B126216 SCREW BCKX4EQ AND SPACER A149919
- L—ELEVATION DIRECTION PLATE A149809 AND SCREW BCKX4CF
- M—ELEVATING CONTROL HANDWHEEL C54804
- N—HANDWHEEL HANDLE (ASSEMBLY) B162992 WITH NUT BBGX2C—PIN BFAX1EK AND WASHER BEBX1R
- P—CONTROL HANDWHEEL HANDLE (ASSEMBLY) B162919
- Q—DEPRESSION DIRECTION PLATE A149810 AND SCREW BCKX4CF
- R—ELEVATING SPEED GEAR OIL EXPANSION TANK D42637
- S—ELEVATION DATA INDICATOR M5 D43205
- T—FOLLOW-UP CONTROL SHAFT STOP CLUTCH RELEASE LEVER B163006

RA PD 38757

Figure 74—Elevating Handwheels—Indicator Rack and Clutch Lever

**16-INCH SEACOAST GUN MATERIEL  
GUN MK. II M1; BARBETTE CARRIAGE M4**

- A—VERTICAL POWER DRIVE SHAFT B163004
- B—VERTICAL SHAFT BUSHING (RIGHT HALF) B163000A (LEFT HALF) B163000B
- C—(VERTICAL SHAFT) NUT A149837 WITH PIN BFAX2BC WASHER BEBX1W
- D—(CLUTCH FORK SHAFT) NUT BBGX2C WASHER A149820 PIN BFAX1EK AND KEY BGHX1QG
- E—CLUTCH FORK (ASSEMBLY) C54865
- F—OIL PIPE A149826A AND OIL PLUG A8054
- G—PEEP HOLE COVER A149803 AND RIVET BMCX1
- H—GEAR CASE D42539
- J—GEAR CASE STUD (ASSEMBLY) A149784 AND NUT BBAX3A (CONTINUED ON OPPOSITE PAGE)

RA PD 38760

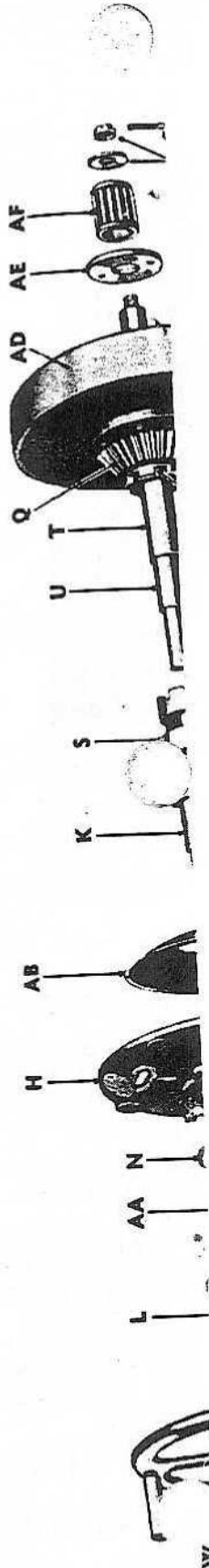
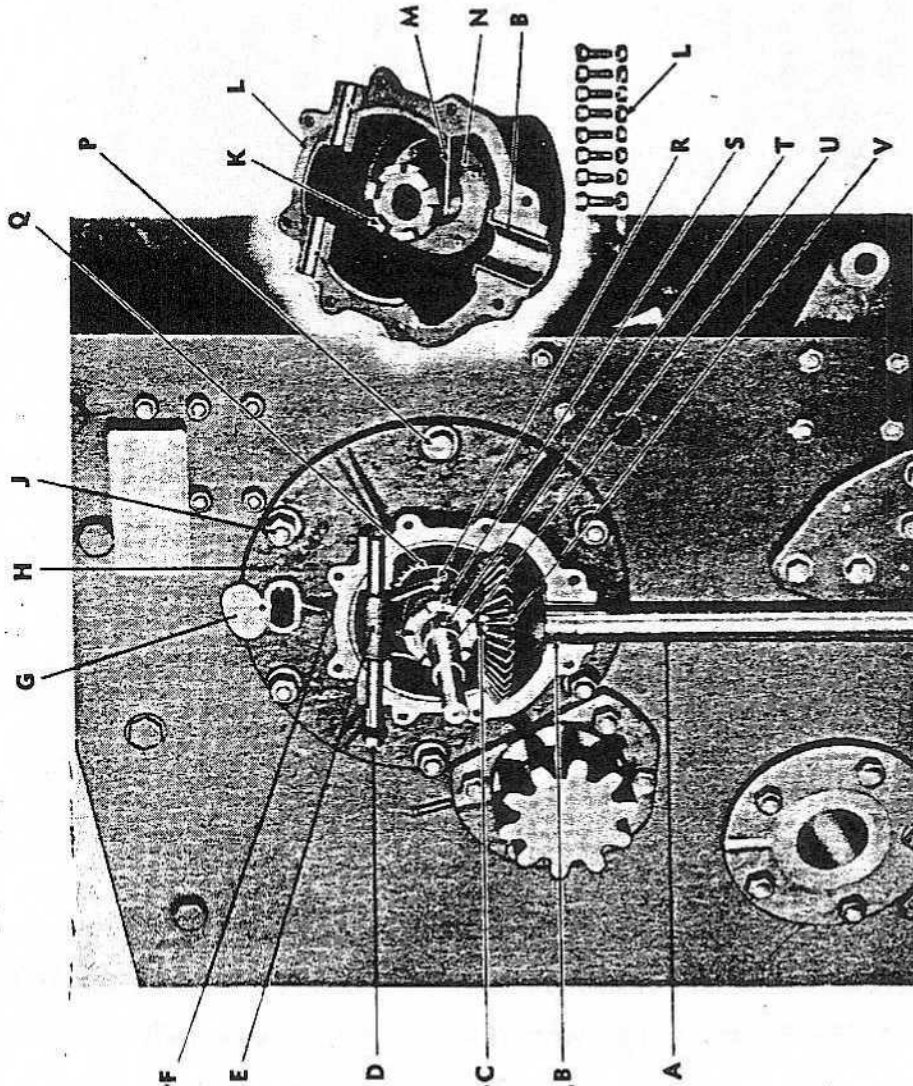

**Figure 75—Elevating Power and Handwheel Clutch—Exposed View**

Figure 75—Elevating Power and Handwheel Clutch—Exposed View

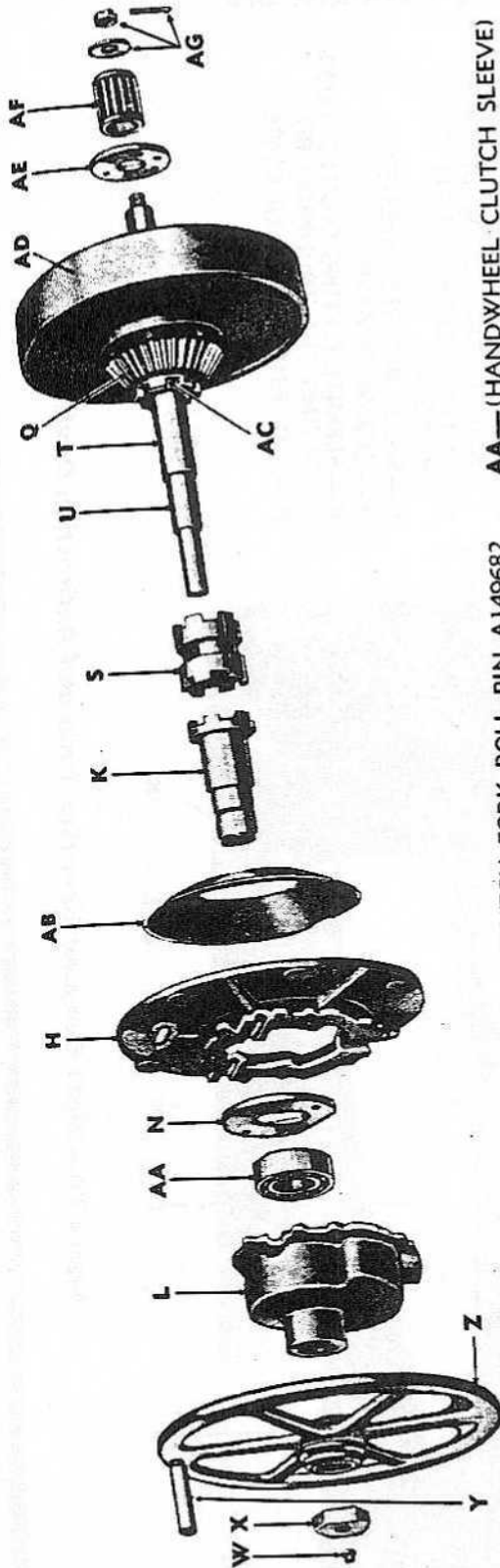

- (ITEMS A TO J LISTED ON PRECEDING PAGE)
- K—HANDWHEEL CLUTCH SLEEVE B162995—BUSHING A149816—PIN BFDX6FK AND BUSHING A149819
  - L—GEAR CASE COVER D42540—SCREW BCAX2AE AND NUT BBAX2B
  - M—OIL PIPE A149826B AND OIL PLUG A8054
  - N—BALL BEARING RETAINER A149815 WITH SCREW BCAX1CC
  - P—(GEAR CASE) SCREW BCAX2EG
  - Q—CLUTCH GEAR C54869 WITH BUSHING A149814 AND PIN BFDX6FR
  - R—CLUTCH FORK ROLL PIN A149682
  - S—ROLL A149683 AND NUT BBCX1E
  - S—ELEVATING POWER AND HANDWHEEL CLUTCH B162996
  - T—HANDWHEEL PINION SHAFT KEY A149795 WITH SCREW BCDX2AB
  - U—HANDWHEEL PINION SHAFT C54858
  - V—VERTICAL POWER DRIVE SHAFT BEVEL GEAR B163002
  - W—OIL CUP A149812
  - X—HANDWHEEL CLUTCH SLEEVE NUT A149811
  - Y—HANDLE (ASSEMBLY) B162992—NUT BBGX2C AND COTTER PIN BFAX1EK
  - Z—ELEVATING HANDWHEEL C54863
  - AA—(HANDWHEEL CLUTCH SLEEVE) BEARING CABX1AR
  - AB—BRAKE DRUM GUARD B163001 AND SCREW BCAX3A
  - AC—CLUTCH GEAR COLLAR A149817
  - AD—BRAKE DRUM B162991—SCREW A149798—NUT BBGX2B AND COTTER PIN BFAX1DK
  - AE—THRUST BEARING A149799 WITH SCREW BCKX4CF
  - AF—PINION SHAFT BEARING A149796
  - AG—PINION SHAFT NUT A149794—WASHER A149818 AND COTTER PIN BFAX2AC

DESCRIPTION AND FUNCTIONING

RA PD 38759

Figure 75-1—Elevating Power and Handwheel Clutch—Exploded View

**16-INCH SEACOAST GUN MATERIEL  
GUN MK. II M1; BARBETTE CARRIAGE M4**

- A—BELLEVILLE SPRING ROD C54965
- B—SPRING ROD LOCK NUT A149992
- C—SPRING ROD COLLAR NUT A149990
- D—BELLEVILLE SPRING B163094
- E—ALEMITE FITTING CLDX1B (LUBRICATING THE TRUNNION ANTI-FRICTION ROLLER BEARING)
- F—TRUNNION ROLLER BEARING PIN C87218
- G—RIGHT TRUNNION EXTENSION D49031A
- H—MAGNETO PLUG B160200
- J—TRUNNION ELEVATION POINTER A218057 AND SCREW BCFX4DD
- K—ANTI-FRICTION CRUTCH SPOOL A149858
- L—SPOOL BED STEP B163153
- M—SCREW - BCAX2BC
- N—ALEMITE FITTING CLDX1C (LUBRICATING THE TRUNNION BED)
- P—ANTI-FRICTION LEVER C54966

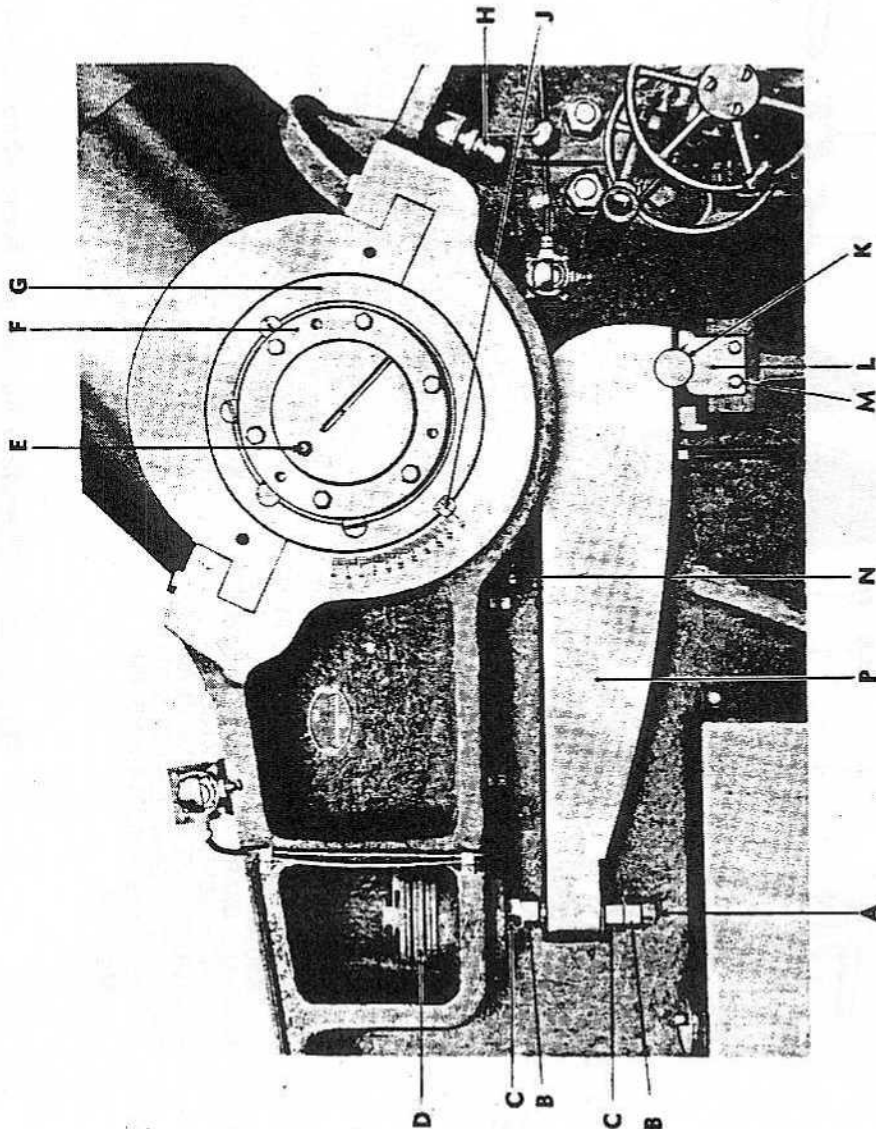

RA PD 38761

**Figure 76—Right Trunnion Elevating Scale and Antifriction Device**

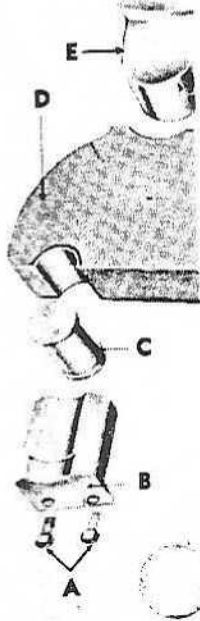

**Figure 78-**

## OPERATION

automatically when the operator stops turning the control handwheel.

(6) **CAM TRIPPING DEVICE.** When the gun is being elevated by motor power and the approximate limit of elevation or depression is reached, cams (X, fig. 87, and H, fig. 72) on the right elevating rack near its upper and lower ends engage with a cam lever (T, fig. 72) on the inside of the right side frame.

(a) This device, consisting of a series of cranks, levers, rods and springs, acts to engage clutches (fig. 68, and N, fig. 69) located on the control handwheel shaft and to prevent further elevation or depression of the gun.

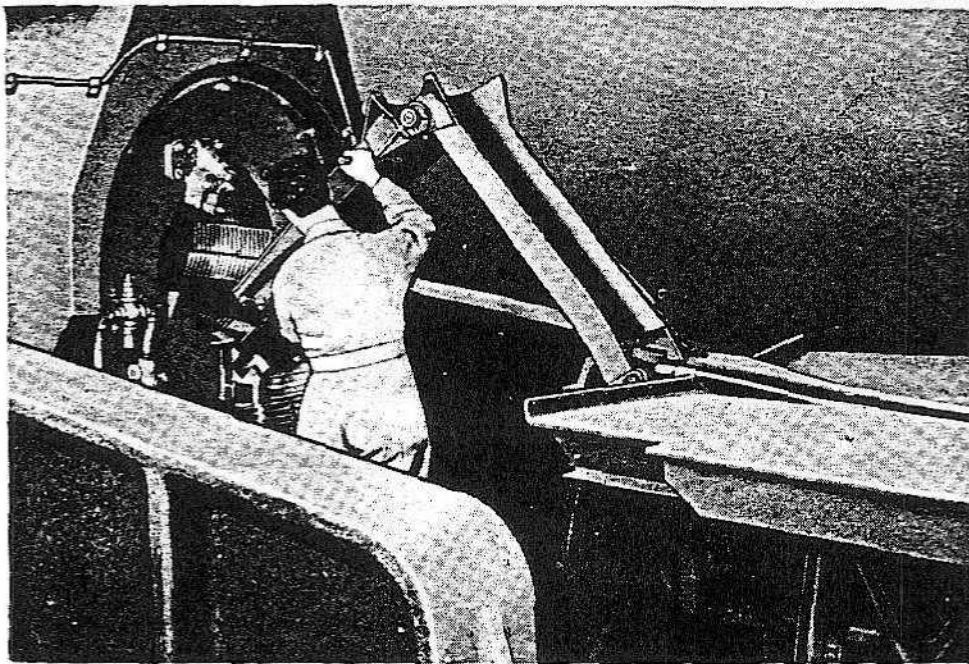

RA PD 38802

**Figure 144—Extending Loading Trough into Breech Opening**

(b) When these clutches are in engagement it is not possible to continue movement of the control handwheel in the direction in which the gun has been moving. Operation of the handwheel will then be possible only in the opposite direction.

(7) **CLUTCH RELEASE.** To facilitate release of the clutches employed to stop the elevating gearing at extremes of elevation and depression, a knee operated lever (T, fig. 74) is provided which enables the operator to throw the clutches out of engagement in the event of inability to easily release the mechanism by reversing the movement of the control handwheel. When the clutches are released the gun may be elevated or depressed, by power, slightly beyond the position determined by the automatic action of the cams and cam levers.

### j. Traversing the Mount by Hand.

(1) **TRAVERSING CRANKS.** With the traversing clutch shifter handle



**16-INCH SEACOAST GUN MATERIEL  
GUN MK. II M1; BARBETTE CARRIAGE M4**

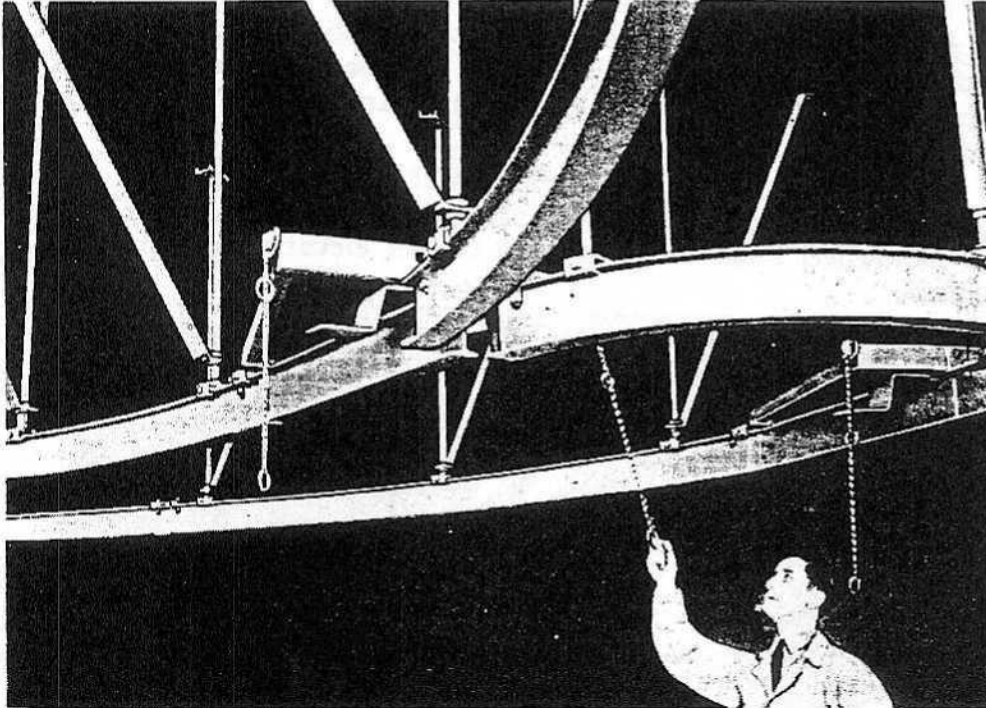

RA PD 38803A

**Figure 145—Operating Switch in Overhead Trolley**

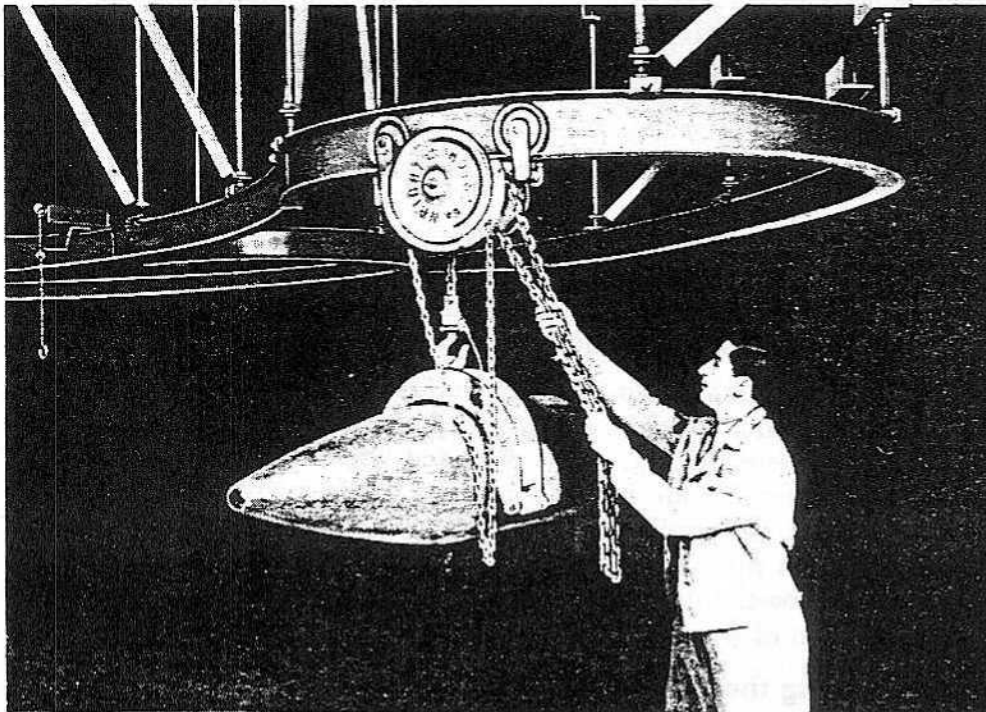

RA PD 38803

**Figure 145-1—Hoist on Overhead Trolley with Dummy Projectile**

OPERATION

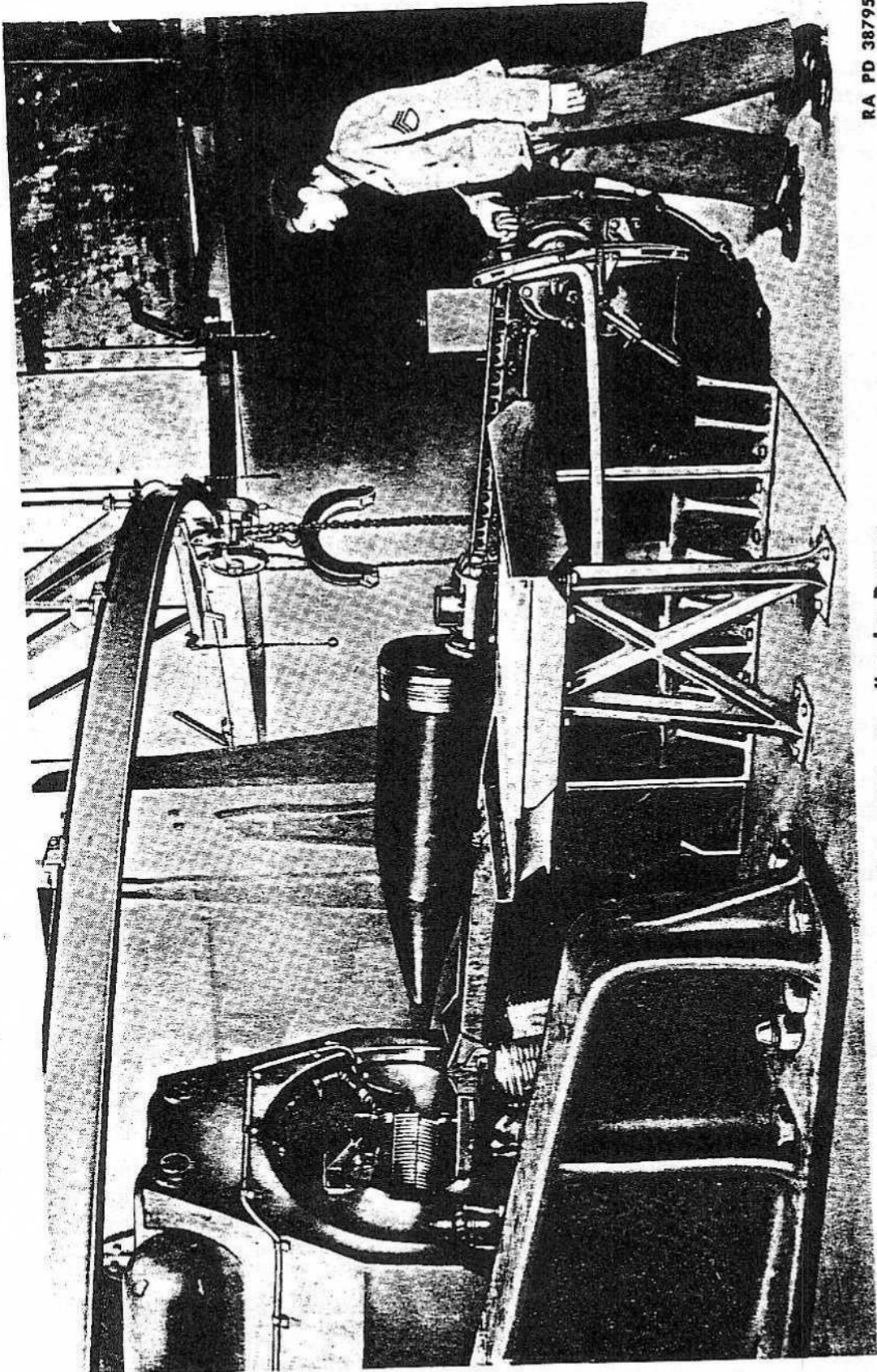

RA PD 38795

Figure 146—Loading by Power

**16-INCH SEACOAST GUN MATERIEL  
GUN MK. II M1; BARBETTE CARRIAGE M4**

(fig. 138, and L, fig. 93) on the left side frame at "HAND" position, assemble the traversing cranks (fig. 139, and F, fig. 94) on the crankshafts (G, fig. 94) and lock them in place with the split pins provided for the purpose. Traverse the mount to the right and left by means of the cranks and note that the mount traverses freely. Rotate the mount to its extreme right and left position within prescribed limits. The mount may be traversed 72.5 degrees to the right and left of the center line of fire.

(a) Before attempting to traverse the mount by either hand or electric power, the traversing multi-disk friction device must be set with proper friction on the slipping parts to prevent injury to the traversing mechanism. This adjustment will be made only under the supervision of trained Ordnance Department personnel (fig. 141).

(2) **LIMITS OF TRAVERSE.** Care must be exercised when approaching the limits of traverse to slow down the movement of the rotating mass. The following precautions must be observed:

(a) The carriage should never be traversed *manually* so as to come into contact with the positive stop under full power.

(b) The limit switch button and the start button at the traversing push-button station (fig. 156), or the manual reset lever at the motor controller, should not be operated unless the speed gear control indicator dial (C, fig. 103, and R, fig. 96) is set at zero.

(c) When the gun is to be traversed beyond the azimuth limits of the electric limit stop, the carriage should be rotated manually unless care is taken to use the least possible speed gear stroke that will move the carriage in azimuth.

(3) **SLOW-MOTION HANDWHEELS.** Manipulate the slow-motion traversing handwheels (fig. 140, J, fig. 93, and U, fig. 95) on the right and left sides of the mount to ascertain that the slow-motion train of gearing is in proper working condition.

(4) **TRAVERSING CLUTCH SHIFTER.** Operate the traversing clutch shifter lever (fig. 138, and N, fig. 94), located on the left side frame, to see that it moves the traversing clutch in and out of engagement without interference. If necessary, rotate the slow-motion handwheel, after pressing down the foot treadle (fig. 140), to bring the teeth of the engaging parts into proper alinement.

(5) **FOOT TREADLES.** Test the operation of the slow-motion foot treadles (M, fig. 99) to insure that the treadle counterweights (L, fig. 99) will return the treadles to the "UP" position when released, and that the treadle latch plate (N, fig. 99) will hold the treadle in "DOWN" position until kicked loose by the operator.

(6) **TRAVERSING CONTROL INDICATOR.** With electric current to the traversing motor *shut off*, test the traversing indicator control parts by maneuvering the traversing control handwheels in the operator's cab (T, fig. 94) at the left slow-motion handwheel to insure free operation

## OPERATION

of the mechanism. This test will be made *only* after the operator is assured that the traversing motor is *not* running.

**k. Traversing by Electric Power.** Traverse the mount within prescribed limits by electric power to insure that all working parts operate properly. The following sequence of operations will be observed:

(1) Check *all* push-button stations to insure that the switches are open by testing the spring return action of the switches at start and stop positions.

(2) Note that the handles on all motor controllers are at "OFF" position and that the traversing indicator dials are at zero position on the traversing control gear case.

(3) Remove caps (J, fig. 150) from the power cable loop receptacles (A, fig. 149, and E, fig. 150) at the recess in the emplacement and on the inclined surface of the racer and assemble the loop cable in place.

(4) Attach the plug retaining nuts (D, fig. 150) on the cable to the receptacles on the racer and emplacement.

(5) Assemble supporting chains (F, fig. 149, and Q, fig. 150) to the brackets (D, fig. 149, and M, fig. 150) on the racer and emplacement. Note that the supporting chain located nearest to the receptacle on the cable must be assembled to the chain bracket on the racer.

(6) In order to traverse the mount by "POWER" the traversing clutch shifter lever (fig. 138, and N, fig. 94) must be set at "POWER" position and the control switch at the traversing push-button station (fig. 156) must be pressed in to start the motor. The traversing control indicator **MUST** show that the traversing control detent is in neutral position before the push button at the control station is used to start the motor. Failure to provide for this sequence of operations will result in an overload on the motor.

(7) Speed and direction of traverse is controlled by means of the traversing control handwheel (fig. 142, and T, fig. 94) located beneath the left slow-motion handwheel (J, fig. 93), and also by the control handwheel (D, fig. 103) and (fig. 143) in the operator's cab.

(8) The direction of traverse is determined by manipulating the control handwheels in the direction indicated by the arrows on the indicator dials (Q, fig. 93, and C, fig. 103).

(9) **TRAVERSING LIMIT SWITCH.** The limit switch button at the traversing control push-button station (fig. 156) is *designed to reestablish* operation of the motor when it is automatically shut off by contact of the traversing limit switch (M, fig. 104) connected to the racer, with the limit switch stop rail (B, fig. 104) attached to the base ring. To reestablish electrical contact the limit switch button at the traversing push-button station must be pressed in and *held* in that position until the mount is traversed to a point where there is no longer contact between the wheel on the control switch and the limit switch stop rail. In order to activate the motor the starting button must be pushed while the limit switch button is *held* in operating position.

**16-INCH SEACOAST GUN MATERIEL  
GUN MK. II M1; BARBETTE CARRIAGE M4**

(a) Before pressing the limit switch button and the starting button which activates the motor, be sure that the position arrow on the traversing control gear case points to zero graduation on the dial indicator. With the motor running, the mount may now be traversed to the right or left, as required by operating the control handwheel either under the left slow-motion handwheel or in the observer's cab.

(b) If it is desired to continue rotation in the same direction beyond the point where the limit switch device has shut off the electrical power, it will be advisable to continue this movement by hand power using slow-motion handwheel to bring the gun to further right or left position as may be desired. (See Limits of Traverse, par. 9 j (2).)

(c) If it is desired to reverse the movement of the rotating parts, electric power may be used and the direction of movement will be controlled by manipulation of the traversing control handwheel. If hand power is to be used at any time to traverse the rotating parts, the clutch shift lever on the left side frame must be set at "HAND" position.

(10) TRAVERSING DATA RECEIVER. Observe the action of the mechanical traversing dial on the data receiver (K, fig. 94) while the mount is being traversed to insure that the dial moves smoothly. If there is any indication of malfunction of this device, the matter must be called to the attention of Ordnance Department personnel for correction. No adjustment of this device will be undertaken by the using service.

**10. OPERATION OF THE RAMMER.**

a. To load the piece, set the gun at 3 degrees, 48 minutes elevation. This angle will be indicated by the loading pointer (P, fig. 73) located on the right side frame which must be set to agree with the loading angle marking on the right elevating rack (L, fig. 73).

(1) Open the breechblock. Lower the block carefully to full lowered position (fig. 10). When gases and debris have been ejected close the gas ejector valve (fig. 25, and R, fig. 13) to avoid drain on the air compressor system.

(2) Lower the loading trough (fig. 144) and insert the forward end in the breech recess of the gun.

(3) Using either an ammunition truck or overhead trolley and shot tongs (fig. 146), place projectile in the rammer trough (fig. 147). (Practice projectile shown.)

**b. Loading Projectile by Motor Power.**

(1) REMOVE THE HAND OPERATING CRANKS (P, fig. 109) if assembled.

(2) Pin the clutch lever in the outer hole of the lever locking device (fig. 148).

### OPERATION

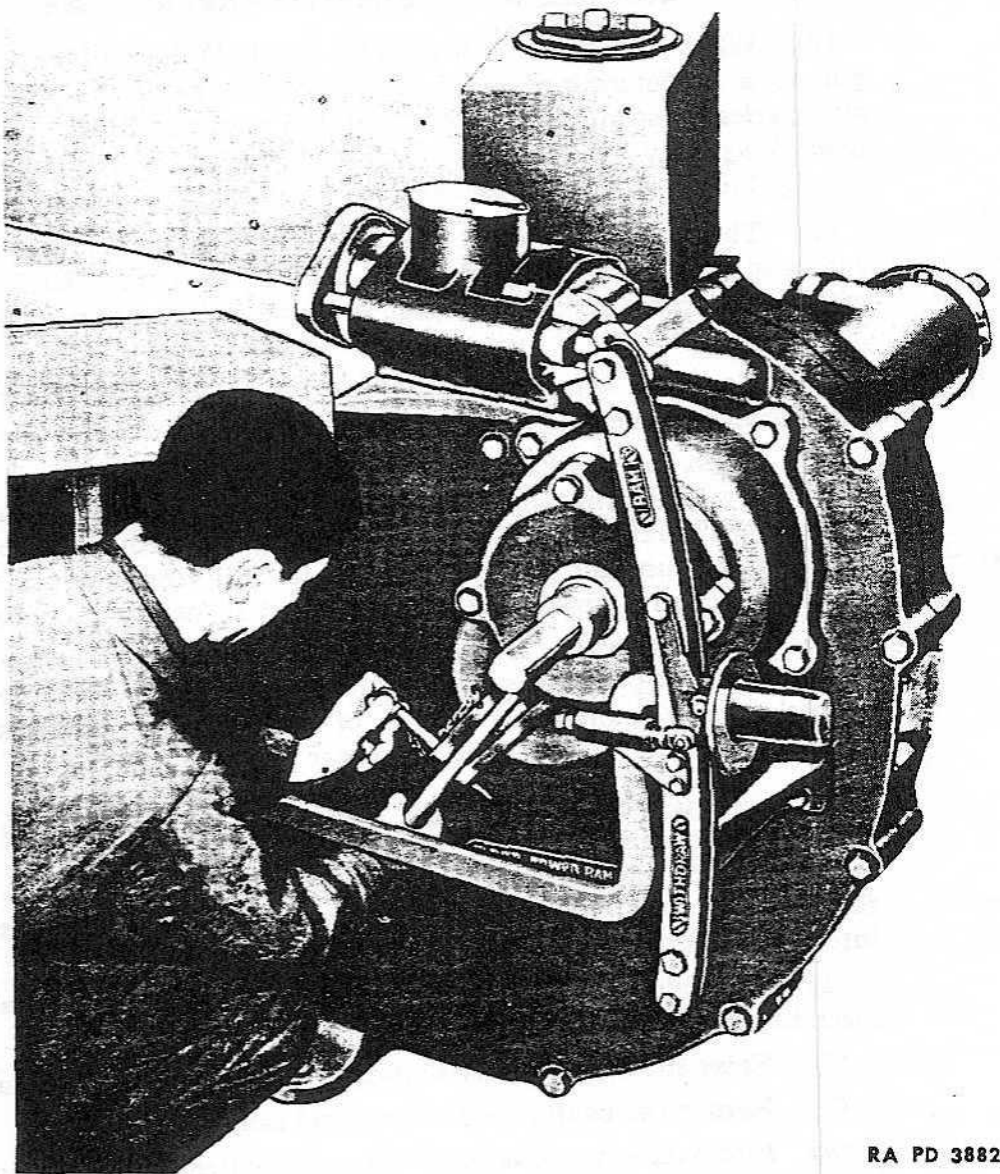

RA PD 38828

**Figure 147—Engaging Power Clutch of Rammer**

(3) Move the control lever (Q, fig. 109) to neutral position on the operating lever sector.

(4) Press the "START" button at the rammer push-button station (fig. 157) located near the rear end of the right side frame. This activates the rammer motor (fig. 110, and T, fig. 151) which should be allowed to run to full speed before attempting to ram the projectile.

(5) To ram the projectile into the gun raise the control lever from neutral to "RAM" position (fig. 148).

(a) The time required for ramming the projectile should not exceed five seconds.

**16-INCH SEACOAST GUN MATERIEL  
GUN MK. II M1; BARBETTE CARRIAGE M4**

(b) When the rammer head (D, fig. 107) has advanced into the gun to a predetermined point an unstroking device (P, fig. 110) will automatically stop further travel of the rammer head. The point of unstroking may be varied by adjusting the zero adjusting coupling (L, fig. 110) in the drive mechanism.

(c) The operation of the unstroking device in stopping the speed gear also acts to disengage the control lever from the "RAM" position with considerable force, returning it to neutral position in the control lever sector.

(d) To avoid injury the operator must remove his hand immediately from the lever when it reaches the "RAM" position.

(e) When the forward movement of the rammer head has been stopped by the unstroking device, move the control lever to the position marked "WITHDRAW" (N, fig. 109) on the control lever sector. This action will return the rammer head to its full rearward position, after which the control lever should be returned to neutral position.

(f) Before inserting powder charge in the chamber be assured that the projectile is properly seated in the gun tube. If it has failed to seat properly, hand ramming by means of hand rammer on rammer stave may be employed to drive it to its proper position.

**c. Loading Powder by Motor Power.** After ramming the projectile and with the rammer head (D, fig. 107) fully withdrawn, assemble three of the six powder bags required for a service charge end to end in the rammer trough, raise the control lever gradually and move the bags into position in the powder chamber.

(1) Now move the control lever to "WITHDRAW" position and assemble the remaining bags of powder in the rammer trough.

(2) Raise the control lever and complete the loading operation.

(3) Return the control lever to neutral position.

(a) Alternative procedure. If there is evidence of buckling of the bags when assembled in groups of three and it is deemed to be more advantageous, two bags may be assembled end to end and rammed into the powder chamber in each operation.

(4) Raise the loading trough to folded position (fig. 107).

(5) Close the breechblock by closing the gas ejector valve (R, fig. 13) if open, and opening the closing valve (Y, fig. 13) gradually to avoid too rapid closing of the block. Note instructions in paragraph 9 b (5).

**d. Loading by Hand Power.** Proceed in the same manner as outlined for loading by motor power, with the following exceptions:

(1) Pin the clutch shift lever (S, fig. 109) in the inner hole of the lever locking device (figs. 147 and 148). This arrangement disconnects the gearing from the rammer motor. Direct drive from the crankshaft to the rammer chain sprocket is provided.

### OPERATION

(2) Assemble the hand cranks to the crankshaft (A, fig. 109) and place the control lever in neutral position.

(3) To avoid interference with operation of the hand rammer remove the mechanical rammer head (fig. 111) from the rammer chain (fig. 146). Disconnecting the rammer head from the rammer chain is accomplished by opening the locking snap ring (B, fig. 111) on the pin (A, fig. 111) connecting the rammer head to the chain, and then removing the pin.

(4) Ramming the projectile by hand power is accomplished by contacting the hand rammer with the base of the projectile and driving the projectile forward with all possible speed, using as many men as may be required to insure rapid movement of the projectile to its proper seat in the gun tube.

(5) The powder charge will be rammed into the powder chamber using such number of bags in each ramming operation as will provide the most expeditious handling of the charge.

**CAUTION:** Before firing the piece *disconnect* the cradle and recoiling parts lock (fig. 130) from the cradle and recoil band.

**NOTE:** Operation of the electrical equipment is outlined in section VIII.



**16-INCH SEACOAST GUN MATERIEL  
GUN MK. II M1; BARBETTE CARRIAGE M4**

**Section IV**

**CARE AND PRESERVATION**

	Paragraph
General .....	11
Care of the gun .....	12
Care of the carriage .....	13
Care of the rammer .....	14
Care of stuffing boxes.....	15
Filling devices .....	16
Filling hydraulic speed gears with oil.....	17
Air compressor .....	18
Lubrication instructions .....	19

**11. GENERAL.**

a. The accuracy life of the gun and serviceability of the gun and carriage depend largely upon the care exercised in keeping the parts clean and properly lubricated.

b. This section contains brief instructions for proper care and lubrication of the parts.

**12. CARE OF THE GUN.**

a. As the accuracy life of cannon is decreased by a fast rate of firing, attendant heat and improper cleaning after firing, the piece should be cleaned, oiled and allowed to cool as often as practicable.

(1) In cleaning after firing, wash the bore with a solution made by dissolving one-half pound of SODA ASH or one pound of sal soda in one gallon of water, using sponge for swabbing purposes. Wipe the surface until thoroughly dry, using a sponge covered with burlap, then oil the bore with a light coating of COMPOUND, rust preventive. This should be applied with the slush brush provided as an accessory for the gun.

(2) The breech and muzzle of the gun should be kept covered to prevent dirt and grit from entering the bore and recesses of the breech mechanism. Covers for this purpose are supplied as a part of the accessories for the gun.

(3) The breech mechanism will be kept clean and the firing mechanism will be given special attention. When not in use the firing lock should be removed from the gun and stored in the firing lockbox. Both should be disassembled frequently and finished parts should be washed with SOLVENT, dry-cleaning, wiped dry, and lubricated in accordance with requirements outlined in the Lubrication Guide.

(a) Complete disassembly of the breech mechanism will be undertaken only under supervision of trained Ordnance Department personnel.

**CARE AND PRESERVATION**

(4) It is important that any cutting or abrasion of the breechblock, breechblock liner or other operating parts of the breech or firing mechanism be reported to the ordnance maintenance company for correction.

(5) If the breechblock does not operate smoothly or if greater than usual effort is required to maneuver the parts of the breech mechanism, a check of the conditions will be made and corrective action taken.

(6) In assembling or disassembling any of the parts of the breech mechanism, do not use a steel hammer directly on any part. A copper plate, drift, or copper hammer should be employed, where necessary, in order to prevent deformation of the parts.

(7) It is important that the cannoneer examine the condition of the bore and powder chamber after each firing to insure that the gas ejector has removed all particles of unburned powder, powder bags or other foreign matter from the gun.

(8) Should enemy shell burst near the weapon, be assured before further firing that no damage has occurred that would endanger the materiel or personnel. Damage of a serious nature should be reported at once to the ordnance officer in charge.

(9) When the piece is to remain inactive for a considerable length of time, the gun bore, breech mechanism and all unpainted parts of the gun will be cleaned with SOLVENT, dry-cleaning, and the surfaces coated with COMPOUND, rust preventive.

(10) The salvo latch on the gun breech is provided with a buffer cylinder containing a plunger, spring and packing. This device should be examined frequently to see if there is evidence of leakage at this point. If leakage is noted, the plunger packing gland should be tightened. If leakage continues, remove the gland and insert new packing.

(11) The carrier buffer attached to the rear end of the recoil cylinder piston rod is provided with a hydraulic cylinder containing a piston plunger, spring and a hydraulic packing which is enclosed in the cylinder head.

(a) This device should be checked for leakage at frequent intervals. If there is evidence of leakage, the packing gland should be tightened using the spanner wrench provided for the purpose.

(b) If leakage continues, remove the packing gland and insert new packing.

(c) Refill the cylinder with liquid by removing the expansion chamber which also serves as a filling hole plug.

(12) **AIR PIPE LINE.** The air compressor pipe line leading from the air compressor to the gun breech is provided with an expansion joint which is attached to the left side of the cradle body and the recoil band. This device operates during recoil and counterrecoil of the gun to provide a continuous flow of air to the gas ejector valve and breech closing cylinders. The device consists of an inner tube and an outer tube operated by telescopic action. Escape of the compressed air is prevented by means of 1/4-inch square hydraulic packing enclosed in a stuffing box and held in place by a packing gland.

**16-INCH SEACOAST GUN MATERIEL  
GUN MK. II M1; BARBETTE CARRIAGE M4**

(a) If there is evidence of escaping air at the stuffing box the gland should be tightened. If air continues to escape notify Ordnance Department personnel who will remove the packing gland, insert new packing and reassemble the gland.

**PRECAUTION:** Before removing the gland the air compressor motor must be *stopped* and all valves leading from the air compressor motor to the air storage tanks and from the storage tanks to the main air line must be closed. The gas ejector valve on the gun breech must be opened to allow the accumulated compressed air in the pipe line to escape until only atmospheric pressure is indicated. When the air compressor is in operation the air pressure will register up to 155 pounds per square inch. Never remove the packing gland or packing before the compressed air is *shut off* and the pressure dissipated. Disassembly and assembly of the expansion joint will be done only by experienced ordnance personnel.

(b) Make frequent examination of all joints in the air pipe line, and be assured that air is not escaping at any point. If there is evidence of escaping air the matter should be brought to the attention of the ordnance personnel for corrective action, as in most cases it will be necessary to disassemble the line to overcome the difficulty.

**13. CARE OF THE CARRIAGE.**

a. All parts of the carriage must be kept clean and free from rust, dirt, or other foreign matter.

(1) All bearing surfaces, revolving parts, sliding parts, gears, bearings, rollers, pintle surfaces and roller paths shall be kept thoroughly lubricated.

(2) The subject of lubrication, with the method and frequency of application to be employed, is covered in paragraph 19 f (Lubrication Guide).

(3) Only cleaning and preserving material as issued by the Ordnance Department will be used in the care and maintenance of the carriage.

(4) Frequent examination of the carriage materiel will be made to insure its serviceability. If any loose, broken, or distorted parts are found, immediate steps will be taken to repair or replace them.

(5) When the mount is to remain unused for a considerable length of time, all finished unpainted surfaces will be protected with a coat of medium COMPOUND, rust preventive. Before applying the compound, the surfaces will be cleaned with SOLVENT, dry-cleaning.

(6) Removable gear case covers will be disassembled at frequent intervals in order to note the condition of the moving parts. If rust or dirt has accumulated, the parts will be cleaned and put in serviceable condition. The use of coarse abrasives in removing rust or other foreign substances is prohibited. Fine emery cloth not coarser than 00 grade may be employed in removing rust spots from the finished materiel.

(7) Traversing rollers and roller paths must be kept clean and free

## CARE AND PRESERVATION

from rust and grit in order to insure easy operation of the traversing parts.

(a) The racer is provided with cover plates assembled in each segment which may be removed in order to examine and clean the traversing rollers and roller path surfaces.

(b) To facilitate the work of cleaning the parts, the traversing rollers are assembled with removable journal bearings, in the distance ring, and they may be removed through the openings in the racer. Lifting hooks which are carried as accessories are provided for this operation.

(c) Extreme care must be exercised in replacing covers to insure that they are properly in place and securely fastened to prevent dirt or moisture from reaching the rollers and roller paths.

### 14. CARE OF THE RAMMER.

a. The rammer is provided with a hydraulic cylinder located in the rammer head which should be examined frequently for evidence of leakage. As the hydraulic packing and packing gland are enclosed within the cylinder and their adjustment requires disassembly and the use of special tools, evidence of leakage will be reported to ordnance personnel for correction.

b. The rammer chain, chain sprocket, and other moving parts of the mechanism will be kept clean and thoroughly lubricated during the time that the rammer is in service. When the rammer is to remain idle for a considerable period of time the finished parts will be protected by a coating of COMPOUND, rust preventive.

### 15. CARE OF STUFFING BOXES.

a. In order that the recoil and recuperator mechanisms, rammer head and other hydraulic devices function properly, it is important that stuffing box glands be assembled with sufficient pressure on the gland packings to insure that there is no leakage of liquid from the cylinders.

(1) *RECOIL CYLINDER.* Examine the stuffing box of the recoil cylinder. If there is evidence of leakage, set up the gland nut using spanner wrench provided with tool chest. This nut is provided with a right-hand square thread, three threads per inch. Care must be exercised to avoid setting the nut too tightly, thereby creating undue pressure on the packing rings and excessive friction on the piston rod. For instructions for filling the recoil cylinders see section III, paragraph 9 f.

(2) *RECUPERATOR CYLINDERS.* Check recuperator cylinders (figs. 50 and 51) for oil leaks which may occur at one or more of four points on the cylinder—i.e., between the front end of the cylinder (C, fig. 50) and cylinder gland (G, fig. 50), between gland (G, fig. 50) and gland (L, fig. 50), between the forward end of the plunger (AE, fig. 50) and plunger gland (AM, fig. 50), or between plunger gland (AM, fig. 50) and outer gland (AN, fig. 50).

(a) The above glands are assembled on studs screwed into the for-

**16-INCH SEACOAST GUN MATERIEL  
GUN MK. II M1; BARBETTE CARRIAGE M4**

ward ends of the main cylinder and plunger and are adjusted by means of nuts assembled on the studs.

(b) The inner and outer glands for the main cylinder are assembled on  $\frac{1}{8}$ -inch diameter studs, and the plunger glands are assembled on  $\frac{3}{4}$ -inch diameter studs. By means of this arrangement pressure on the leather packing rings and hydraulic packing may be applied at any point necessary by adjusting the proper set of stud nuts without affecting the condition of the cylinder at any other point.

(c) Should a leak develop at any of the locations above referred to, it may be overcome by tightening the appropriate set of nuts.

(d) Due to the fact that these glands are assembled on studs set in a circle, it is extremely important that care be exercised in obtaining even tension on each stud nut to insure equal pressure at all points on the leather rings and hydraulic packing.

(e) If leakage continues after tightening the gland stud nuts, the matter will be referred to the ordnance personnel for correction.

(f) Under no circumstance will the using service undertake disassembly of the parts of the recuperator cylinders.

(g) For instructions for filling recuperators with liquid, see section III, paragraph 9 e.

**16. FILLING DEVICES.**

a. **Recoil Cylinders.** For filling the recoil cylinder a filling funnel (G, fig. 48), which is carried in the armament chest, is attached to a bracket (E, fig. 48) on the right side of the cradle. A fitting on the lower end of the flexible tubing of the funnel is attached to the filling valve (fig. 48) which is located at the bottom and to the rear of the recoil cylinder. A plug cap (K, fig. 48) on tee (J, fig. 48) in the expansion chamber piping provides for venting of the recoil cylinder during the filling operation.

b. **Recuperator Cylinder.** A filling funnel (fig. 120) used for filling the recuperator cylinders with liquid is carried in the armament chest. When this funnel is used the oil flows into the recuperator cylinders by gravity and there must be neither liquid nor air pressure in the cylinders. The filling funnel is attached at the top of the liquid valves (fig. 54) after the filling cap (E, fig. 54) has been removed.

(1) A liquid pump (fig. 55) is mounted on the left side of the cradle and provides a means of replenishing the liquid in the recuperators after they have been charged.

(2) A compressed air cylinder tubing (fig. 116) used for filling the recuperators with air is carried with accessories for the carriage. This tube is coiled for mechanical flexibility and its ends are attached to the air maneuver valve (B, fig. 44) and (figs. 56 and 116) and to the portable compressed air cylinder.

## CARE AND PRESERVATION

### 17. FILLING HYDRAULIC SPEED GEARS WITH OIL.

a. Speed gears must be completely filled with air-free oil. The presence of air in the oil will prevent the proper functioning of the device. To insure freedom of air from the oil chamber, each motor speed gear is provided with an oil expansion reservoir which must be kept filled to one-half capacity at all times.

b. Examination of the oil level in the oil expansion reservoirs for the elevating, traversing and rammer speed gears will be made at frequent intervals. If the oil is found to be below the required level it will be replenished.

### 18. AIR COMPRESSOR.

a. **General.** The compressor is equipped with a crankcase (H, fig. 59) which is kept filled with oil to a level determined by the oil gage located in the oil well of the crankcase. A drain plug (R, fig. 58) is provided for draining the oil from the case. The compressor is also provided with a moisture trap and air filters (fig. 62, and B, fig. 58) which operate to care for condensation in the line leading to the pressure switch and magnetic unloader. The trap has a drain cock (fig. 62) at the bottom for drawing off accumulated moisture and is also provided with an air filter (fig. 62) at the top for filtering the air to the control system.

b. **Filter Elements.** The filter elements may be taken off for cleaning by removing the wing nuts (fig. 65). **CAUTION:** The filter element must be washed in light oil. The use of kerosene or gasoline is prohibited.

c. **Relay Valves.** Occasionally foreign matter accumulates in the unloading relay valves (fig. 63, and K and S, fig. 58) and under this condition the unloading system will not function properly. The valves may be cleared by pressing in the plunger of the magnetic unloader (fig. 128) in section III. This action releases the air in the unloading system and cleans the seats of the relay valves.

(1) The unloading system is provided with an oil priming cock (fig. 64) which is used to prime the relay valves when the valve seats are dry. Dryness of the valve seats causes failure of the unloading system to operate until the seats have been lubricated. The oil priming cock is provided with a dust cap which moves with the lever in opening the valve.

d. **Lubrication.** The compressor is equipped with a pressure system for lubrication. When the oil pressure gage (J, fig. 66) registers 35 it indicates proper lubrication of the compressor. An oil filter (fig. 67) insures a flow of clean oil to the compressor parts.

e. **Operation.** When the compressor is operated "CONTINUOUSLY" the unloading system holds the three compressor cylinder suction valves (fig. 65) open, thereby interrupting the pumping action while the compressor continues in motion. The unloading system releases the three compressor cylinder suction valves for normal operation when

**16-INCH SEACOAST GUN MATERIEL  
GUN MK. II M1; BARBETTE CARRIAGE M4**

the minimum allowable pressure is reached. This reestablishes the pumping action of the compressor.

(1) When the compressor is operated "AUTOMATICALLY" the pressure switch (fig. 61) opens the electric circuit as the minimum or maximum limits of pressure are reached, causing the motor to start or stop as required.

**f. Checking Oil in Air Compressor.**

(1) Each time the compressor is put into service the oil level must be checked before starting the compressor motor. The level cannot be

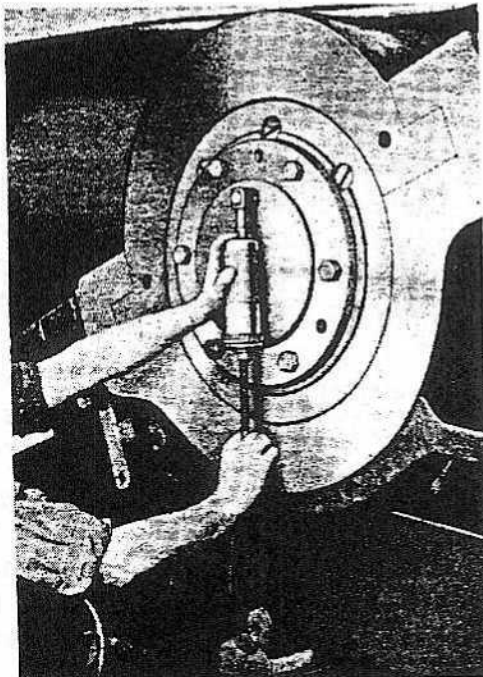

RA PD 38821

**Figure 148—Using Lubricating Gun on Fitting  
(For Trunnion Roller Bearing)**

checked after the motor is started because the operation of the oil pump causes splashing and fluctuation of the oil level in the reservoir.

(2) To check the oil level:

(a) Remove the oil gage and wipe it off with a clean rag.

(b) Reinsert the oil gage in the oil well and press down as far as possible.

(c) Remove the oil gage and observe to what extent the gage has been wet by oil. If the oil reaches the upper notch of the oil gage, the compressor has ample oil; but if the oil does not reach the lower notch of the gage, oil must be added.

**19. LUBRICATION INSTRUCTIONS.**

a. General. The following lubrication instructions for Gun, 16-in., Mark II, M1; Carriage, barbette, 16-in., M4, are published for the

## CARE AND PRESERVATION

information and guidance of all concerned, and supersede all previous instructions. Materiel must be lubricated in accordance with the latest instructions contained in Technical Manuals and/or Ordnance Field Service Bulletins.

b. Except when lubricants are used to protect metal surfaces from rust or corrosion, lubricants are always applied to metal surfaces that rub together. When even the tiniest particles of dust or grit get into the lubricant between these rubbing surfaces, scoring and extremely rapid wear occurs. For this reason cleanliness should be emphasized. Dirt should not be allowed to accumulate on the weapon. Where these rubbing surfaces are not closed off and lubricated by fittings or holes the lubricant should be thoroughly cleaned off and replaced with clean lubricant at the intervals given in the Guide following. Before removing plugs from holes and covers from fittings and before lubricating open holes, thoroughly clean the adjacent surfaces to prevent dirt from entering.

c. Lubricating fittings are painted red for ease in locating. Oilholes are encircled by red rings.

d. **Lubrication Guide.** Lubrication instructions for all points to be serviced by the using arm are shown in War Department Lubrication Guides Nos. 148-1, 148-2, 148-3 and 148-4, which specify the types of lubricants required and the intervals at which they are to be applied. The following lubrication instructions contain the same information as the guide. Guides from which data are reproduced are 10- x 15-inch laminated charts which are part of the accessory equipment of each piece of materiel. Data contained in the Lubrication Guides is taken from Technical Manuals, and are binding on using troops.

e. **Points to be Serviced and/or Lubricated by Ordnance Maintenance Personnel at Time of Ordnance Inspection.**

(1) **TRAVERSING GEAR CASES.** To remove accumulated sediment in the gear cases, the units will be disassembled once a year, and all interior parts washed with SOLVENT, dry-cleaning. Dip gears in OIL, engine, seasonal grade, and reassemble. Fill cases sufficiently to insure that gears are partially submerged.

f. **Cradle Trunnion Bearings.** These must be kept thoroughly lubricated at all times.

g. Lubrication frequencies as outlined in the Lubrication Guide are based upon continuous use of the materiel with frequent firing. When, however, the materiel has been unused for a considerable length of time all moving parts will be thoroughly lubricated before maneuvering operations are undertaken.

h. When cleaning sliding or revolving parts of the gun and carriage care must be exercised to remove all dirt, residue or other foreign matter from the parts before lubricant is applied.



**16-INCH SEACOAST GUN MATERIEL  
GUN MK. II M1; BARBETTE CARRIAGE M4**

i. Moisture and grit accumulate in the trunnion bearings. Therefore, they will be cleaned once a year. They will also be cleaned before changing grades of lubricant. Use following procedure:

(1) Remove trunnion covers and clean all grease from bearings, housings and covers with SOLVENT, dry-cleaning.

(2) Thoroughly dry bearings and housing and pack bearings with GREASE, O.D., seasonal grade.

(3) Replace trunnion covers and fill housings with GREASE, O.D., seasonal grade.

j. **Waterbury Hydraulic Speed Gears.** The oil used for a hydraulic medium in Waterbury speed gears becomes contaminated with water, dirt and oxidized oil that combine to form sludge. Although the system is drained, and fresh oil supplied at the specified intervals, a good portion of this sludge remains in the mechanism. To prevent sludge from accumulating, the machine will be disassembled and cleaned once each year.

k. **Traversing Reduction Gears.** Twice a year, these gears will be washed with SOLVENT, dry-cleaning, and coated with GREASE, O.D., seasonal grade.

l. **Breechblock Carrier Hinge Bearings.** To prevent accumulation of moisture and grit in these bearings, they will be disassembled once a year and the parts washed in SOLVENT, dry-cleaning, and repacked with GREASE, O.D., No. 0.

**m. Reports and Records.**

(1) **REPORTS.** If lubrication instructions are closely followed, proper lubricants used and satisfactory results are not obtained, a report will be made to the ordnance officer responsible for the maintenance of the materiel.

(2) **RECORDS.** A complete record of lubrication servicing will be kept in the *Artillery Gun Book* for the materiel.

CARE AND PRESERVATION

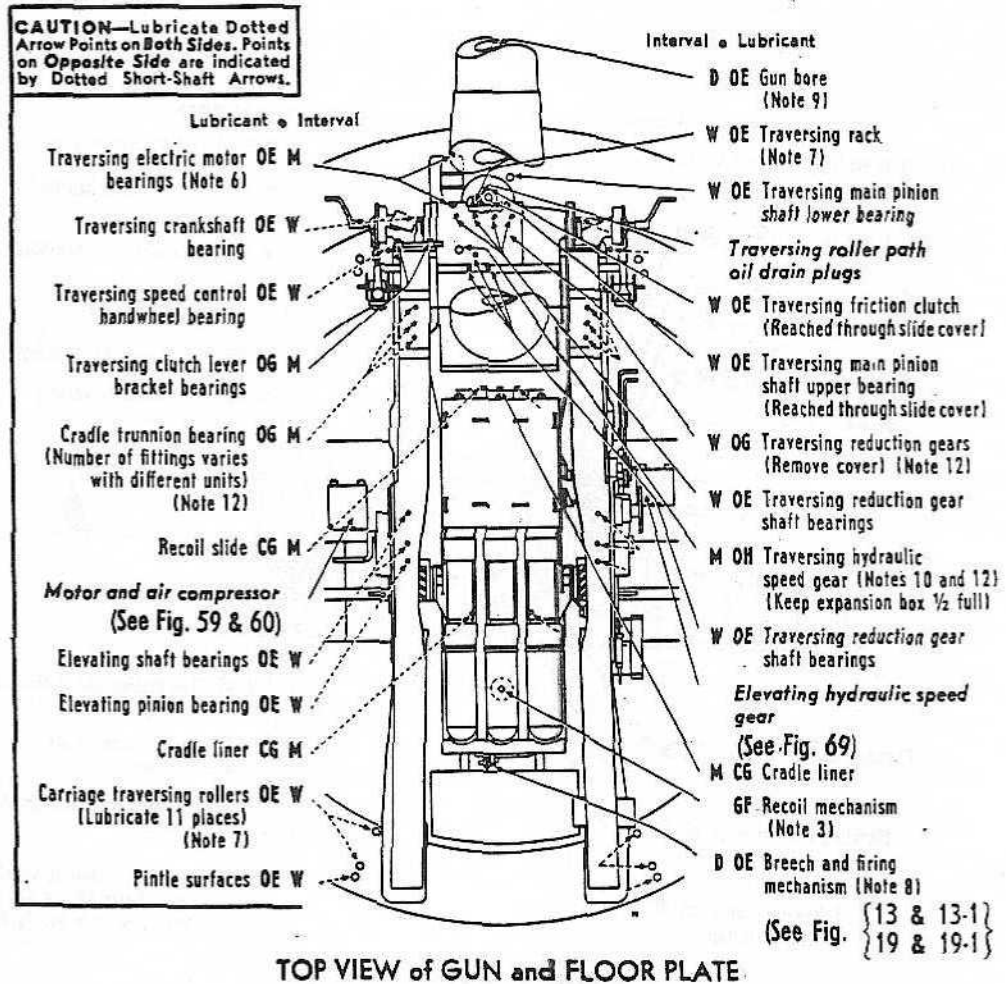

— KEY —

LUBRICANTS		INTERVALS
OE—OIL, engine SAE 30 (above +32° F.) SAE 10 (below +32° F.)	CG—GREASE, general purpose No. 1 (above +32° F.) No. 0 (below +32° F.)	D—DAILY
OG—GREASE, O.D. No. 0 (above +32° F.) No. 00 (below +32° F.)	OH—OIL, hydraulic GF—Glycerin 60% Water 40%	W—WEEKLY
		M—MONTHLY

LUBRICATION INSTRUCTIONS BASED ON INSPECTION OF PRODUCTION MODEL

RA PD 63880

Figure 148-1—Lubrication Guide

**16-INCH SEACOAST GUN MATERIEL  
GUN MK. II M1; BARBETTE CARRIAGE M4**

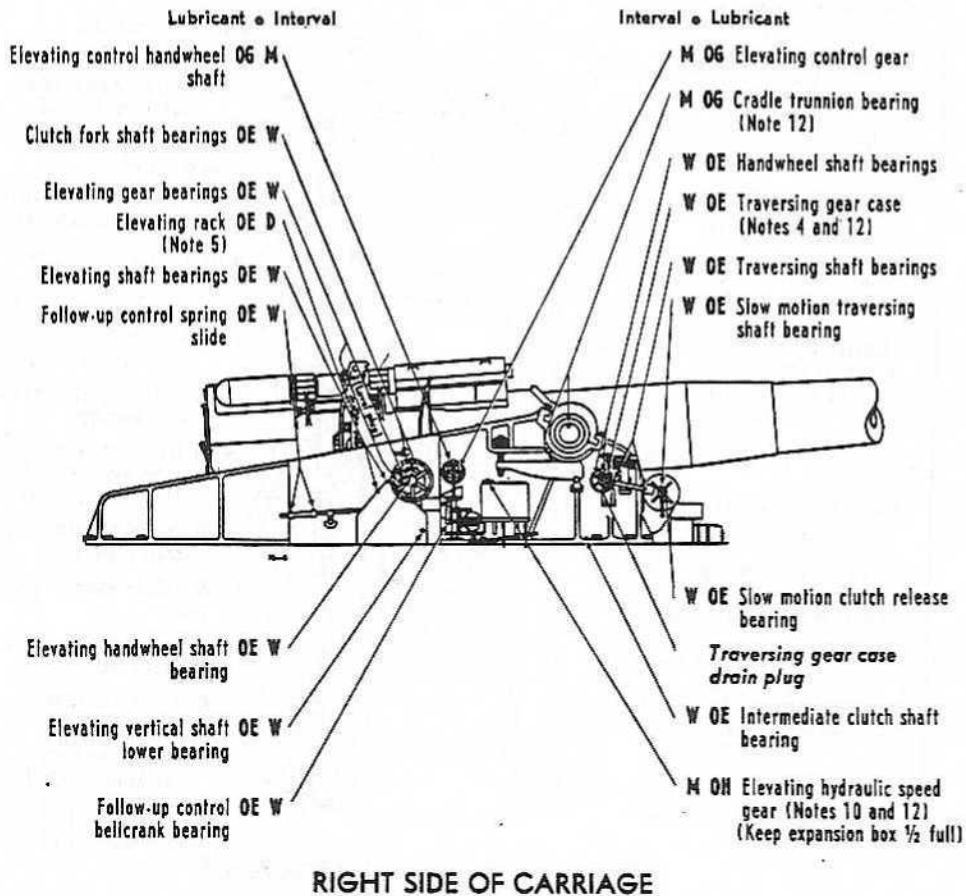

— KEY —

LUBRICANTS	
<p>OE—OIL, engine SAE 30 (above +32° F.) SAE 10 (below +32° F.)</p> <p>OG—GREASE, O.D. No. 0 (above +32° F.) No. 00 (below +32° F.)</p>	<p>OH—OIL, hydraulic</p>

INTERVALS
D—DAILY
W—WEEKLY
M—MONTHLY

**LUBRICATION INSTRUCTIONS BASED ON  
INSPECTION OF PRODUCTION MODEL**

RA PD 63881

## CARE AND PRESERVATION

**NOTES** Additional Lubrication and Service Instructions on Individual Units and Parts. (Refer to Figs. 148-1 and 148-2.) **NOTES**

**COLD WEATHER:** For Lubrication and Service below 0° F refer to OFSB 6-5.

1. **OIL SCREW PLUGS AND FITTINGS**—Clean before applying lubricant. Clean surrounding surface before removing screw plugs. Where bearings can be seen, lubricate fittings until new lubricant is forced from the bearing. **CAUTION:** Lubricate following heavy rains.
2. **INTERVALS** indicated are for normal service. For extreme conditions of heat, water, sand, dust, etc., lubricate more frequently.
3. **RECOIL FLUID**—For instructions on quantity and application of recoil fluid, refer to paragraph 9 f, page 164.
4. **TRAVERSING GEAR CASE**—Weekly, check level; if necessary, add lubricant to correct level. Every 6 months, drain, flush and refill.
5. **ELEVATING RACK AND ALL OTHER ELEVATING AND TRAVERSING OPEN GEARS AND PINIONS**—Daily, apply OIL, engine, seasonal grade. Monthly, clean and reoil. The teeth of the elevating racks, elevating and traversing gears and pinions require little lubrication but, as a protection against rust, they will be kept covered with a thin coat of oil. Since dust and grit will adhere to this oily film if the piece has not been exercised for several days, the teeth will be thoroughly cleaned and fresh OIL, engine, seasonal grade, applied, before exercising or firing the gun. Otherwise, the grit will cause rapid wear of both racks and gears. If considerable dust is present when gun is operated, the oil will be removed from the teeth and they will be allowed to remain dry until action is over. If the surfaces are dry, there is less wear than when coated with a lubricant contaminated with grit.
6. **TRAVERSING ELECTRIC MOTOR BEARINGS**—Monthly, check level. Add lubricant if necessary. **CAUTION:** Do not fill above level plug opening.
7. **TRAVERSING RACK, CARRIAGE TRAVERSING ROLLERS AND RACER**—Traverse gun several times while lubricating to allow oil to reach all surfaces of rollers. Every 3 months, clean with SOLVENT, dry-cleaning, and oil with OIL, engine, seasonal grade. Because dirt and grit accumulate on the traversing rack, carriage traversing rollers and racer, it is necessary to clean them every 3 months. The following procedure is recommended: While slowly traversing the gun, scrub rollers, rack and racer with a brush dipped in SOLVENT, dry-cleaning. Continue traversing and scrubbing until all dirt and sediment is removed from these surfaces and the oil distributing grooves. When thoroughly dry, lubricate parts with OIL, engine, seasonal grade. Traverse the gun 360 degrees, if possible, while lubricating, to make sure that all surfaces are coated.
8. **BREECH AND FIRING MECHANISM**—Daily and before and after firing, clean and oil all moving parts and exposed metal surfaces with OIL, engine, seasonal grade.
9. **GUN BORE**—Daily and after firing, clean and coat with OIL, engine, seasonal grade.
10. **WATERBURY HYDRAULIC SPEED GEARS**—Monthly, check level. If necessary, add OIL, hydraulic, to correct level. Every 6 months, drain and refill with fresh OIL, hydraulic. The expansion and contraction of OIL, hydraulic, in these units produces a breathing action in the expansion chamber. This chamber is vented to the

**16-INCH SEACOAST GUN MATERIEL  
GUN MK. II M1; BARBETTE CARRIAGE M4**

atmosphere so moisture and dust are drawn into the system, making it essential that the system be drained every 6 months and refilled with fresh oil.

11. OIL CAN POINTS—Weekly, lubricate automatic clutch mechanism, control rod clevises, linkage, hinges, latches, handwheel handles, etc., with OIL, engine, seasonal grade.

12. POINTS TO BE SERVICED AND/OR LUBRICATED BY ORDNANCE MAINTENANCE PERSONNEL AT TIME OF ORDNANCE INSPECTION—Cradle trunnion bearings, traversing gear case, Waterbury hydraulic speed gears, traversing reduction gears. (Refer to pages 121, 122, 197 and 200.)

**NOTES Additional Lubrication and Service Instructions on Individual Units and Parts. (Refer to Figs. 148-3 and 148-4.)**

**COLD WEATHER:** For Lubrication and Service below 0° F refer to OFSB 6-5.

1. OIL SCREW PLUGS AND FITTINGS—Clean before applying lubricant. Clean surrounding surface before removing screw plugs. Where bearings can be seen, lubricate fittings until new lubricant is forced from the bearing. CAUTION: lubricate, following heavy rains.

2. INTERVALS indicated are for normal service. For extreme conditions of heat, water, sand, dust, etc., lubricate more frequently.

3. TRAVERSING GEAR CASE—Weekly, check level. If necessary, add lubricant to correct level. Every 6 months, drain, flush and refill.

4. ELEVATING RACK AND ALL OTHER ELEVATING AND TRAVERSING OPEN GEARS AND PINIONS—Daily, apply OIL, engine. Monthly, clean and reoil. The teeth of the elevating racks, elevating and traversing gears and pinions, require little lubrication but, as a protection against rust, they will be kept covered with a thin coat of oil. Since dust and grit will adhere to this oily film if the piece has not been exercised for several days, the teeth will be thoroughly cleaned, and fresh OIL, engine, seasonal grade, applied before exercising or firing the gun. Otherwise, the grit will cause rapid wear of both racks and gears. If considerable dust is present when gun is operated, the oil

will be removed from the teeth and they will be allowed to remain dry until action is over. If the surfaces are dry, there is less wear than when coated with a lubricant contaminated with grit.

5. HYDRAULIC SPEED GEAR AND LOADING MECHANISM ELECTRIC MOTOR BEARINGS—Monthly, check level, add lubricant, if necessary. CAUTION: Do not fill through fill plugs without removing level plugs on side.

6. AIR COMPRESSOR CRANKCASE—Daily, check level. Add oil if necessary. Every 3 months, drain, flush and refill. The compressors provided employ a lubricating system of the automotive type, wherein the crankcase serves as an oil reservoir and the oil is circulated by a pump or by the splash of the connecting rods dipping into the oil on each revolution of the crankshaft. Due to the high temperatures generated during compression, the under side of the piston heads becomes heated to the extent that oil contacting them is partially vaporized and a gummy substance is formed that tends to thicken the oil in the reservoir. This condition is aggravated by oxidation of the oil from agitation in air breathed into the crankcase; consequently, the reservoir will be drained and refilled with fresh oil at least every 3 months.

## CARE AND PRESERVATION

7. WATERBURY HYDRAULIC SPEED GEARS—Monthly, check level. If necessary, add OIL, hydraulic, to correct level. Every 6 months, drain and refill with fresh OIL, hydraulic. The expansion and contraction of OIL, hydraulic, in these units produces a breathing action in the expansion chamber. This chamber is vented to the atmosphere so moisture and dust are drawn into the system, making it essential that the system be drained every 6 months and refilled with fresh oil.
8. AIR COMPRESSOR AIR CLEANERS—Weekly, or more often, if necessary, wash filter element, dry and reoil with used crankcase oil or OIL, engine, crankcase grade.
9. AIR COMPRESSOR OIL FILTER—Daily, turn handle one full turn. Weekly, remove plug and drain sediment.
10. OIL CAN POINTS—Weekly, lubricate loading arm bearings, turntable cam slide and shell release shaft bearings, hinges, latches, linkage, hand-wheel handles, universal joints, etc., with OIL, engine, seasonal grade.
11. POINTS TO BE SERVICED AND/OR LUBRICATED BY ORDNANCE MAINTENANCE PERSONNEL AT TIME OF ORDNANCE INSPECTION—Waterbury hydraulic speed gears, breech-block carrier hinge bearings, traversing gear case, cradle trunnion bearing. (Refer to pages 197, 200 and 201.)

**16-INCH SEACOAST GUN MATERIEL  
GUN MK. II M1; BARBETTE CARRIAGE M4**

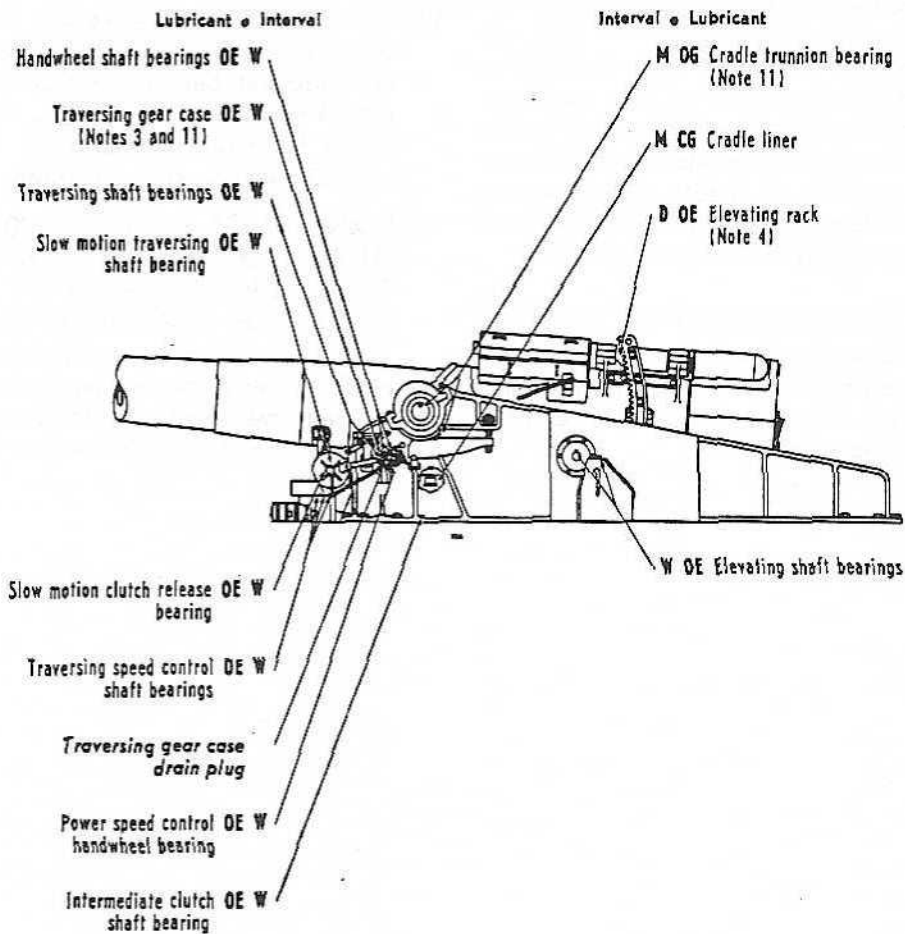

LEFT SIDE OF CARRIAGE

**KEY**

LUBRICANTS	
OE—OIL, engine SAE 30 (above +32° F.) SAE 10 (below +32° F.)	OG—GREASE, O.D. No. 0 (above +32° F.) No. 00 (below +32° F.)
CG—GREASE, general purpose No. 1 (above +32° F.) No. 0 (below +32° F.)	

INTERVALS
D—DAILY
W—WEEKLY
M—MONTHLY

**LUBRICATION INSTRUCTIONS BASED ON  
INSPECTION OF PRODUCTION MODEL**

RA PD 63882

**Figure 148-3—Lubrication Guide**

CARE AND PRESERVATION

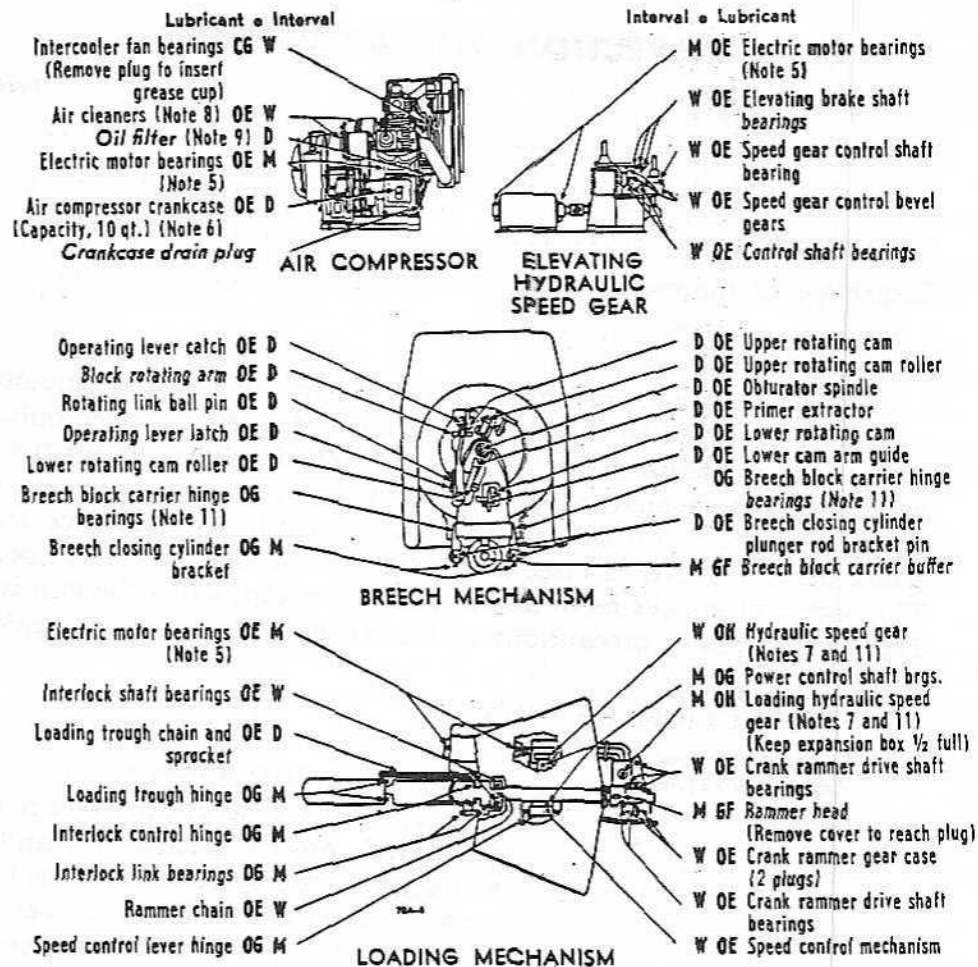

KEY

LUBRICANTS	
OE—OIL, engine SAE 30 (above +32° F.) SAE 10 (below +32° F.)	CG—GREASE, general purpose No. 1 (above +32° F.) No. 0 (below +32° F.)
OG—GREASE, O.D. No. 0 (above +32° F.) No. 00 (below +32° F.)	GF—Glycerin 40% Water 40%
	OH—OIL, hydraulic

INTERVALS
D—DAILY
W—WEEKLY
M—MONTHLY

LUBRICATION INSTRUCTIONS BASED ON INSPECTION OF PRODUCTION MODEL

RA PD 63883

Figure 148-4—Lubrication Guide



16-INCH SEACOAST GUN MATERIEL  
GUN MK. II M1; BARBETTE CARRIAGE M4

Section V

INSPECTION AND ADJUSTMENT

	Paragraph
General .....	20
Inspection of gun.....	21
Inspection of carriage.....	22
Inspection of rammer.....	23

20. GENERAL.

a. Inspection and adjustment of the parts of the gun, mount and rammer as referred to in this manual are intended to cover only such inspection and adjustments as can be conveniently made by the using service with the available tools furnished with the gun and mount. Additional inspection and adjustment will be made by ordnance maintenance personnel. NOTE: See that recoil parts lock is in correct position. This lock will *always be in locked position* except when the gun is to be fired, when special precautions will be taken to see that it is *unlocked*.

21. INSPECTION OF GUN.

Part to be Inspected or  
Adjusted in Sequence

Points to Observe

- a. Note the general appearance of the gun barrel, breech mechanism, and parts of the gas ejector system. Examine finished surfaces for evidence of rust or accumulations of dirt or other foreign matter. Note whether painted surfaces are scratched or otherwise defaced and take corrective action.
- b. Breech Recess.      b. Note whether there are scores or burs on bearing surfaces and make corrections.
- c. Breechblock.      (1) Note whether bearing surfaces are scored or otherwise deformed and whether dummy pressure plugs in the obturator are securely in place.
- (2) Examine the aperture through the obturator spindle to see that it is clean and free from grease, dirt, or other foreign matter.
- (3) Check tension on obturator spring and note that the spring nut is securely in place.

## INSPECTION AND ADJUSTMENT

Part to be Inspected or Adjusted in Sequence	Points to Observe
d. Oil Gage.	(4) Examine the projections and splines on the end of the obturator spindle for evidence of burs or other deformations and, if present, take corrective action.
e. Breech Mechanism Lubrication.	d. Ascertain whether there is sufficient oil in the air compressor crankcase using the graduated oil level gage (fig. 122). e. Note that all parts of the breech mechanism and the moving parts of the breech closing device are properly lubricated.
f. Breech Mechanism.	f. Open and close the breechblock several times using hand power and note that the various parts of the mechanism work freely and that there is no binding or "hard spots" in evidence during the operation. If the mechanism does not work freely in every particular, refer the matter to the ordnance maintenance personnel for corrective action.
g. Gas Ejector System.	g. Note that the air gage in the main pipe line under the left platform registers air pressure of approximately 150 pounds per square inch.
h. Gas Ejector Valve.	h. With breechblock in open position (fig. 10) and breech closing valve (Y, fig. 13) closed, operate the gas ejector valve (R, fig. 13) and note that there is no obstruction to free passage of air to the breech and powder chamber. (1) Close the gas ejector valve and open the breech closing valve. Note that the air pressure closes the parts of the breech mechanism smoothly. (2) Any failure of perfect operation should be reported to the ordnance maintenance personnel for correction.
i. Breech Closing Valve.	(1) Set the pressure in the air reducing valve (fig. 23) to insure proper operation of the breech closing and gas ejecting systems. (2) Note that turning the adjusting screw on the top of the air reducing valve clockwise increases the speed of movement of the breech closing mechanism. Turning the screw counterclockwise reduces the speed.
j. Air Reducing Valve.	

**16-INCH SEACOAST GUN MATERIEL  
GUN MK. II M1; BARBETTE CARRIAGE M4**

Part to be Inspected or  
Adjusted in Sequence

Points to Observe

**k. Air Pipe Line.**

k. With maximum air pressure in operation examine the parts of the air pipe line, closing cylinders, storage tanks and connecting pipes for escaping air. If air is escaping at any point in the system, notify the ordnance maintenance personnel so that corrective action may be taken.

**l. Hydraulic Cylinders.**

l. See that the hydraulic cylinders in the salvo latch mechanism and carrier buffer are supplied with the correct amount of fluid.

**m. Holding Bolts.**

m. Check all holding bolts, screws, nuts and washers to insure that the parts of the gun are securely in place.

**22. INSPECTION OF CARRIAGE.**

a. Note general appearance of the mount with reference to defacement of painted surfaces, accumulation of rust on finished surfaces, and presence of dirt, grease or other foreign matter on the surfaces of the mount. Check exposed "pockets" and other recesses for accumulated dirt, grit and similar matter and take corrective action.

**b. Roller Path and Traversing Rollers.**

b. Remove a section of the traversing roller dust guard and traverse the mount through its permissible travel of  $72\frac{1}{2}$  degrees in both directions. Note the condition of traversing rollers and roller path to see that sufficient oil is being supplied to these parts. Note whether there is evidence of rust or dirt on the rollers or roller path, and, if present, remove.

**c. Traversing by Hand.**

c. Test the effort required to traverse the mount by hand power within permissible limits following the procedure outlined in section III, paragraph 9 j under "Operation of the Gun and Carriage." Note that the mount traverses smoothly and without evidence of undue friction.

**d. Traverse by Electric Power.**

d. Maneuver the mount by power to right and left extremes of traverse following the procedure outlined in section III, paragraph 9 k under "Operation of Gun

## INSPECTION AND ADJUSTMENT

Part to be Inspected or  
Adjusted in Sequence

Points to Observe

and Carriage." Note that the various mechanisms operate smoothly and that there is no evidence of "drag" or binding of the moving parts.

**e. Antifriction Device.**

(1) Test clearance between the cradle trunnions and trunnion beds in the side frames to insure that there is clearance of exactly 0.008 inch at this point. Thickness gages are supplied with the mount for making this test. If there is insufficient clearance, back off the lower spring rod lock nuts (B, fig. 76) slightly and take up on the lower spring rod collar nuts (C, fig. 76) until sufficient clearance is indicated. If test indicates too great clearance, back off lower spring rod lock nuts and adjust lower spring rod collar nuts until proper clearance is obtained. After adjustments have been made, screw the lower spring rod lock nuts securely in place against the face of the spring rod collar nuts.

(2) The clearance between the trunnions and trunnion beds should be identical on both sides of the mount.

(3) No attempt will be made to elevate or depress the gun until it is determined that a clearance of 0.008 inch exists at this point.

(4) For method of making thickness gage test, see figure 137.

(5) No adjustment of the tension on the Belleville springs will be undertaken by the using service.

**f. Air Pressure in Recuperators.**

f. Test the air pressure in the recuperator cylinders as outlined in section III, paragraph 9 d (1) under "Operation of Gun and Carriage."

**g. Liquid Pressure in Recuperators.**

g. Test the liquid pressure in the recuperator cylinders as outlined in section III, paragraph 9 e (1).

**h. Liquid Indicators.**

(1) Note position of liquid indicators on the ends of the recuperator cylinders to ascertain that they are within the maximum limits of position as outlined in section III, paragraph 9 e (1).

## 16-INCH SEACOAST GUN MATERIEL GUN MK. II M1; BARBETTE CARRIAGE M4

Part to be Inspected or  
Adjusted in Sequence

Points to Observe

### i. Elevating Brakes.

(2) Examine recuperator yoke rods and plungers for evidence of scoring which, if found present, should be referred to the ordnance maintenance personnel.

(1) Test the elevating brake system by raising the brake levers (fig. 135) and releasing them several times. Note the holding power of the brakes on the brake drums when released.

(2) Check the clearance between the brake drums and brake bands making this observation and test by means of peephole in the drum shaft bearing on the left side and gear case on the right side of the mount (fig. 132).

(3) There should be a clearance of  $\frac{1}{32}$  inch between the band and drums when the brake levers are raised to maximum position.

(4) If there is evidence of failure of the brake bands to securely grip the brake drums, make adjustment of the parts as indicated in figure 134 and outlined in section III, paragraph 9 h (3) and (4) under "Elevating Brakes."

### j. Elevating by Hand.

j. Elevate and depress the gun by hand power within the permissible limit from minus 3 degrees to 46 degrees elevation with gun loaded with weight equal to one-half service charge, also with gun unloaded, and note whether excessive effort is necessary to accomplish these maneuvers.

### k. Elevating by Power.

(1) Upon completion of elevating test by hand power maneuver the gun through its permissible movement of elevation and depression by electric power as outlined in section III, paragraph 9 i.

(2) Note that the follow-up control parts work freely and smoothly and that the knee operated lever can be easily operated to throw the clutches out of engagement at extremes of elevation and depression.

## INSPECTION AND ADJUSTMENT

Part to be Inspected or Adjusted in Sequence	Points to Observe
<p><b>l. Speed-gear Expansion Tanks.</b></p>	<p>1. All speed-gear expansion tanks should be kept half filled with oil at all times. If there is a deficiency of oil in any tank, examine the piping and speed gears for evidence of leakage.</p> <p>(1) Ascertain that there is sufficient liquid in the recoil cylinder by removing the plug cap (K, fig. 46) from the tee (J, fig. 46) in the expansion chamber piping. If there is an overflow of liquid at this point, it will indicate that the recoil cylinder is full. If there is no overflow of liquid, replenish the liquid in the cylinder until the liquid flows from the opening in the tee.</p> <p>(2) Note the condition of the cylinder rod and check for scratches or abrasions which, if present, should be referred to the ordnance maintenance personnel for correction.</p>
<p><b>m. Recoil Cylinder.</b></p>	
<p><b>n. Cradle Liners.</b></p>	<p>n. Examine the finished, exposed under surface of the gun for evidence of bronze dust or scrapings which may have been worn from the bronze cradle liners due to excessive friction during recoil and counterrecoil of gun. If this condition is found present, the matter should be referred to the ordnance maintenance personnel for action.</p>
<p><b>o. Lubricating Gun and Cradle.</b></p>	<p>o. Check the general appearance of the sliding surfaces of the gun and cradle for evidence of dryness due to insufficient lubricant and make corrections as necessary.</p>
<p><b>p. Dust Guards and Gear Covers.</b></p>	<p>p. Examine all dust guards and gear covers to see that they are securely in place and that there is no excessive friction of moving parts connected with these devices.</p>
<p><b>q. Lubricating Devices.</b></p>	<p>q. Check all lubricating fittings for correct functioning of covers or other closing devices. Observe the condition of tubes and channels to ascertain if there is any clogging of the tubes or orifices due to sediment, deformation or other causes. Note that all oil plugs and similar lubricating devices are painted red.</p>

**16-INCH SEACOAST GUN MATERIEL  
GUN MK. II M1; BARBETTE CARRIAGE M4**

Part to be Inspected or  
Adjusted in Sequence

Points to Observe

**r. Stuffing Boxes.**

r. Examine all stuffing boxes on the mount for evidence of leakage. If there is leakage at any point, tighten the followers slightly. If leakage continues, refer the matter to the ordnance maintenance personnel for correction.

**s. Tools and Accessories.**

s. Check tools and accessories to insure that a full complement of these items is on hand and that they are in serviceable condition.

**t. Holding Bolts.**

t. Check all holding bolts, screws, nuts and washers to insure that all parts of the carriage are securely in place.

**23. INSPECTION OF RAMMER.**

a. Ascertain that the rammer head cylinder is filled with liquid and the rammer chain properly lubricated. Open breechblock, insert the trough and maneuver the rammer chain through its permissible movement using hand power for this purpose.

(1) Test the operation of the loading trough to see that it can be maneuvered with a minimum of effort to its folded and extended positions, and that the end of the trough rests properly in the gun breech in loading position.

(2) Upon completion of the above test remove hand cranks and operate the head and chain by electric power in accordance with procedure outlined in section III, paragraph 10 a and b.

**b. Holding Bolts.**

b. Check all holding bolts, screws, nuts and washers to insure that the parts of the rammer are securely in place.

Section VI

**MALFUNCTIONS AND CORRECTIONS**

	Paragraph
General .....	24
Malfunctions of gun.....	25
Malfunctions of carriage.....	26
Malfunctions of rammer.....	27

**24. GENERAL.**

a. The efficient operation of the gun and carriage depends upon the proper functioning of the various unit parts and assemblies making up the complete mount.

(1) Wherever there is evidence of malfunctioning of any of the parts corrective action should be taken at once in order to maintain the mount in readiness for immediate service. Such malfunctions as come within the range of corrections which can be made by the using service, with tools and facilities furnished with the mount, should be given immediate attention. Any evidence of malfunctions or failure of parts not specifically outlined herein, will be brought to the attention of the ordnance maintenance personnel. Malfunctioning of parts of electrical equipment including firing lock is covered in section VIII, paragraph 38.

**25. MALFUNCTIONS OF GUN.**

Malfunction	Cause	Correction
a. Deformation of cradle.	(1) Due to weight of gun and firing shocks.	(1) Refer to ordnance maintenance personnel.
	(2) Excessive wear and scoring of cradle liners.	(2) Refer to ordnance maintenance personnel.
	(3) Insufficient lubricant on the sliding surfaces of the gun and cradle.	(3) Add lubricant.
b. Failure of breechblock carrier to maneuver easily into open or closed position.	(1) Lack of proper lubrication of the moving parts.	(1) Lubricate all moving parts of the breech mechanism.
	(2) Lack of sufficient air pressure in air compressor unit.	(2) Operate air compressor motor until pressure is built up to maximum of 150 pounds per square inch.
	(3) Leak in compressed air line.	(3) Refer to ordnance maintenance personnel.



**16-INCH SEACOAST GUN MATERIEL  
GUN MK. II M1; BARBETTE CARRIAGE M4**

Malfunction	Cause	Correction
	(4) Improper setting of pressure reducing valve.	(4) Reset to insure proper flow of air to closing cylinders.
	(5) Weak or broken cylinder closing spring.	(5) Refer to ordnance maintenance personnel.
	(6) Improper setting of the carrier hinge pin eccentric bushing.	(6) Refer to ordnance maintenance personnel for correct setting.
c. Failure of salvo latch to engage operating lever.	(1) Distortion of parts of salvo latch.	(1) Refer to ordnance maintenance personnel.
	(2) Loosened holding bolts.	(2) Tighten.
	(3) Lack of liquid in hydraulic cylinder.	(3) Replenish liquid.
	(4) Weak or broken salvo latch spring.	(4) Refer to ordnance maintenance personnel.
	(5) Weak or broken buffer plunger spring.	(5) Refer to ordnance maintenance personnel.
	(6) Weak or broken operating lever latch spring.	(6) Refer to ordnance maintenance personnel.
	(7) Weak or broken operating lever catch spring.	(7) Refer to ordnance maintenance personnel.
d. Failure of firing lock retracting lever to properly engage retracting lever catch.	(1) Deformation of lever parts.	(1) Refer to ordnance maintenance personnel.
	(2) Weak or broken retracting lever latch spring.	(2) Refer to ordnance maintenance personnel.
e. Failure of firing lock operating bar to properly engage firing lock.	(1) Deformation of latch.	(1) Refer to ordnance maintenance personnel.
	(2) Broken or deformed latch handle.	(2) Refer to ordnance maintenance personnel.
	(3) Weak or broken latch spring.	(3) Refer to ordnance maintenance personnel.

### MALFUNCTIONS AND CORRECTIONS

Malfunction	Cause	Correction
f. Failure of breech-block carrier holding down handle to lock breech in open position.	(1) Weak or broken latch spring.	(1) Refer to ordnance maintenance personnel.
	(2) Loosened holding bolts in latch lever or tripping handle brackets.	(2) Tighten bolts.
	(3) Broken or deformed pins in upper or lower latch levers.	(3) Refer to ordnance maintenance personnel.
g. Failure of gas ejector valve to open or close with rotating movement of breech-block.	(1) Deformed body plunger.	(1) Refer to ordnance maintenance personnel.
	(2) Weak or broken body plunger spring.	(2) Refer to ordnance maintenance personnel.
	(3) Distorted or broken valve cam.	(3) Refer to ordnance maintenance personnel.
	(4) Loose gas ejector valve trip plate.	(4) Tighten.
h. Failure of breech closing valve to completely shut off flow of air to closing cylinders.	(1) Broken or distorted valve body handle.	(1) Refer to ordnance maintenance personnel.
	(2) Loose body adjusting stud.	(2) Adjust stud and tighten clamping body bolt.
i. Failure of pressure reducing valve to properly regulate flow of air to gas ejector valve and closing cylinders.	(1) Weak or broken diaphragm spring, main valve spring or auxiliary valve spring.	(1) Refer to ordnance maintenance personnel.
	(2) Jammed or broken main valve.	(2) Refer to ordnance maintenance personnel for overhaul.
	(3) Jammed or broken auxiliary valve.	(3) Refer to ordnance maintenance personnel for overhaul.

**16-INCH SEACOAST GUN MATERIEL  
GUN MK. II M1; BARBETTE CARRIAGE M4**

Malfunction	Cause	Correction
j. Failure of carrier buffer body plunger to return to full extended position.	(1) Weak or broken body plunger spring.	(1) Refer to ordnance maintenance personnel.
	(2) Lack of fluid in buffer cylinder.	(2) Refill.
<b>26. MALFUNCTIONS OF CARRIAGE.</b>		
a. Failure of mount to traverse easily within permissible limits.	(1) Dirt, sediment, rust or gummed oil on rollers and roller paths.	(1) Remove section of roller dust guard and platform plates and clean with SOLVENT, dry-cleaning. Remove rust.
	(2) Lack of sufficient lubricant on rollers, roller paths and pintles.	(2) Oil roller bearings and pintle surface through racer oilholes. Use grease gun on ale-mite fittings in base ring to lubricate pintle surface.
	(3) Expansion of racer pintle due to sun's heat.	(3) Refer to ordnance maintenance personnel.
	(4) Lack of lubrication or presence of rust on traversing rack and traversing pinion.	(4) Remove rust, clean and lubricate.
	(5) Excessive friction on traversing roller dust guards.	(5) Disassemble guards and remove high spots.
	(6) Lack of proper lubrication of gears, pinions and bearings in the traversing mechanism.	(6) Lubricate parts in accordance with information contained in the Lubrication Guide.
	(7) Presence of dirt, rust and gummed oil on parts of traversing mechanism.	(7) Clean and lubricate.
b. Failure of traversing gearing and pinion to rotate the carriage.	b. Lack of sufficient friction on the disks in the traversing gear friction box.	b. Tighten vertical traversing shaft nut just sufficiently to prevent slipping of the parts during normal traversing.

**MALFUNCTIONS AND CORRECTIONS**

Malfunction	Cause	Correction
c. Failure of traversing handwheel clutch treadle to return to full "UP" position when released.	(1) Distortion of treadle parts.	(1) Refer to ordnance maintenance personnel.
	(2) Lack of lubrication.	(2) Lubricate all moving parts of device.
d. Failure of tipping parts to operate easily within permissible limits of elevation and depression.	(1) Improper setting of antifriction device.	(1) Proceed as outlined in section V, paragraph 22 e (1), (2), (3), (4) and (5).
	(2) Gun out of balance.	(2) Refer to ordnance maintenance personnel.
	(3) Presence of dirt, grit, rust, or gummed oil on elevating parts.	(3) Clean and lubricate.
	(4) Lack of sufficient lubricant on moving parts.	(4) Lubricate parts in accordance with information contained in Lubrication Guide.
	(5) Insufficient clearance between brake bands and brake drums when brake levers are raised.	(5) Make adjustment of elevating brake band spring and support and gripping spring as outlined in figures 132 and 133 in section III, paragraph 9 h (3) and (4) under "Elevating Brakes."
	(6) Weak or broken brake band support or brake gripping springs.	(6) Refer to ordnance maintenance personnel.
	(7) Burs or deformations on elevating racks or elevating pinion.	(7) Remove.
	(8) Burs or deformations on elevating data receiver rack or pinion.	(8) Refer to ordnance maintenance personnel.
	(9) Weak or broken springs, deformed or broken parts in follow-up control clutch-locking device.	(9) Refer to ordnance maintenance personnel.
e. Failure of gun to return to battery when fired.	(1) Lack of lubrication on cradle and gun.	(1) Add lubricant.

**16-INCH SEACOAST GUN MATERIEL  
GUN MK. II M1; BARBETTE CARRIAGE M4**

<b>Malfunction</b>	<b>Cause</b>	<b>Correction</b>
	(2) Insufficient air in recuperator cylinders.	(2) Replenish in accordance with procedure outlined in section III, paragraph 9 d. If failure persists, notify ordnance maintenance personnel.
	(3) Burs or deformations on plungers and recuperator yoke rods.	(3) Refer to ordnance maintenance personnel.
	(4) Lack of lubricant and presence of rust, dirt or other foreign matter on recuperator plunger yoke and yoke shoe slides.	(4) Clean and lubricate.
	(5) Abrasions or deformation of cradle liners due to weight of gun and firing shocks.	(5) Refer to ordnance maintenance personnel.
f. Failure of gun to fully recoil when fired.	(1) Same reasons as outlined in e (1), (3), (4) and (5) under "Failure of Gun to Return to Battery."	(1) Same corrections as outlined in e (1), (3), (4) and (5) under "Failure of Gun to Return to Battery."
	(2) Excessive air pressure in recuperator cylinders.	(2) Bring air and liquid pressure in recuperators into balance in accordance with procedure outlined in section III, paragraph 9 d.
	(3) Deformation of throttling rods or misalignment of apertures in recoil cylinder.	(3) Refer to ordnance maintenance personnel.
	(4) Abrasions or deformations on recoil cylinder piston rod.	(4) Refer to ordnance maintenance personnel.
	(5) Excessive pressure on recoil cylinder glands and packing.	(5) Relieve pressure by releasing packing gland nut slightly. (Not more than one-quarter turn.)

**MALFUNCTIONS AND CORRECTIONS**

Malfunction	Cause	Correction
<b>27. MALFUNCTIONS OF RAMMER.</b>		
a. Failure of rammer to properly seat projectile in gun.	(1) Lack of proper lubrication of the moving parts of the rammer.	(1) Lubricate.
	(2) Lack of liquid in rammer cylinder head.	(2) Refill.
	(3) Improper setting of the rammer unstroking device.	(3) Refer to ordnance maintenance personnel.

**16-INCH SEACOAST GUN MATERIEL  
GUN MK. II M1; BARBETTE CARRIAGE M4**

**Section VII**

**DISASSEMBLY AND ASSEMBLY OF GUN,  
CARRIAGE AND RAMMER**

	Paragraph
General .....	28

**28. GENERAL.**

a. In general, the disassembly and assembly of the various mechanisms making up the complete mount will be undertaken only under supervision of trained ordnance personnel. Such assembling and disassembling as may be necessary for the operating service to make, covering periodical inspection of the parts and for the care and maintenance of the materiel, is of such a nature as to require no special instructions in this manual.

b. Whenever it is necessary to remove any part from the gun, carriage, or rammer for the purpose of inspection, care, or maintenance of the materiel, precautions will be taken to see that the part is re-assembled in the exact position from which it was removed.

c. Tools and accessories for assembling and disassembling are carried in the armament chest and at the fortification; no tools other than those specified for this purpose will be used.

d. Instructions covering disassembly and assembly of electrical equipment are outlined in section VIII of this manual.

### DESCRIPTION AND FUNCTIONING

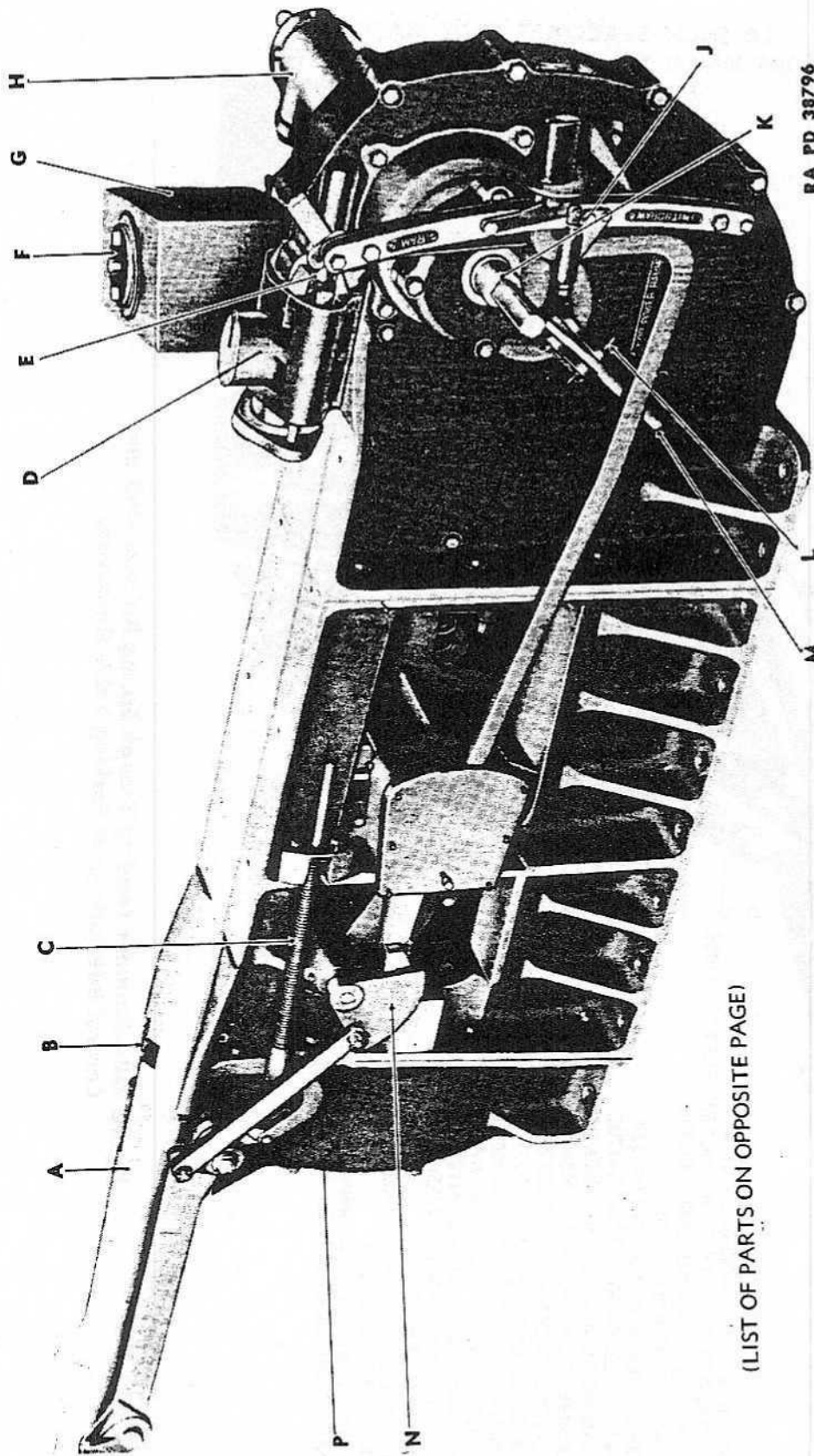

RA PD 38796

(LIST OF PARTS ON OPPOSITE PAGE)

**Figure 107-1—Rammer (Left Side) with Loading Trough in Extended Position (Parking Tables Removed)**  
(LEGEND ON OPPOSITE PAGE)



16-INCH SEACOAST GUN MATERIEL  
GUN MK. II M1; BARBETTE CARRIAGE M4

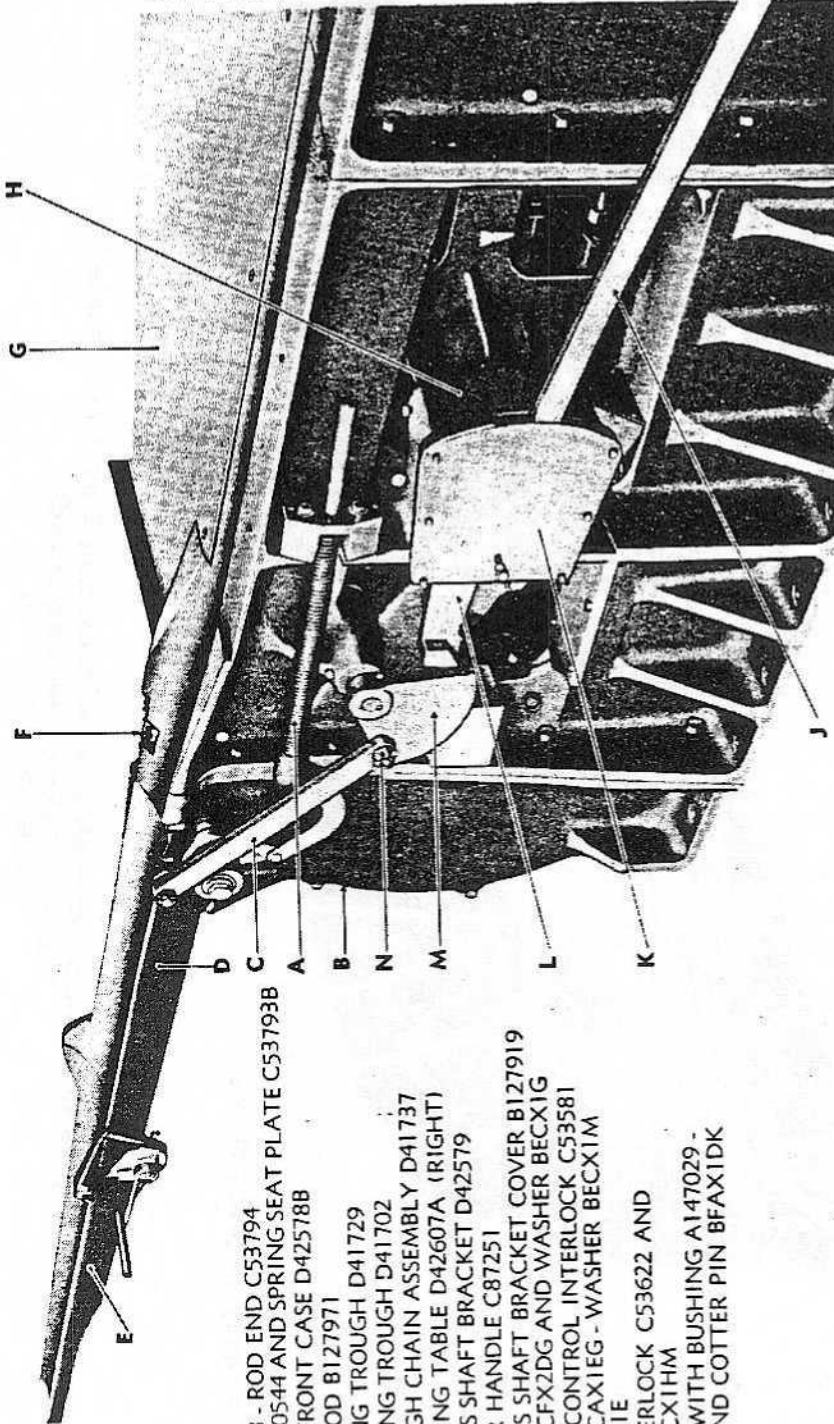

RA PD 38798

- A — SPRING B160543 - ROD END C53794  
SPRING ROD B160544 AND SPRING SEAT PLATE C53793B
- B — RAMMER LEFT FRONT CASE D42578B
- C — CONNECTING ROD B127971
- D — (REAR) LOADING TROUGH D41729
- E — (FRONT) LOADING TROUGH D41702
- F — LOADING TROUGH CHAIN ASSEMBLY D41737
- G — RAMMER PARKING TABLE D42607A (RIGHT)
- H — RAMMER CROSS SHAFT BRACKET D42579
- I — CONTROL LEVER HANDLE C87251
- J — CONTROL CROSS SHAFT BRACKET COVER B127919
- K — CONTROL CROSS SHAFT BRACKET COVER B127919  
WITH SCREW BCFX2DG AND WASHER BECX1G
- L — SEGMENT AND CONTROL INTERLOCK C53581  
WITH SCREW BCAX1EG - WASHER BECX1M  
AND NUT BBAX1E
- M — CONTROL INTERLOCK C53622 AND  
TAPER PIN BFCX1HM
- N — STUD A147028 WITH BUSHING A147029 -  
NUT BBEX1F AND COTTER PIN BFAX1DK

Figure 108—Rammer Loading Trough Spring Balance Unit and  
Control Interlock (Left Parking Table Removed)

DESCRIPTION AND FUNCTIONING

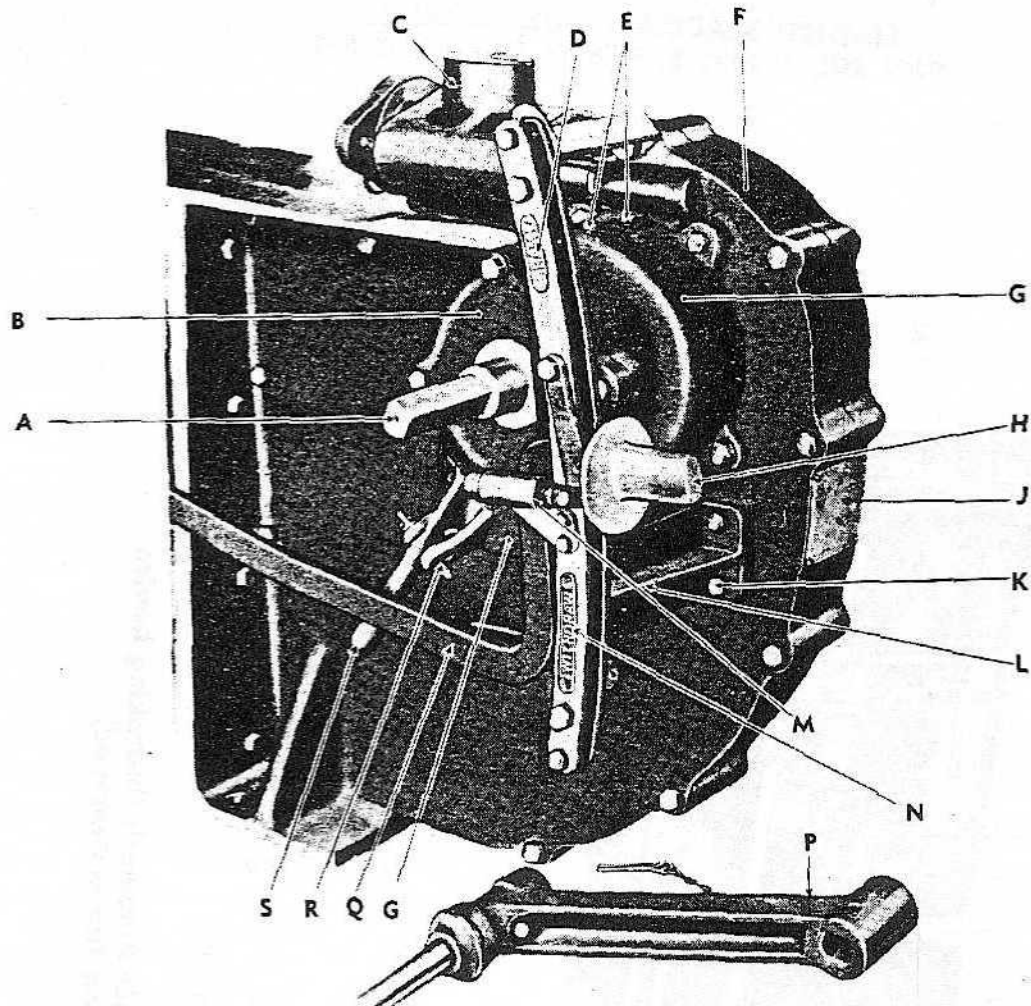

- |  |  |
|--|--|
| A—RAMMER CHAIN SPROCKET AND CLUTCH (ASSEMBLY) D42591   | K—SCREW BCAX1EF AND WASHER BECX1M  |
| B—GEAR CASE COVER B163133 AND SCREW BCAX2AD            | L—BRACKET C83778 AND (SECTOR) SCREW BCDX1BD—NUT BBAX1E AND WASHER BECX1M |
| C—RAMMER HEAD (ASSEMBLY) D42583                        | M—CONTROL LEVER DETENT (ASSEMBLY) D46252                                 |
| D—DIRECTION PLATE A147986 AND SCREW BCKX4CE            | N—DIRECTION PLATE A147985 AND SCREW BCKX4CE                              |
| E—OIL PLUG A80S3                                       | P—CRANK (ASSEMBLY) C54921  |
| F—RAMMER CASE AND SPEED GEAR CONTROL (ASSEMBLY) D42588 | Q—SPEED GEAR CONTROL LEVER C53582  |
| G—GEAR CASE D46251 AND SCREW BCAX2AB                   | R—TOGGLE PIN (ASSEMBLY) B163186  |
| H—CONTROL LEVER HANDLE C87251                          | S—POWER CLUTCH FORK (ASSEMBLY) B163152                                   |
| J—COVER A7518 AND SCREW BCFX2BD                        |  |

RA PD 38799

**Figure 109—Rammer Control Lever Latch and Clutch Handle  
(Parking Tables Removed)**

16-INCH SEACOAST GUN MATERIEL  
GUN MK. II M1; BARBETTE CARRIAGE M4

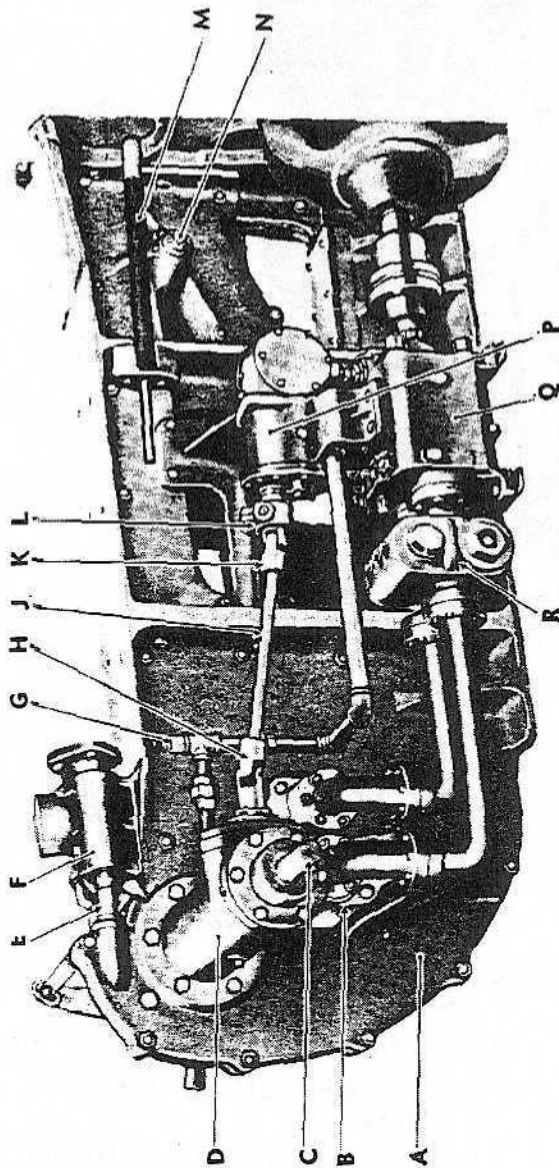

- A — RAMMER CASE D42574 (RIGHT REAR)
- B — RAMMER HYDRAULIC SPEEDGEAR ("B" END) D
- C — CHAIN SPROCKET SHAFT C83780
- D — RAMMER CHAIN SPROCKET SHAFT SUPPORT C83781
- E — "WITHDRAW" STOP PIN A149904 AND LOCK PLATE A149903
- F — RAMMER HEAD (ASSEMBLY) D42583
- G — OIL EXPANSION TANK CONNECTION
- H — UNIVERSAL JOINT A22795 AND KEY BGHX1SD
- J — UNSTROKING DEVICE SHAFT B227213
- K — UNIVERSAL JOINT A22794 AND KEY BGHX1SD

- L — UNSTROKING DEVICE LIMIT ADJUSTING COUPLING (ASSEMBLY) - BODY 227210 - WORM WHEEL B227209 - ADJUSTING COUPLING WORM B227211 - RETAINER A262506 - NUT A262507 - AND TAPER PIN BFCX1CF
- M — (LOADING TROUGH BALANCE UNIT) SPRING 8160543
- N — CONTROL INTERLOCK SHAFT B127995 - NUT BBFX3A - WASHER A147037 - AND COTTER PIN BFAX2AB
- P — UNSTROKING GEAR CASE D46249
- Q — RAMMER HYDRAULIC SPEEDGEAR ("A" END) D42618
- R — BY-PASS VALVE D42636

RA PD 38800

Figure 110—Rammer Automatic Unstroking Device  
(Parking Tables Removed)

**DESCRIPTION AND FUNCTIONING****8. SAFETY PRECAUTIONS.**

a. The following safety precautions are enjoined upon all persons handling the gun, carriage and rammer:

(1) Be assured that the recoil parts lock (figs. 45 and 130) is in locked position at *all* times except when the gun is to be fired.

(2) Be assured that the lock is *open* when the gun is fired.

(3) Do not attempt to operate the various mechanisms of the gun, carriage and rammer by electric power until these mechanisms have been first operated by hand power to insure that they are in proper working order.

(4) If there is evidence of malfunctioning of any of the parts, do not persist in operating the parts until corrections have been made.

(5) Avoid excessive speed in traversing the mount when reaching the limits of traverse to avoid bringing the gun forcibly into contact with the emplacement.

(6) Do not use excessive speed when approaching the limits of elevation and depression to avoid undue shock to the moving parts.

(7) The using service will, under no condition, attempt repairs or adjustments of the elevating and traversing data receiver equipment. Any malfunction of these parts will be referred to the ordnance maintenance personnel.

(8) No attempt will be made to load the piece until it has been placed in proper loading position as indicated by inscribed lines on the right elevating rack and loading position pointer which must be in exact alinement.

(9) No attempt to load the piece will be made until the operator is assured that the forward end of the loading trough is resting on the bottom surface of the breech opening in the gun.

(10) The magnetos on the right and left sides of the mount should never be operated simultaneously.

(11) No attempt will be made to make repairs, alterations or corrections to any part of the electric power circuit without first disconnecting the power loop from one of the loop receptacles on either the racer or emplacement.

(12) No attempt will be made to repair or replace parts of the lighting circuit (except replacement of lamp bulbs), until current to the affected circuit has been shut off.

**16-INCH SEACOAST GUN MATERIEL  
GUN MK. II M1; BARBETTE CARRIAGE M4**

(13) The piece must never be fired until all personnel is clear of the path of recoil.

(14) The gun must not be elevated, either by hand or electric power, until the air and liquid pressures in the recuperators have been tested to insure that the gun will not slide through the cradle by gravity when elevated.

(15) The elevating trunnion antifriction device must show a clearance of exactly 0.008 inch between the trunnions and trunnion bearings before any attempt is made to elevate or depress the gun, either by hand or motor power.

(16) The elevating brake bands must grip the brake drums with sufficient power to prevent any tipping movement of the gun and cradle when the piece is fired. A test of this condition may be made by attempting to elevate by hand, with the brake levers in horizontal position.

DESCRIPTION AND FUNCTIONING

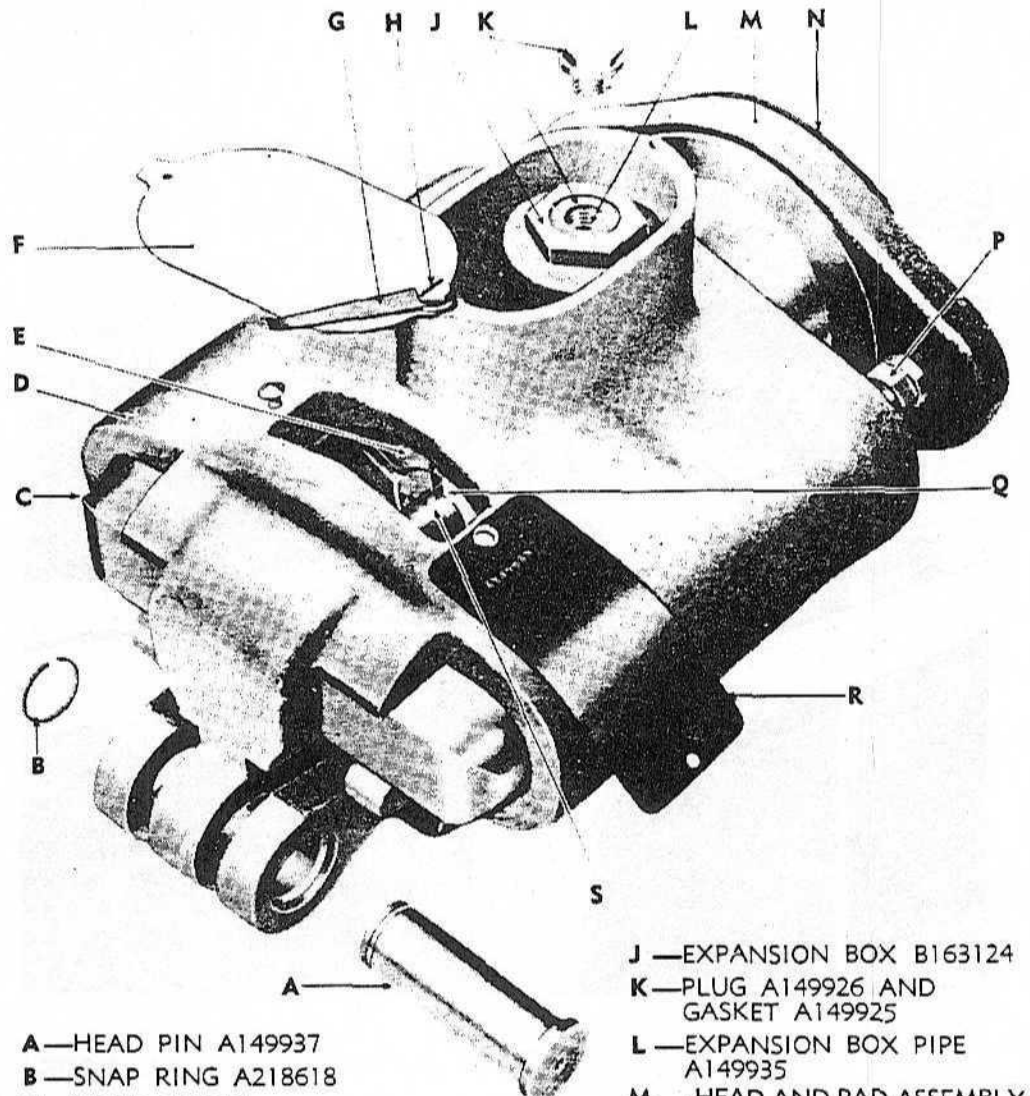

- A—HEAD PIN A149937
- B—SNAP RING A218618
- C—YOKE C54915
- D—RAMMER HEAD CYLINDER D42584
- E—RAMMER HEAD BUSHING B187540
- F—RAMMER HEAD CYLINDER COVER B163125
- G—COVER SPRING A149928
- H—SCREW A149927 WITH WASHER BEBX1F AND PIN BFDX8.1T

- J—EXPANSION BOX B163124
- K—PLUG A149926 AND GASKET A149925
- L—EXPANSION BOX PIPE A149935
- M—HEAD AND PAD ASSEMBLY
- N—PAD A149934 AND RIVET BMAX2
- P—SPRING PLUNGER B187542
- Q—PISTON GLAND A218609 AND PACKING A218610
- R—RAMMER HEAD COVER A149933 AND SCREW BCNX2AC
- S—PISTON B163104

RA PD 38801

Figure 111—Rammer Head

**16-INCH SEACOAST GUN MATERIEL  
GUN MK. II M1; BARBETTE CARRIAGE M4**

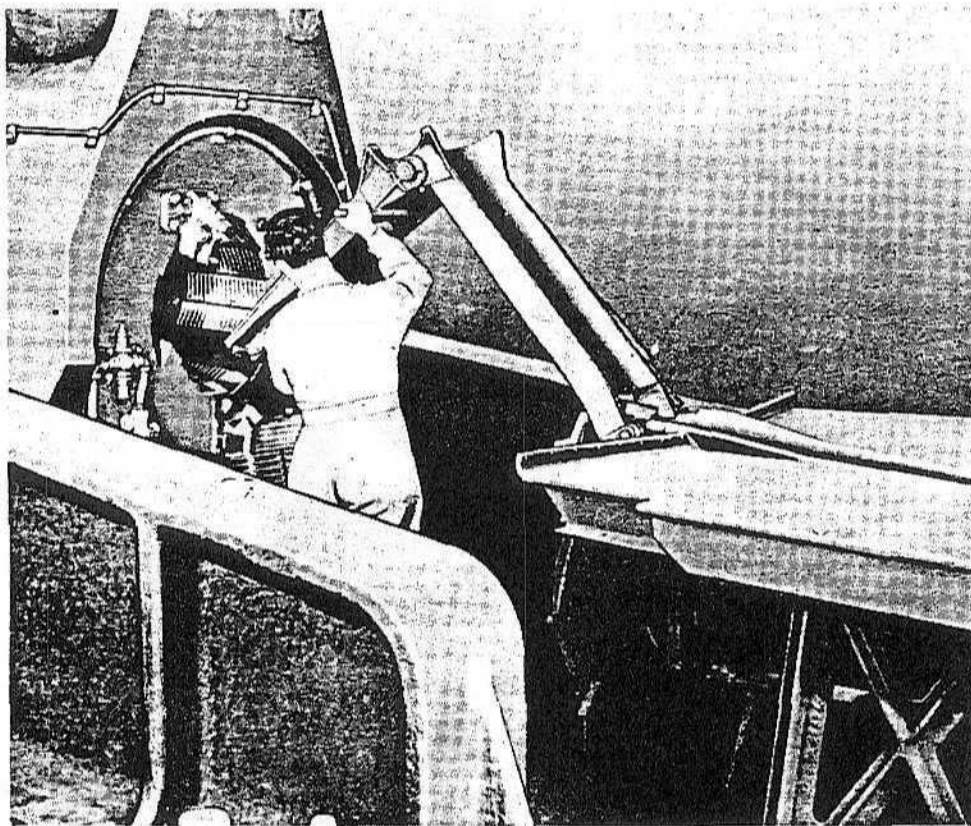

RA PD 38802

**Figure 112—Extending Loading Trough into Breech Opening**

**DESCRIPTION AND FUNCTIONING**

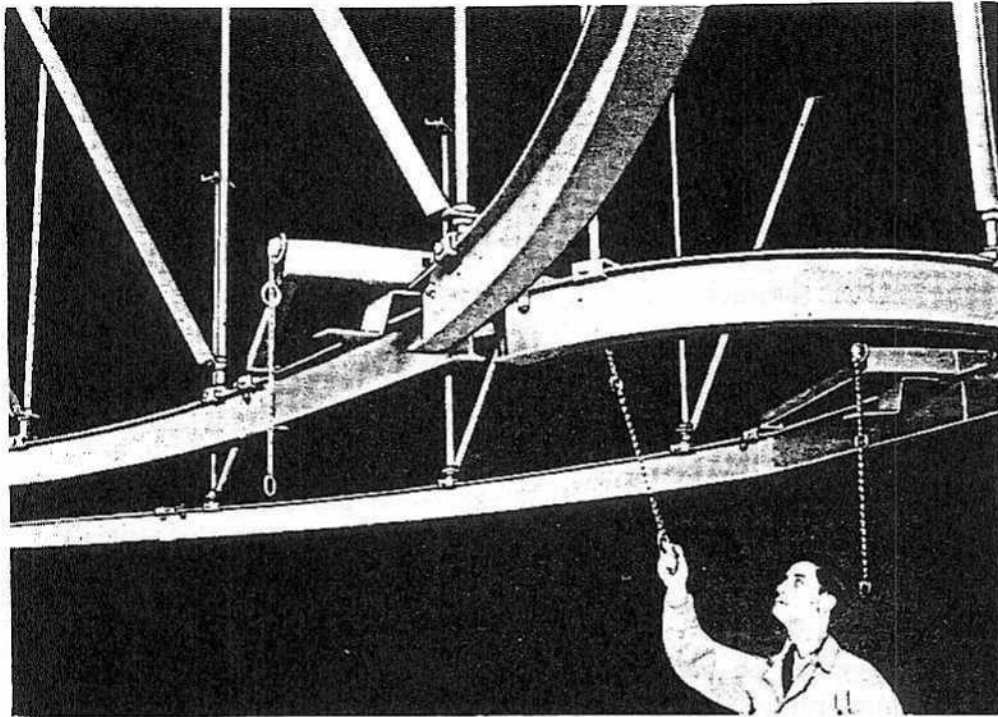

RA PD 38803A

**Figure 113—Operating Switch in Overhead Trolley**

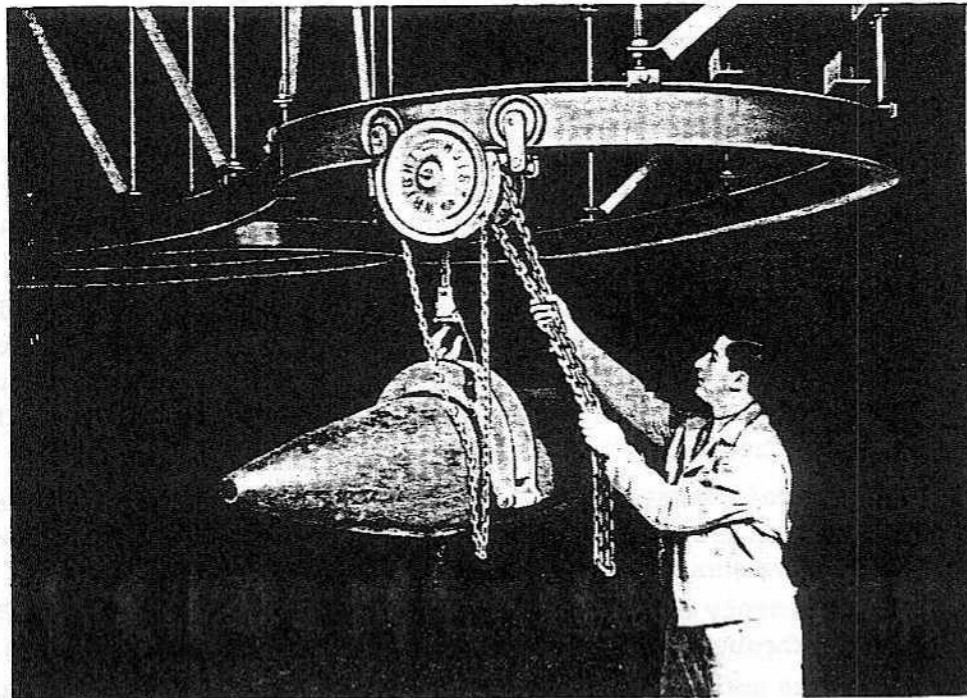

RA PD 38803

**Figure 113-1—Hoist on Overhead Trolley with Dummy Projectile**



**16-INCH SEACOAST GUN MATERIEL  
GUN MK. II M1; BARBETTE CARRIAGE M4**

**Section III  
OPERATION**

	Paragraph
Operation of the gun and carriage.....	9
Operation of the rammer.....	10

**9. OPERATION OF THE GUN AND CARRIAGE.**

a. Prepare the piece for action in accordance with the following procedure:

(1) **RECOIL PARTS LOCK.** See that the recoil parts lock (fig. 45) is assembled with the nut (A, fig. 45) securely screwed onto the stud (F, fig. 45).

**b. Preparing the Gun.**

(1) Remove breech and muzzle covers. Lubricate all moving parts of the gun and mount in accordance with requirements as outlined in Lubrication Guide. See that all oil reservoirs or retainers are supplied with sufficient quantities of proper lubricant.

(2) **REMOVING COMPOUND, RUST PREVENTIVE.** Remove all COMPOUND, rust preventive, from gun breech, breech mechanism parts and other exposed finished surfaces of the gun and carriage.

(3) **CLEANING BREECH MECHANISM.** Open the breechblock by releasing the operating lever latch (X, fig. 14) from the upper end of the breech operating lever (F, fig. 13) bringing the carrier to full open position (fig. 10). Complete the operation of thoroughly cleaning all parts of the breech mechanism. Particular care must be exercised to insure that the channel through the obturator spindle (J, fig. 11) is free from oil, grease, or dirt of any kind.

(4) **CLEANING GUN BORE.** Using the bore scraper, bore sponge and chamber sponge, remove all preserving compound and oil from the bore and powder chamber of the gun (fig. 10). Clean the bore and chamber with a soda and water solution as prescribed, and thoroughly dry all interior parts of the gun.

(5) **OPERATING BREECH MECHANISM.** After ascertaining that the air compressor is in proper working condition as outlined in d, below, the breech mechanism should be operated in the following manner:

(a) Test efficiency of the compressed air system by first shutting off the flow of air through the breech closing valve (fig. 26, and Y, fig. 13).

(b) Open the gas ejector valve (fig. 25, and R, fig. 13) to permit flow of air into gun breech.

(c) Close gas ejector valve and open the closing valve gradually, allowing air to enter the closing cylinders slowly to avoid too rapid closing of the breech mechanism.

## OPERATION

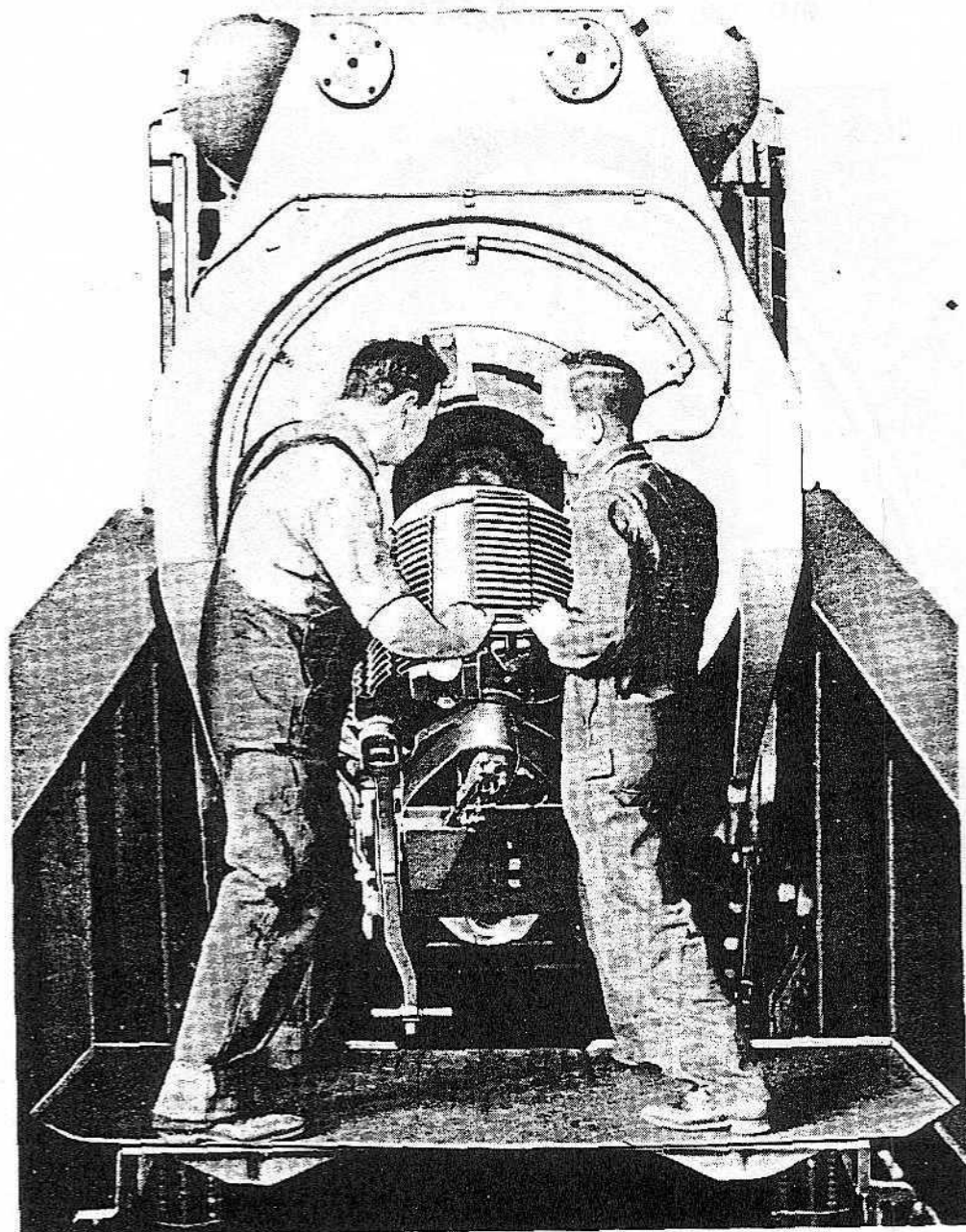

RA PD 38804

**Figure 114—Closing the Breech—Manually**

(6) AIR REDUCING AND CLOSING VALVES. The volume of air entering the cylinders is controlled by the air reducing valve (fig. 24, and W, fig. 23) and the closing valve (Z, fig. 23, and Y, fig. 13). Check the operation of the closing and air reducing valves to insure smooth working of the breechblock carrier during the operation of closing the breechblock.

(a) Should adjustment of the air reducing valve be necessary, it will be noted that turning the adjusting screw at the upper end of the valve

**16-INCH SEACOAST GUN MATERIEL  
GUN MK. II M1; BARBETTE CARRIAGE M4**

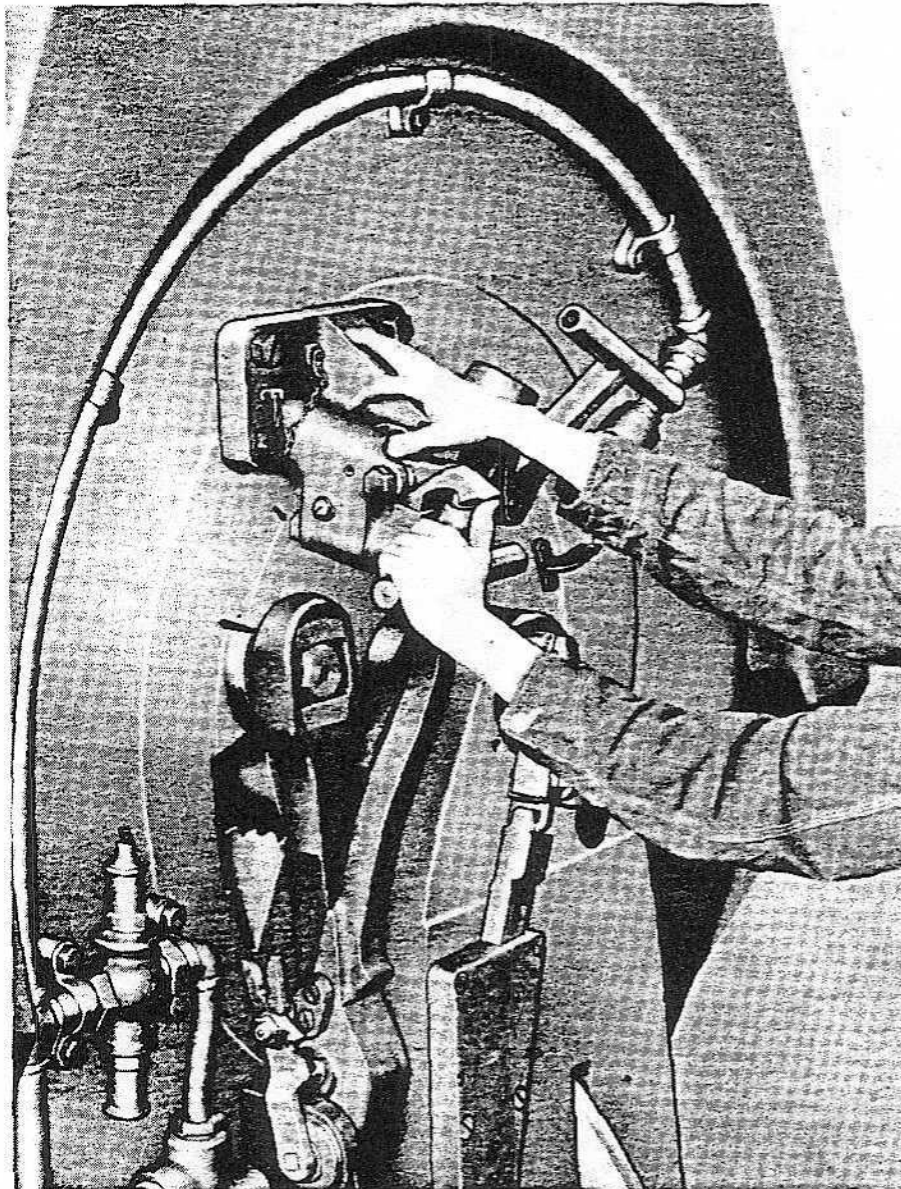

RA PD 38681

**Figure 115—Unlatching the Breech Operating Lever**

clockwise increases the flow of air to the closing cylinders. Turning the screw counterclockwise reduces the flow of air to the cylinders and slows down the speed of the carrier in the breech closing movement.

(b) Before opening the closing valve ascertain that there will be no interference to free action of the carrier as it moves into closed position.

(c) In the event of failure of the air pressure to properly operate, two men (fig. 114) working together can close the block by hand power.

**OPERATION****(7) OPENING BREECHBLOCK.**

(a) To open the breechblock press the salvo latch inward to disengage the operating lever latch and press the operating lever latch upward to disengage the operating lever (fig. 115). A downward pull on the operating lever causes the breechblock to rotate, thus disengaging the threads of the block from their seat in the gun breech. The block should then be carefully lowered to its full open position. It is advisable to open and close the block several times by hand before applying air power in order to insure free operation of the moving parts. When gases and debris have been ejected close the gas ejector valve to avoid drain on the air compressor system.

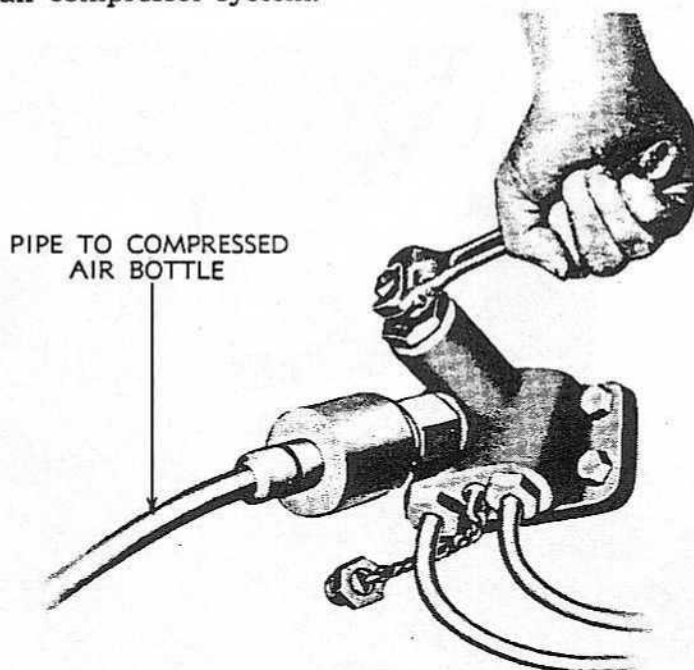

RA PD 38805

**Figure 116—Operating Maneuvering Valve**

(b) The closing cylinder spring assembled on the right plunger rod (F, fig. 22), when properly adjusted, so balances the weight of the carrier and block as to make possible the opening of the breechblock by one man.

c. **Firing Lock.** Examine the firing lock and make sure that it contains no damaged primer or foreign matter of any kind before assembling it to the rear of the obturator spindle (J, fig. 11). Assemble the firing lock to the spindle and connect the lock operating bar (fig. 21, and C, fig. 19) to the firing lock slide (W, fig. 29). Test the operation of the lock by manipulating the operating lever to insure smooth working of the firing lock mechanism.

d. **Preparing the Carriage for Action.** Prepare the carriage for action in accordance with the following procedure:

(1) **AIR PRESSURE IN RECUPERATORS.** Check the air pressure in the

**16-INCH SEACOAST GUN MATERIEL  
GUN MK. II M1; BARBETTE CARRIAGE M4**

recuperator cylinders. If the air pressure gage at the liquid pump (E, fig. 44, and J, fig. 55) indicates a pressure below 1,700 pounds per square inch, proceed in the following manner to bring the pressure to 1,700 pounds:

(a) With all three recuperator cylinders filled with liquid remove plug (L, fig. 56) from the maneuvering valve (B, fig. 44) located on the cradle near the left trunnion bearing.

(b) Attach air filling device (fig. 116) which is connected to the portable compressed air cylinder.

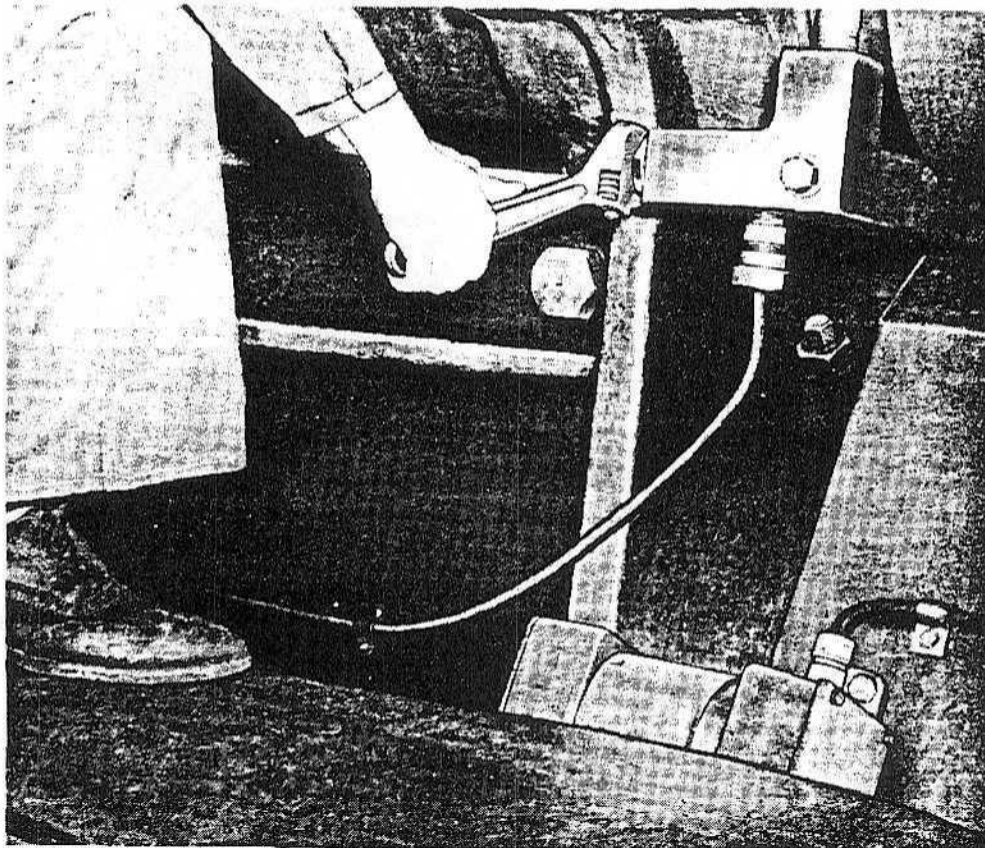

RA PD 38806

**Figure 117—Operating Recuperator Air Manifold Valve**

(c) Open valve stem (J, fig. 56) in maneuvering valve body and unscrew the air valve in the recuperator manifold (fig. 117) about seven turns (approximately one-half inch) to permit a flow of air from the portable air cylinder to the recuperator cylinders.

(d) Now slowly open the valve in the portable air cylinder allowing the air to pass into the recuperator cylinders without excessive force.

(e) Observe reading on air pressure gage. If the air gage hand comes to rest, the air pressure in the portable cylinder and the recuperators will be equal and no further pressure can be obtained from the portable cylinder under these conditions.

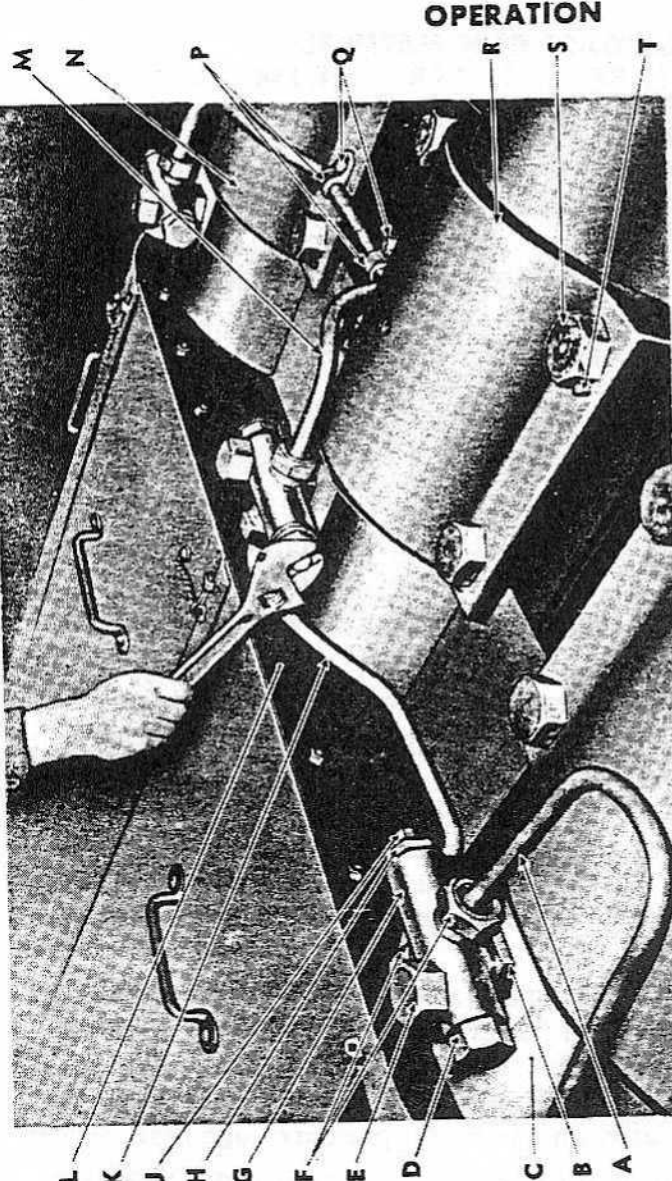

**OPERATION**

- A—TUBING (ASSEMBLY) B187288
- B—VALVE BODY GLAND A218091
- C—RECUPERATOR CYLINDER D42396
- D—GRAVITY FILLING VALVE (ASSEMBLY) A218116
- E—GRAVITY FILLING INLET CAP A218092 AND GASKET A218093
- F—NUT A218103 AND PIPE COLLAR A218119
- G—LIQUID VALVE BODY (ASSEMBLY) B162597 AND GASKET A218090
- H—PRESSURE FILLING VALVE PACKING GLAND A218099—PACKING A218100 AND FOLLOWER A218096
- J—PRESSURE FILLING VALVE (ASSEMBLY) A218115
- K—TUBING (ASSEMBLY) B162370

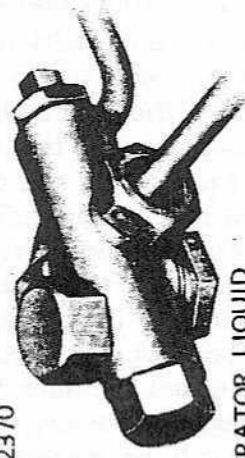

RECUPERATOR LIQUID VALVE (ASSEMBLY) C87139

- L—PLUNGER COVER (ASSEMBLY) D42638
- M—TUBING (ASSEMBLY) B187172
- N—RECUPERATOR CYLINDER OUTER STRAP C87187
- P—PIPE CLIP A218121
- Q—SCREW BCAXICA AND LOCK WASHER BECXIK
- R—RECUPERATOR CYLINDER CENTER STRAP C87188
- S—BOLT B187205B
- T—LOCK SCREW A218104

RA PD 38733

**Figure 118—Operating Pressure Filling Valve**

**16-INCH SEACOAST GUN MATERIEL  
GUN MK. II M1; BARBETTE CARRIAGE M4**

(f) Close valve in the maneuvering valve body (fig. 116) and the valve on the portable cylinder.

(g) Disconnect the filling device from the empty cylinder and attach it to a full cylinder.

(h) Reopen the valve in the maneuvering valve body (fig. 116) and continue to repeat this operation until the air pressure gage (J, fig. 55) shows a pressure of 1,700 pounds per square inch.

(i) The piston rod nut washer (U, fig. 50) should now coincide with the zero markings on the liquid indicators (AP, fig. 50) and the liquid pressure gage (W, fig. 55) at the liquid pump should show a reading of 1,842 pounds per square inch.

(j) When this condition is evidenced the air and liquid pressure in the cylinder will be in balance.

(k) Now close all valves, remove the filling device and replace maneuvering valve plug (L, fig. 56).

(l) To replenish pressures in the recuperator cylinders made necessary by escape of air or in the initial filling of the cylinders the procedure outlined above will be followed.

**e. Filling and Replenishing Recuperator Cylinders with Liquid.** Having in mind the necessity of keeping the prescribed quantity of liquid in the cylinders at all times, air pressure will not be applied until the cylinders have been filled with liquid. The same liquid is to be used as is used in the recoil cylinder.

(1) **LIQUID PRESSURE IN RECUPERATORS.** Examine recuperator liquid gage (W, fig. 55) at the liquid pump to ascertain that the pressure registers 1,842 pounds per square inch. If the pressure is below the prescribed reading of 1,842 pounds the liquid pump will be operated until the required pressure is indicated on the liquid pressure gage dial.

(a) Examine the position of the recuperator piston rods. With air pressure of 1,700 pounds and liquid pressure of 1,842 pounds the circumferential line on the piston rod nut washer (U, fig. 50) should coincide with zero marking on the graduated liquid indicator (AP, fig. 50) attached to each piston rod outer gland (AN, fig. 50). Should there be any variation in the longitudinal position of the piston rods it indicates a lack of uniform liquid pressure in the recuperator cylinders. To correct this condition check the liquid pressure in each individual recuperator cylinder separately by opening the pressure filling valve (J, fig. 118) in the valve body of each recuperator. This will allow the liquid pressure in each individual cylinder to register on the liquid pressure gage. If the liquid pressure is below 1,842 pounds per square inch in any cylinder, the pressure will be increased by means of the liquid pump until all cylinders show pressure of 1,842 pounds per square inch.

(b) The liquid pump (D, fig. 44) and (fig. 55) is used to replenish the liquid supply in the three recuperator cylinders and will be operated to replenish each one of the recuperator cylinders independently.

### OPERATION

(c) To replenish liquid in the recuperator cylinders remove the filling cap (D, fig. 55) in the pump cover, fill the pump with liquid (fig. 119) and replace the cap. Then open the pressure valve (fig. 118), attached to the particular cylinder to be filled, by backing off the valve stem approximately three-quarters of an inch (six turns). Now apply pressure by operating the lever of the liquid pump forcing liquid into the recuperator cylinder until the index mark on the piston rod nut

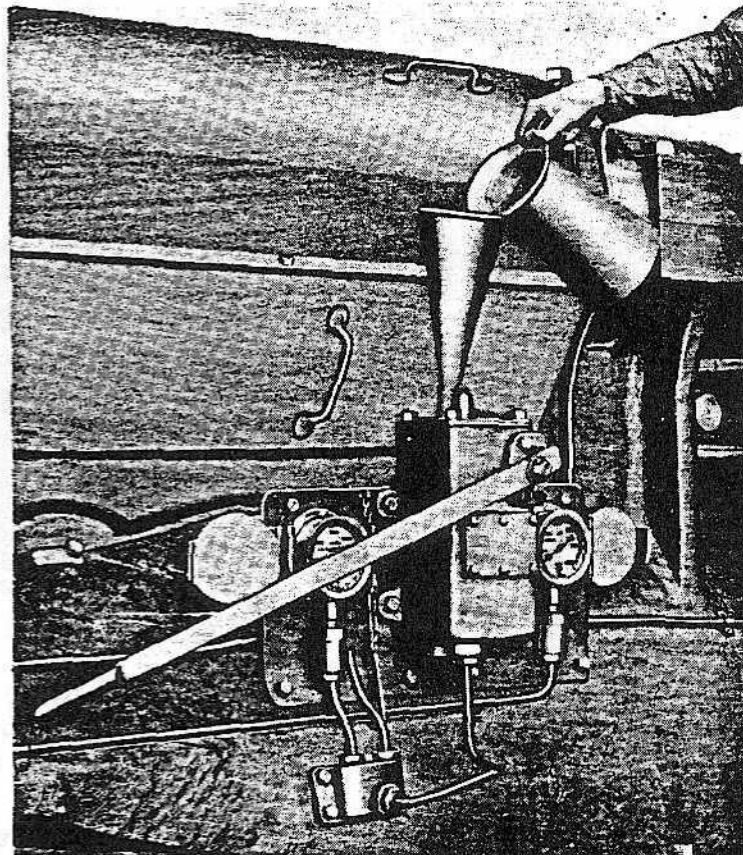

RA PD 38807

**Figure 119—Filling Liquid Pump**

washer (U, fig. 50) is opposite "0" on the liquid indicator (AP, fig. 50). At this setting the liquid pressure gage should register 1,842 pounds. Repeat this operation on each cylinder, with valves on the remaining two cylinders closed, until all cylinders show pressure of 1,842 pounds.

(d) When opening the pressure valves (J, fig. 118) for replenishing recuperator cylinders with liquid **DO NOT OPEN** the hexagon head gravity filling valve (D, fig. 118) **OR REMOVE** cap (E, fig. 118) while the recuperators are under pressure, as the hexagon head filling valve and cap are for gravity filling only.

(e) The piston rod nut washer (U, fig. 50) should never be allowed to bear against the outer gland (AN, fig. 50). So long as a one-half inch space is maintained between these parts the floating piston and rod will be in balance and will have no tensile stress brought upon them.

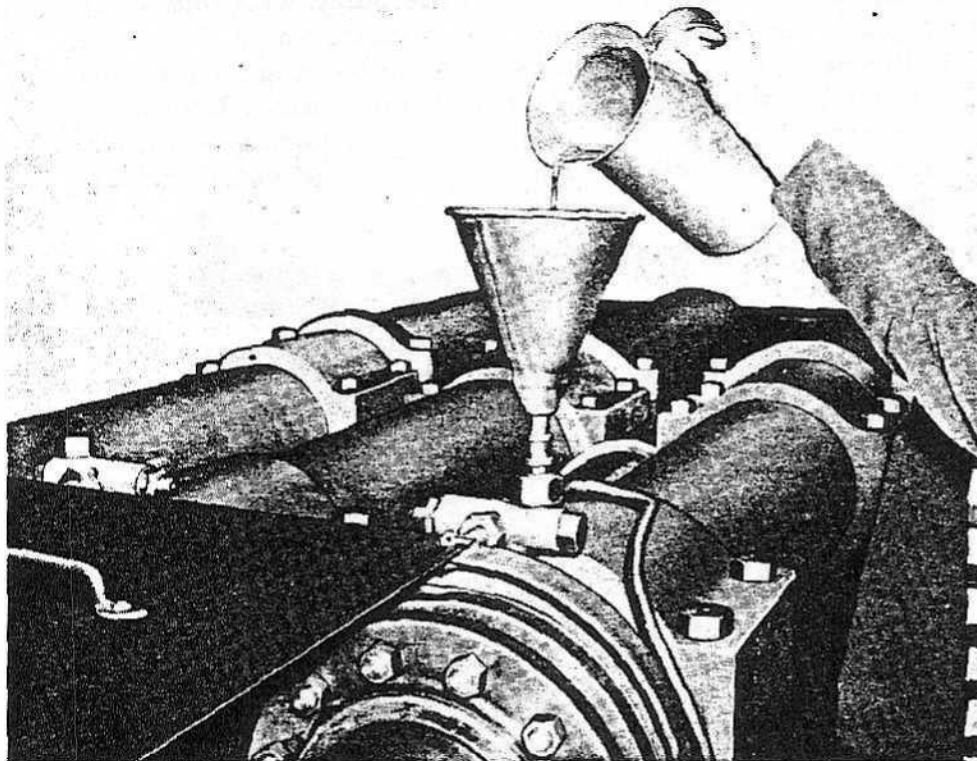

**16-INCH SEACOAST GUN MATERIEL  
GUN MK. II M1; BARBETTE CARRIAGE M4**

RA PD 38808

**Figure 120—Filling Recuperator Cylinder with Liquid by Gravity**

(f) Pressure of liquid in any recuperator cylinder should never be permitted to fall below a point where the piston rod nut washer moves to the front a distance greater than five inches from the face of the outer gland.

(g) Initial filling of recuperator cylinders (fig. 120) with liquid will be done in accordance with the following procedure:

1. With *no* compressed air in the cylinders and with recuperator assembled at 2-degree depression, set piston rod so that the marking on the piston rod nut washer (U, fig. 50) coincides with graduation marked zero on liquid indicator (AP, fig. 50).

2. Remove dust guards that house the recuperator mechanism.

3. Remove cap from valve body (G, fig. 118) and attach special filling device designed for filling cylinders with liquid. (This device is carried in the armament chest.) Unscrew filling valve (D, fig. 118) about one-half inch (approximately seven turns) and pour liquid into funnel (fig. 120).

4. In filling the recuperator cylinder with liquid, the liquid should be poured into the funnel gradually to permit the air to escape past the stream of liquid while the cylinder is being filled (fig. 120). After filling, allow sufficient time for all air to escape from the cylinder before closing the valve stem.

5. Each cylinder will be filled individually in the same manner.

OPERATION

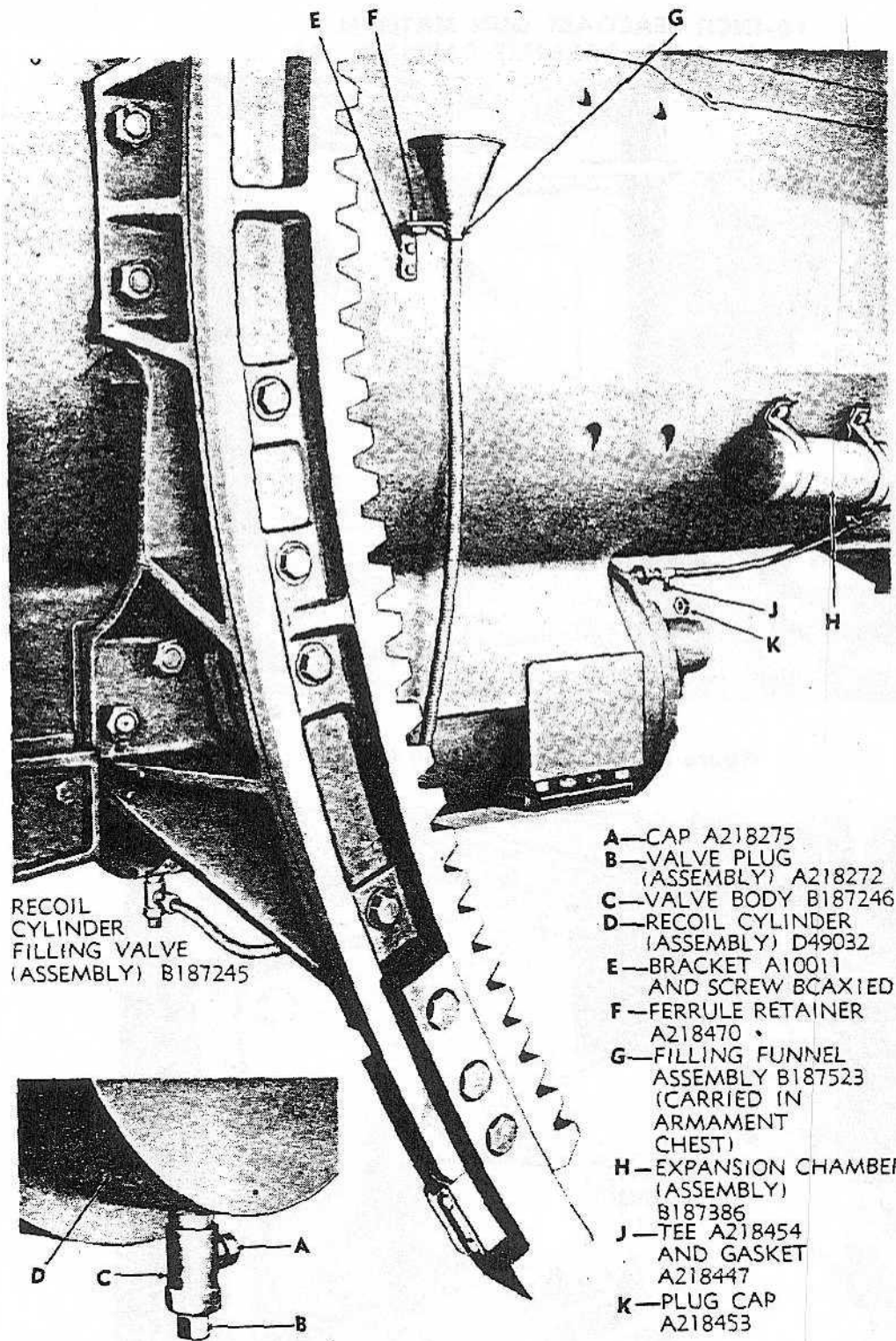

RECOIL CYLINDER FILLING VALVE (ASSEMBLY) B187245

- A—CAP A218275
- B—VALVE PLUG (ASSEMBLY) A218272
- C—VALVE BODY B187246
- D—RECOIL CYLINDER (ASSEMBLY) D49032
- E—BRACKET A10011 AND SCREW BCAX1ED
- F—FERRULE RETAINER A218470
- G—FILLING FUNNEL ASSEMBLY B187523 (CARRIED IN ARMAMENT CHEST)
- H—EXPANSION CHAMBER (ASSEMBLY) B187386
- J—TEE A218454 AND GASKET A218447
- K—PLUG CAP A218453

RECOIL CYLINDER FILLING VALVE (ASSEMBLY) B187245

RA PD 38725

Figure 121—Recoil Cylinder Filling Device

**16-INCH SEACOAST GUN MATERIEL  
GUN MK. II M1; BARBETTE CARRIAGE M4**

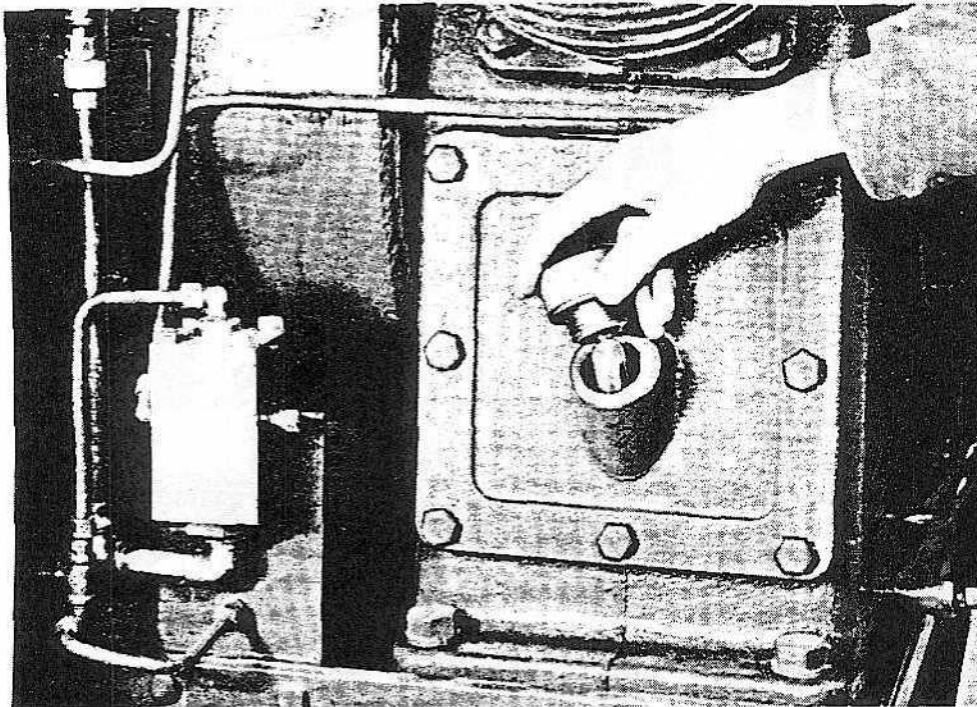

RA PD 38810A

**Figure 122-1—Removing the Oil Cap**

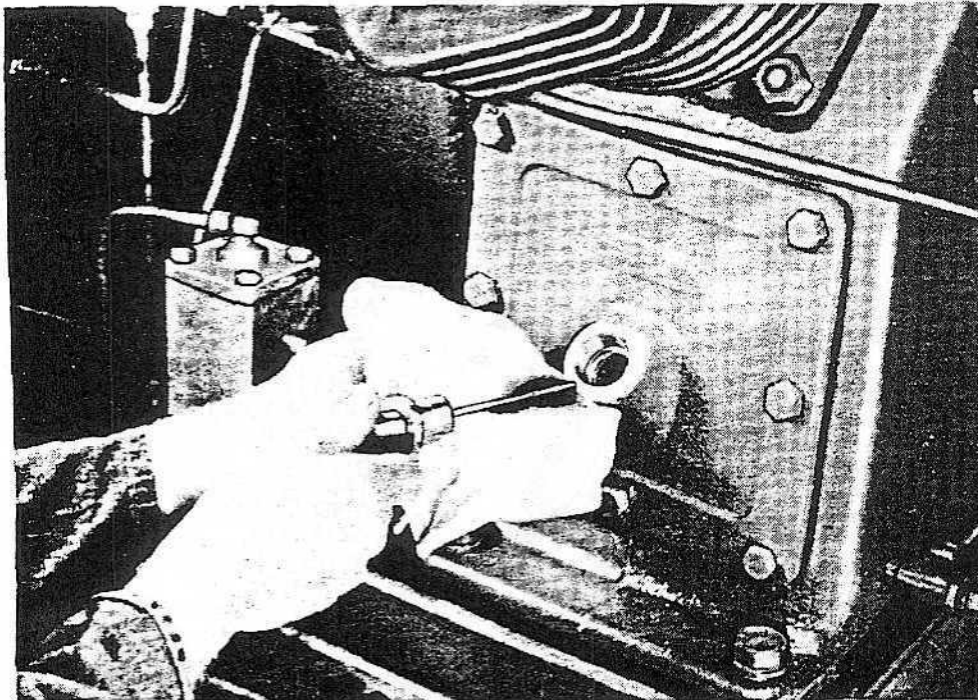

RA PD 38810

**Figure 122-2—Wiping Off Oil Gage with a Clean Rag Before  
Reading the Oil Level**

OPERATION

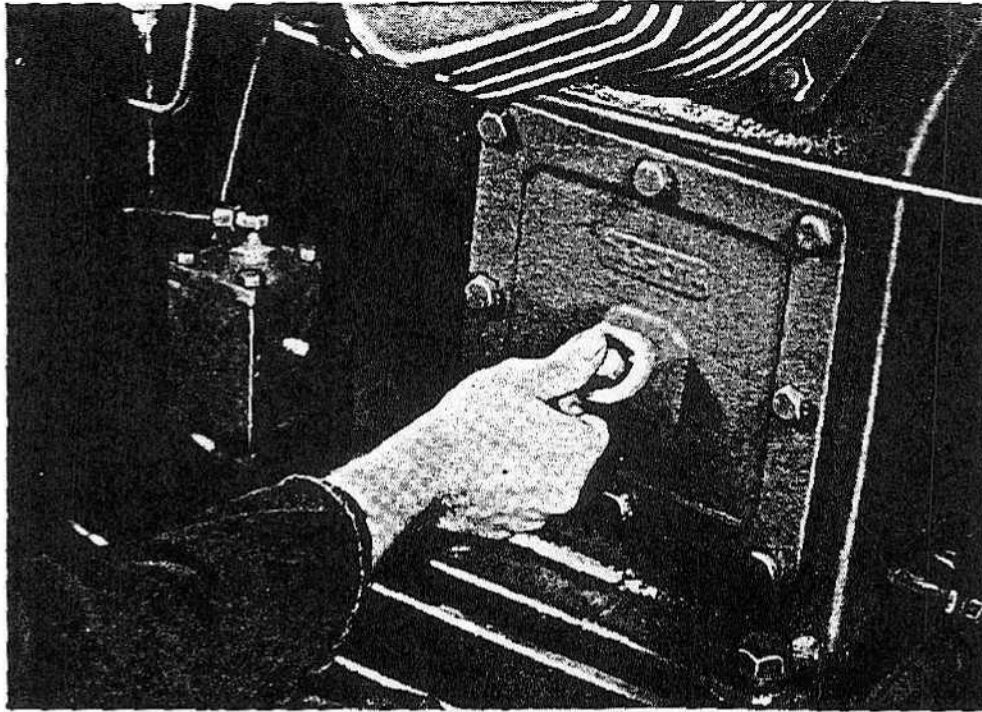

RA PD 38809A

Figure 122-3—Pressing Down Oil Gage for Proper Oil Level Reading

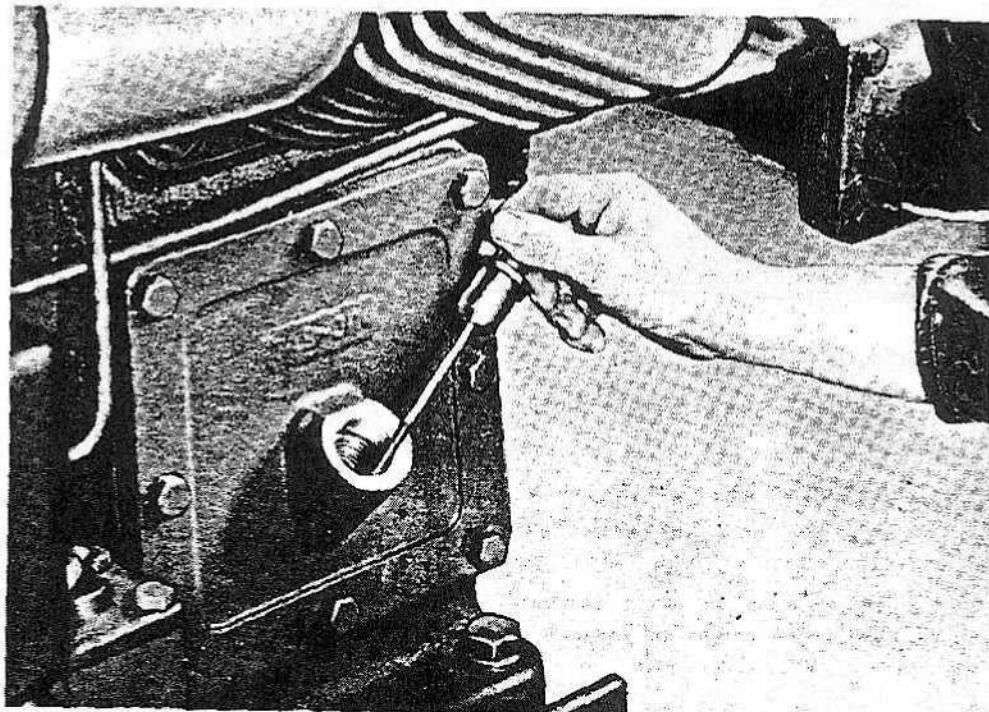

RA PD 38809

Figure 122-4—Reading Oil Level Gage

16-INCH SEACOAST GUN MATERIEL  
GUN MK. II M1; BARBETTE CARRIAGE M4

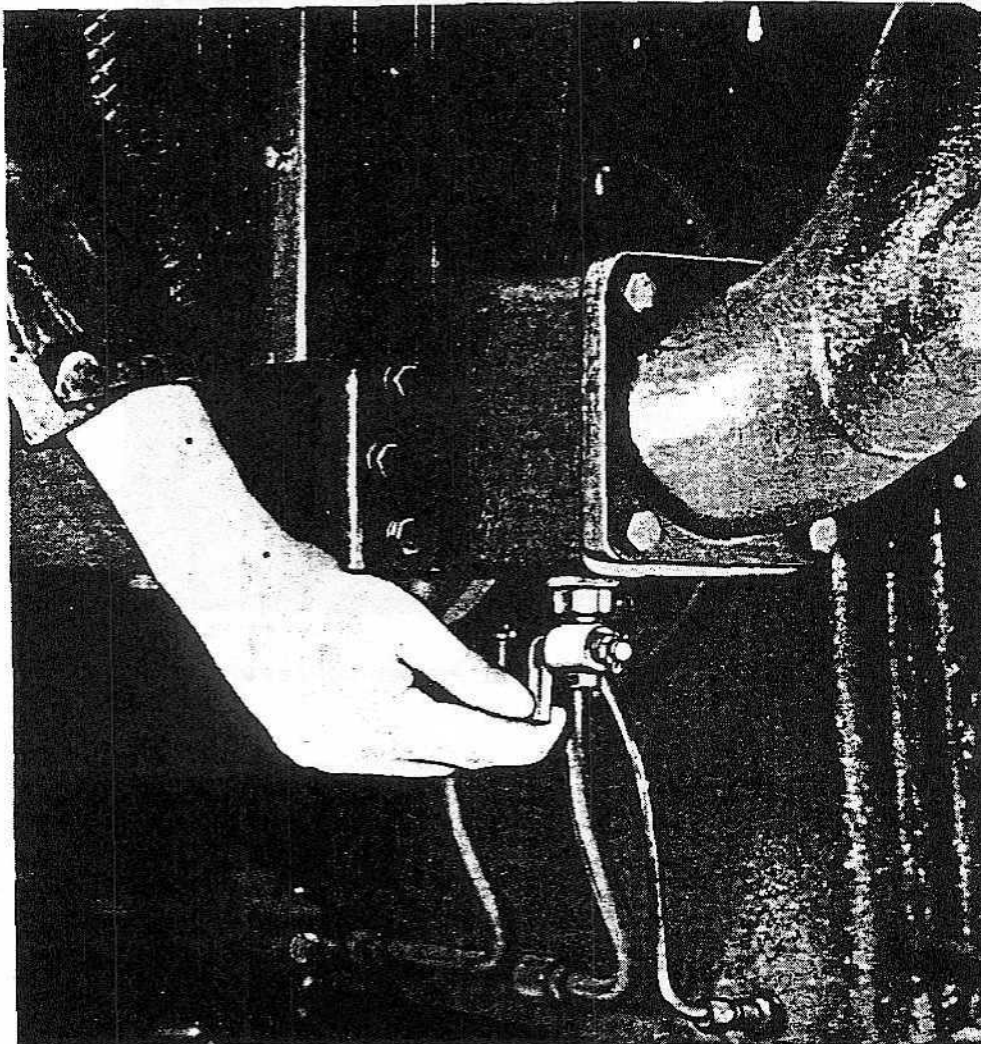

RA PD 38811

**Figure 123—Operating Interstage Cooler Drain Cock—Air Compressor**

6. When filled the three recuperator cylinders contain 27 gallons of liquid.

**f. Filling Recoil Cylinder.** Check liquid in recoil cylinder to ascertain that the cylinder is filled with fluid. This may be determined by removing the plug cap (K, fig. 121) from the tee (J, fig. 121) in the expansion chamber pipe. If there is no overflow of liquid from the tee it will indicate that the cylinder may not be completely filled. If there is a deficiency of fluid proceed to replenish the liquid in the cylinder in accordance with the following procedure:

- (1) Set the gun at 2-degree elevation.
- (2) Remove the filling valve cap (A, fig. 121). Attach the filling device (G, fig. 121) to valve body (C, fig. 121). The funnel end of the device is supported by bracket (E, fig. 121).

**OPERATION**

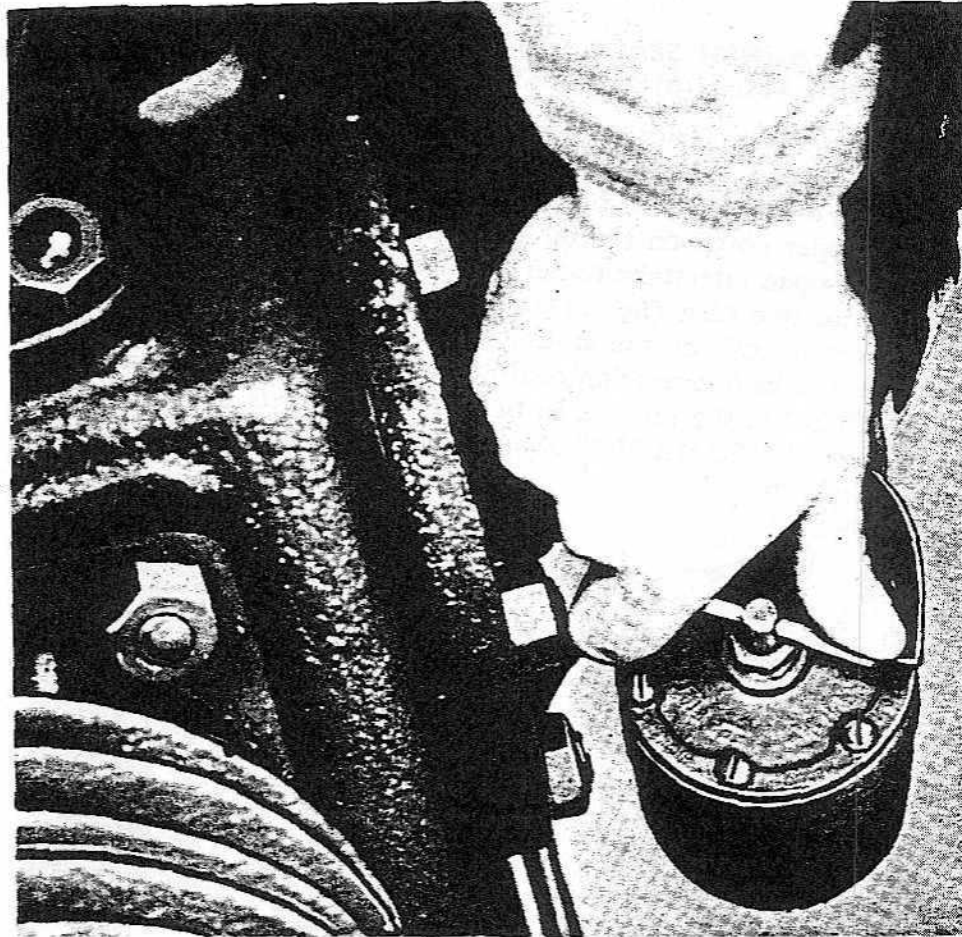

RA PD 38812

**Figure 124—Operating Oil Filter Agitator  
(One Complete Turn After Each Shut-down)**

- (3) Unscrew the valve plug (B, fig. 121) about nine turns, or approximately three-quarters of an inch.
- (4) Remove the plug cap (K, fig. 121) to allow the air to escape from the recoil cylinder.
- (5) Pour the liquid into the funnel of the filling device until the liquid flows out of tee (J, fig. 121).
- (6) Close the valve plug (B, fig. 121) and replace the plug cap.
- (7) Remove the filling device and replace filling valve cap.
- (8) The capacity of the recoil cylinder is 73 gallons.
- (9) The following mixture will be used in the recoil mechanism:
  - 60 parts by volume GLYCERIN, grade A, USP.
  - 40 parts by volume distilled water.

To each three gallons of the mixture, add one ounce of SODIUM HYDROXIDE, CP(NaOH) sticks or pellets (one pound SODIUM HYDROXIDE to 48 gallons). Caustic soda (lye) must not be used.

**16-INCH SEACOAST GUN MATERIEL  
GUN MK. II M1; BARBETTE CARRIAGE M4**

g. **Air Compressor.** Before starting the air compressor ascertain the level of the oil in the air compressor crankcase by using oil gage (fig. 122). If there is a deficiency of oil, replenish until the oil reaches height indicated by upper notch on the oil gage. Close interstage cooler drain cock (fig. 123), open interstage cooler vent cock (L, fig. 58). Rotate the oil filter agitator one turn (fig. 124). Now press the starting button at the air compressor push-button station (B, fig. 155). If it is anticipated that the piece is to be in operation continuously, press the button marked "CONTINUOUS." If the piece is to be held in readiness for action, the button marked "AUTOMATIC" should be operated. After the motor

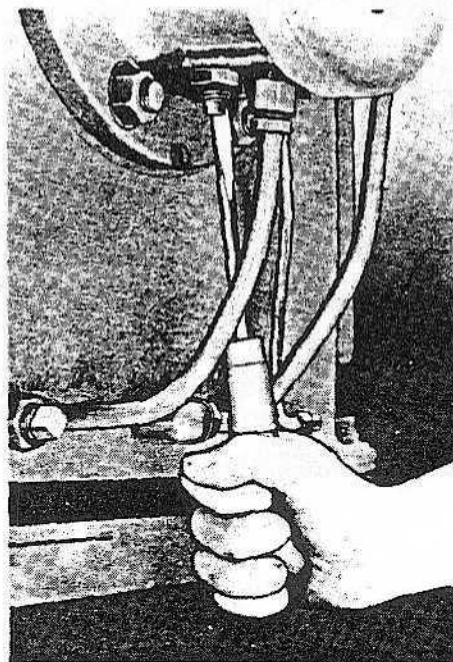
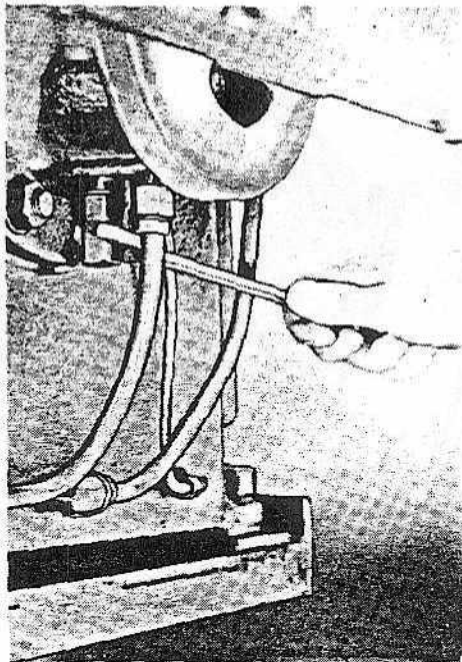

RA PD 38813

**Figure 125—Removing Dust Cap**      **Figure 126—Adjusting Oil Pressure**  
—Air Compressor                              —Air Compressor

has been in operation for approximately 10 minutes examine air gage (B, fig. 60) to see that the air pressure registers between 135 and 155 pounds per square inch. Examine the oil pressure gage (J, fig. 66) to insure that proper lubrication for the compressor parts is being maintained. The gage pointer should indicate pressure at 30 to 35 on the dial. If oil pressure gage shows less than minimum pressure the matter should be called to the attention of the ordnance personnel who will make adjustments as indicated in figures 125 and 126.

(1) The interstage cooler vent cock (L, fig. 58) must be in open position when the compressor is operating automatically. The cock may be closed when the compressor is operating continuously.

(2) If there is leakage at the relay valves (K and S, fig. 58), the unloader fingers (fig. 65) will fail to release the three intake valves (fig. 65) and pumping action will not be reestablished at the prescribed

## OPERATION

pressure drop. When this occurs, the magnetic unloader plunger should be pressed down several times (fig. 128). This action discharges the air in the unloading system air reservoir (fig. 64) through the relay valves. The freely escaping air will clean the valve seats (fig. 63) and stop the leak.

(3) The condition of the oil in the compressor crankcase must be checked frequently. When the condition of the oil becomes unsatisfactory as outlined in the specifications of the Lubrication Guide, the oil is drained from the crankcase by removing the drain plug (R, fig. 58) and (fig. 127).

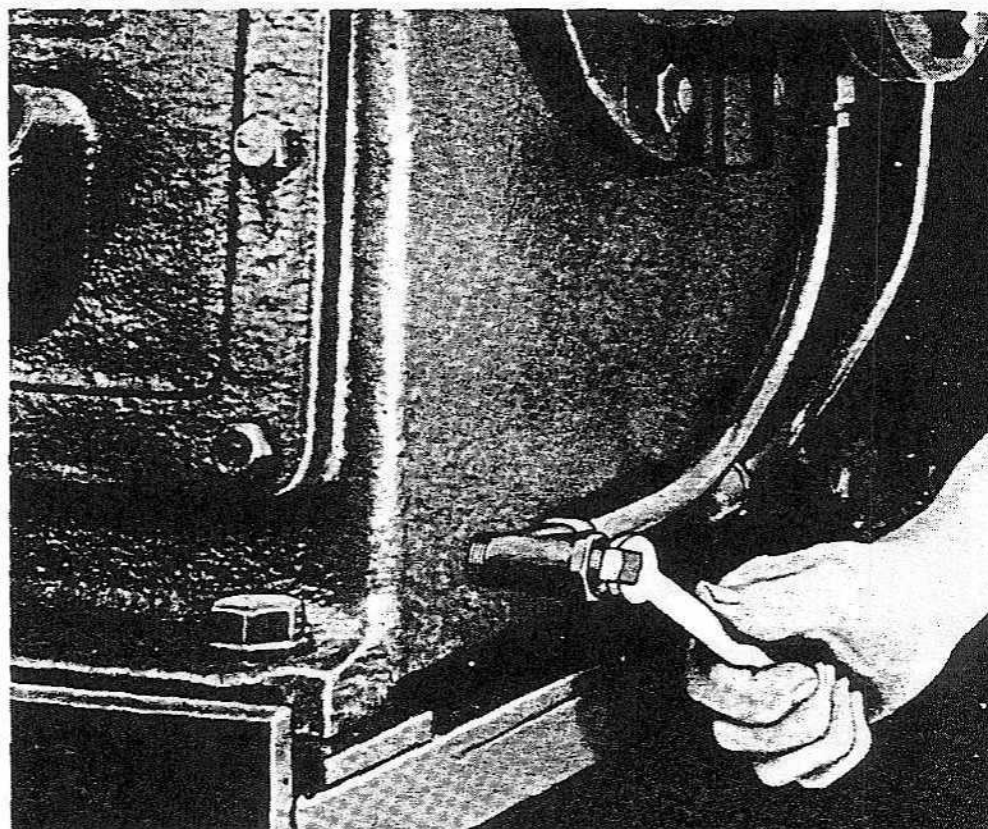

RA PD 38814

**Figure 127—Removing Crankcase Drain Plug—Air Compressor**

(4) A safety valve (B, fig. 66) protects the interstage cooler against excessive pressure and should be kept in working order by opening it daily when the machine is running.

(5) If the air pressure cannot be maintained between the limits of 135 pounds and 155 pounds, the matter should be called to the attention of the ordnance personnel. Figure 128 indicates the adjustment of the pressure limits.

(6) The air is drawn into each low pressure stage cylinder through an intake air filter (F, fig. 58). These air filters must be examined frequently to ascertain that they are not clogged with foreign matter. When this occurs the filter elements should be removed as indicated in figure



16-INCH SEACOAST GUN MATERIEL  
GUN MK. II M1; BARBETTE CARRIAGE M4

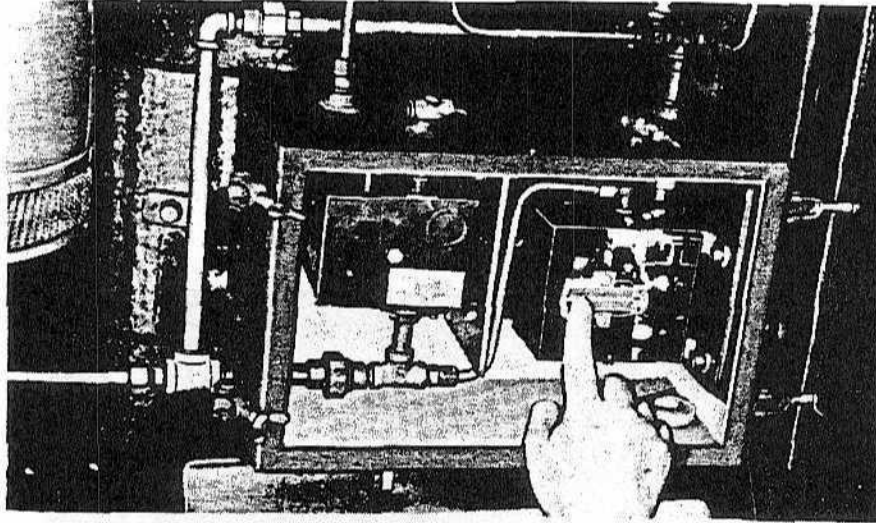

RA PD 38815

Figure 128-2—Pressing in Plunger of  
Magnetic Unloader

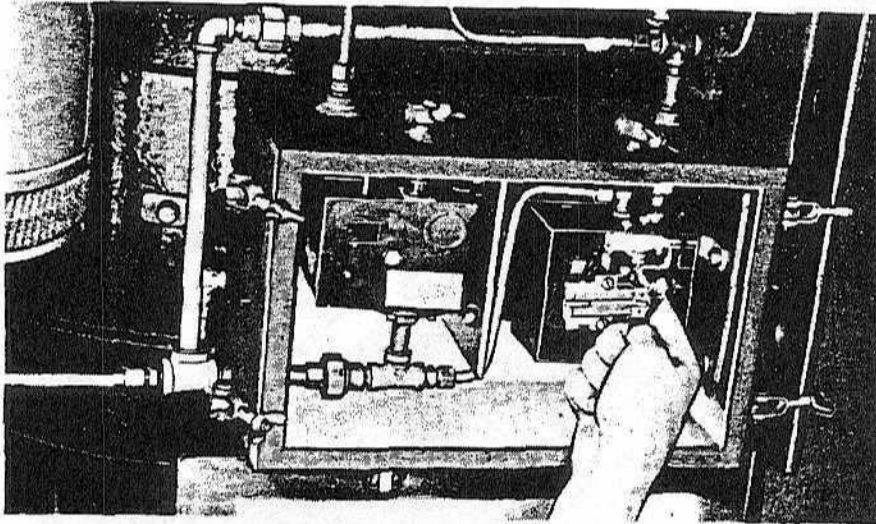

Figure 128-1—Making Pressure  
(Cut-in) Adjustment

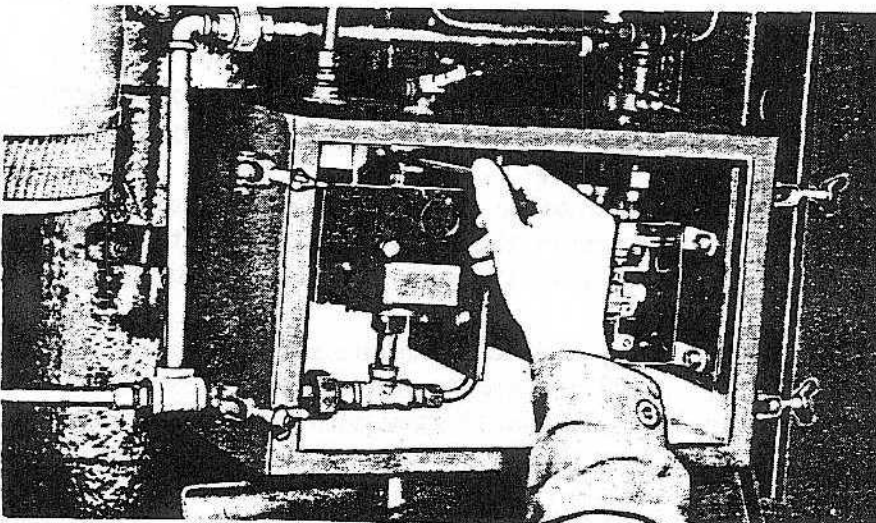
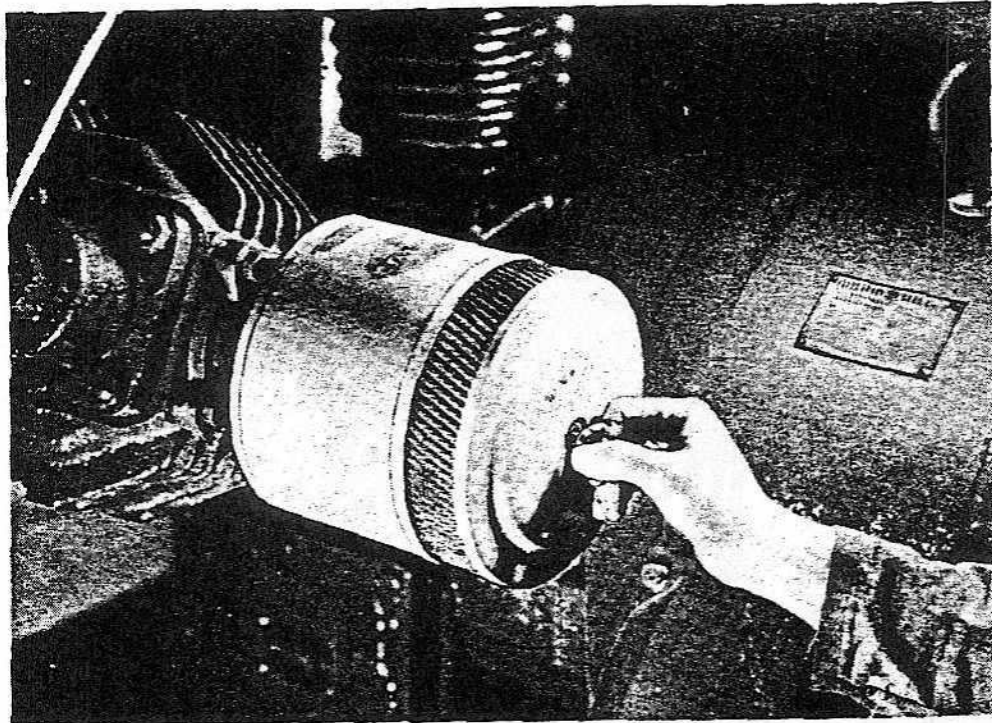

Figure 128—Making Pressure  
(Cut-off) Adjustment

**OPERATION**



RA PD 38816A

**Figure 129—Removing Wing Nut—Air Compressor**

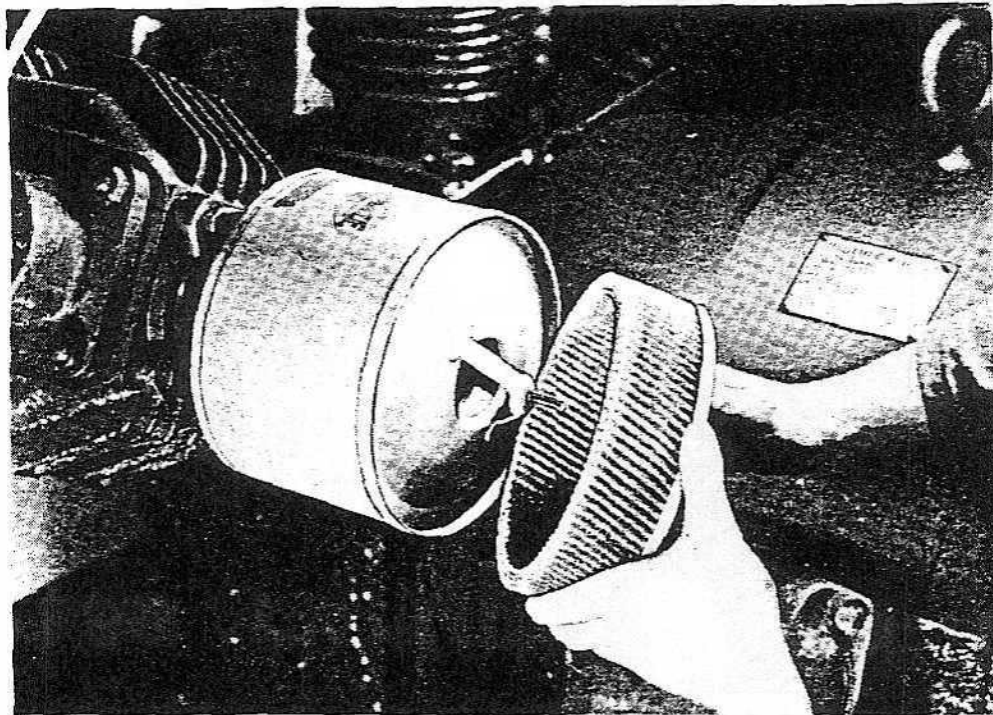

RA PD 38816

**Figure 129-1—Removing Air Filter Element for Cleaning—  
Air Compressor**

16-INCH SEACOAST GUN MATERIEL  
GUN MK. II M1; BARBETTE CARRIAGE M4

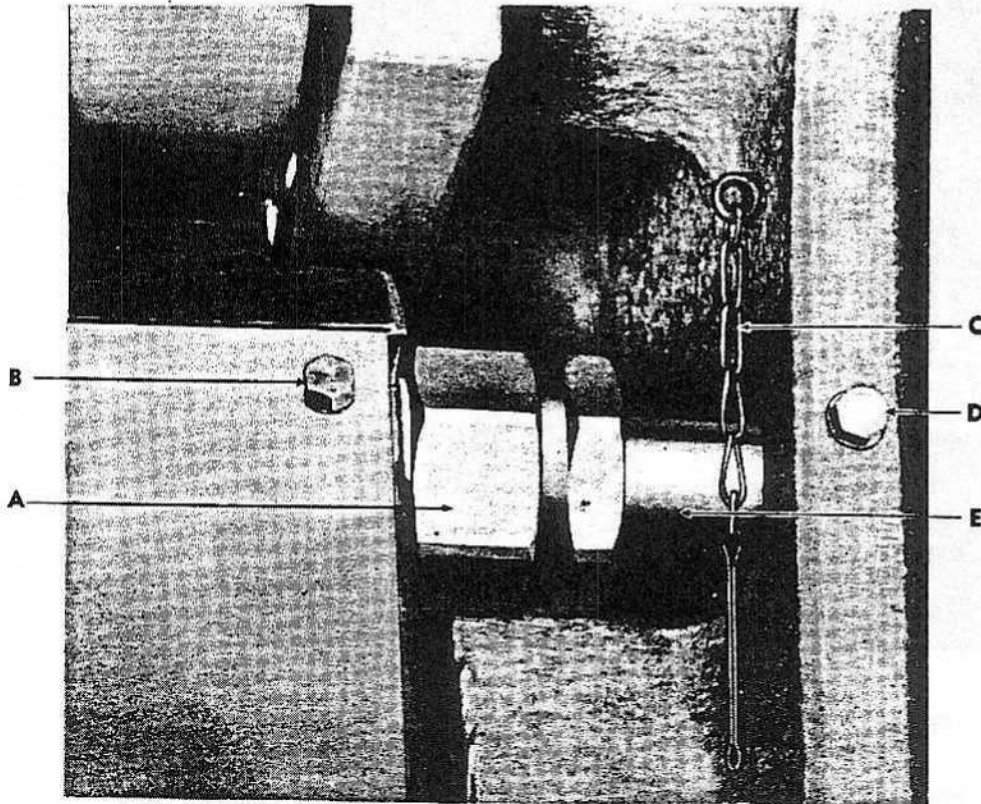

LOCKED POSITION

- A—NUT B7010
- B—SET SCREW A10029B AND LOCK WASHER BECX1M
- C—CRADLE LOCK CHAIN (ASSEMBLY) B187351

- D—SET SCREW A10029A AND LOCK WASHER BECX1M
- E—BOLT B7009
- F—STUD B7008

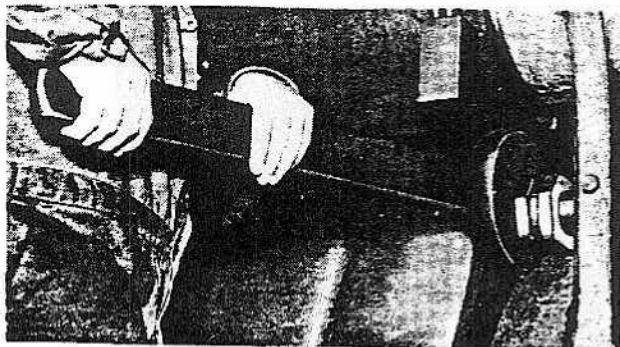

LOOSENING CRADLE AND RECOIL PARTS LOCK  
(TO TIGHTEN NUT—PULL UP ON WRENCH)

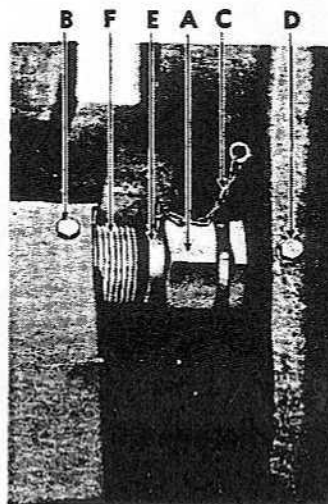

UNLOCKED POSITION

RA PD 38721

Figure 130—Cradle and Recoil Parts Lock

**OPERATION**

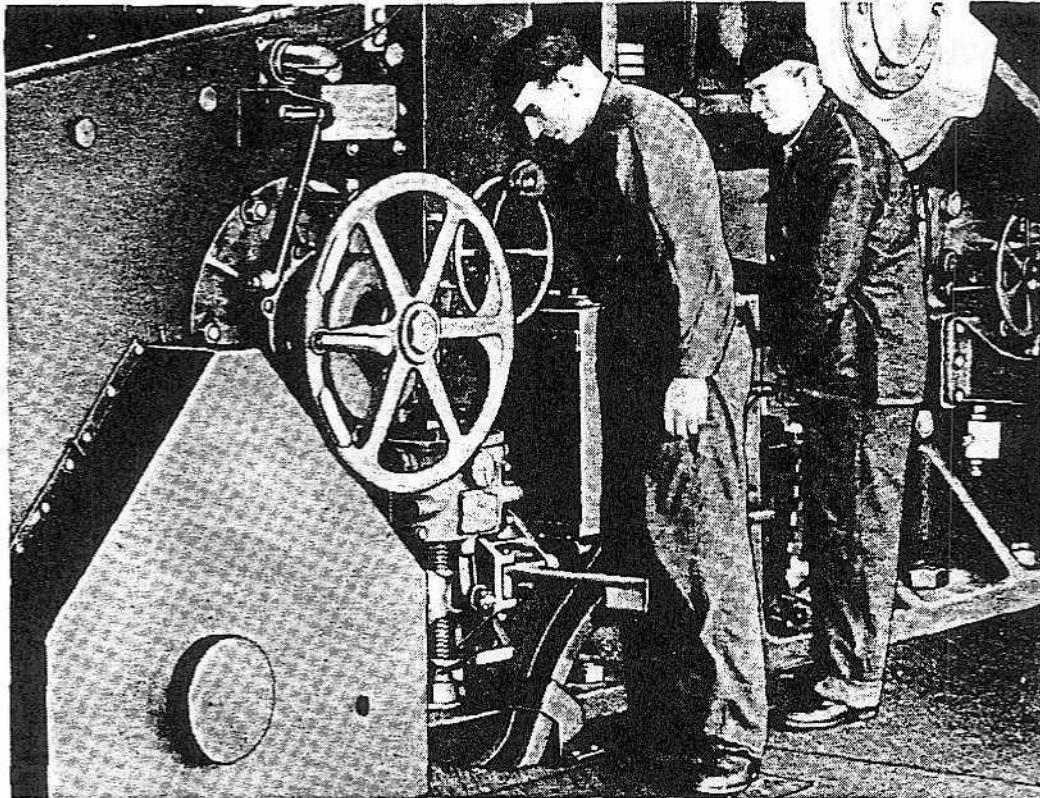

RA PD 38817A

**Figure 131—Operating Elevating Follow-up Control (Elevating Handwheel Power Clutch Shift Lever in "Power" Position)**

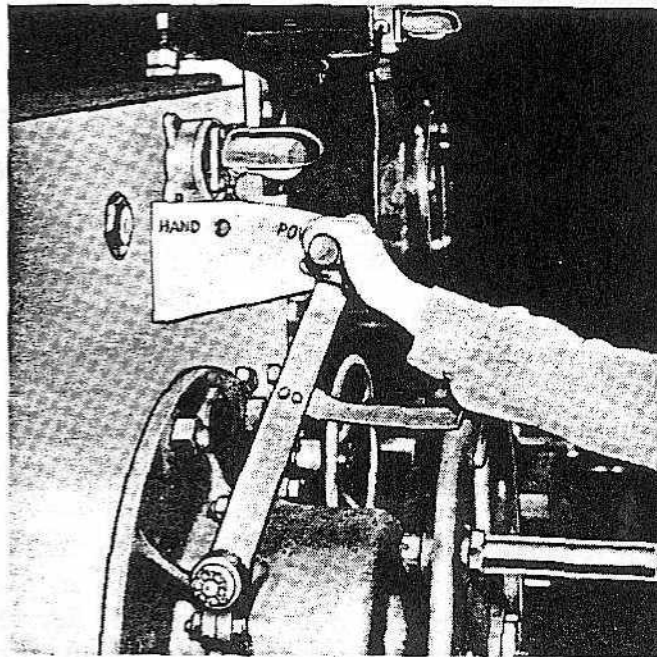

RA PD 38817

**Figure 131-1—Operating Elevating Handwheel Power Clutch Shift Lever**

**16-INCH SEACOAST GUN MATERIEL  
GUN MK. II M1; BARBETTE CARRIAGE M4**

OBSERVING CLEARANCE  
WHILE ADJUSTING  
BRAKE BAND  
SPRING SUPPORT

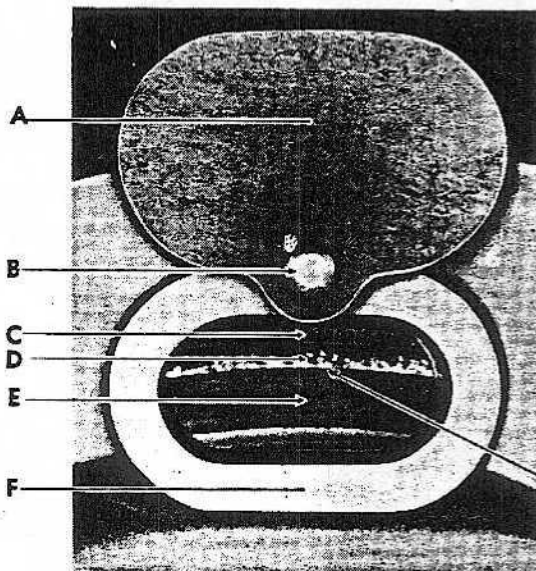
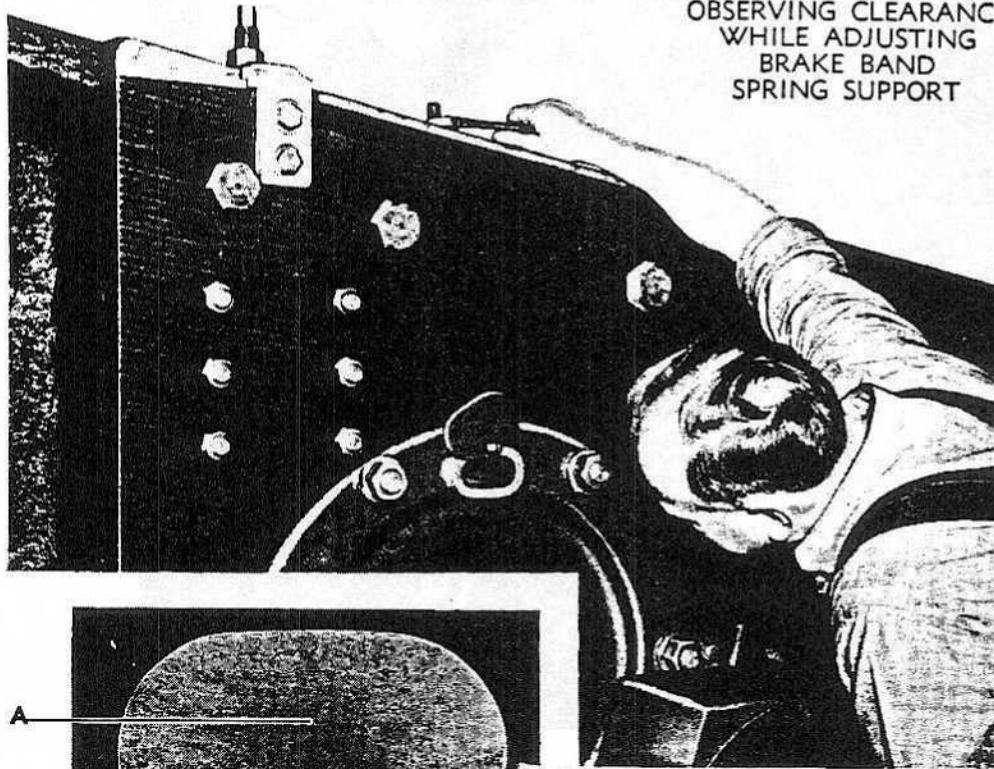

- A—BRAKE BAND PEEP HOLE COVER A149803
- B—RIVET BMCX1
- C—BRAKE BAND C54880
- D—BRAKE BAND LINING C54881
- E—BRAKE DRUM B162991
- F—(LEFT SIDE) DRUM SHAFT BEARING C54861 (RIGHT SIDE) GEAR CASE D42539

CLEARANCE OF 1/32 INCH  
WHEN BRAKE IS "OFF"

RA PD 38770

**Figure 132—Elevating Brake Band Clearance (Brake Levers Up)**

129. The air filter elements must be washed in light oil, *not* kerosene or gasoline.

**h. Elevating the Gun by Hand.** The gun should be elevated and depressed within prescribed limits periodically to insure proper operation of the parts.

(1) Before any action is taken to elevate the gun either by hand or power, the cradle and recoiling parts lock (fig. 130) *must* be in place with the nut (A, fig. 130) securely screwed onto the stud (F, fig. 130) to avoid any slipping of the gun through the cradle, which might occur if the air pressure in the recuperator cylinders should be less than that required to hold the gun in battery at various degrees of elevation.

(2) **ELEVATING CLUTCH SHIFTER LEVER.** To elevate the gun by

**OPERATION**

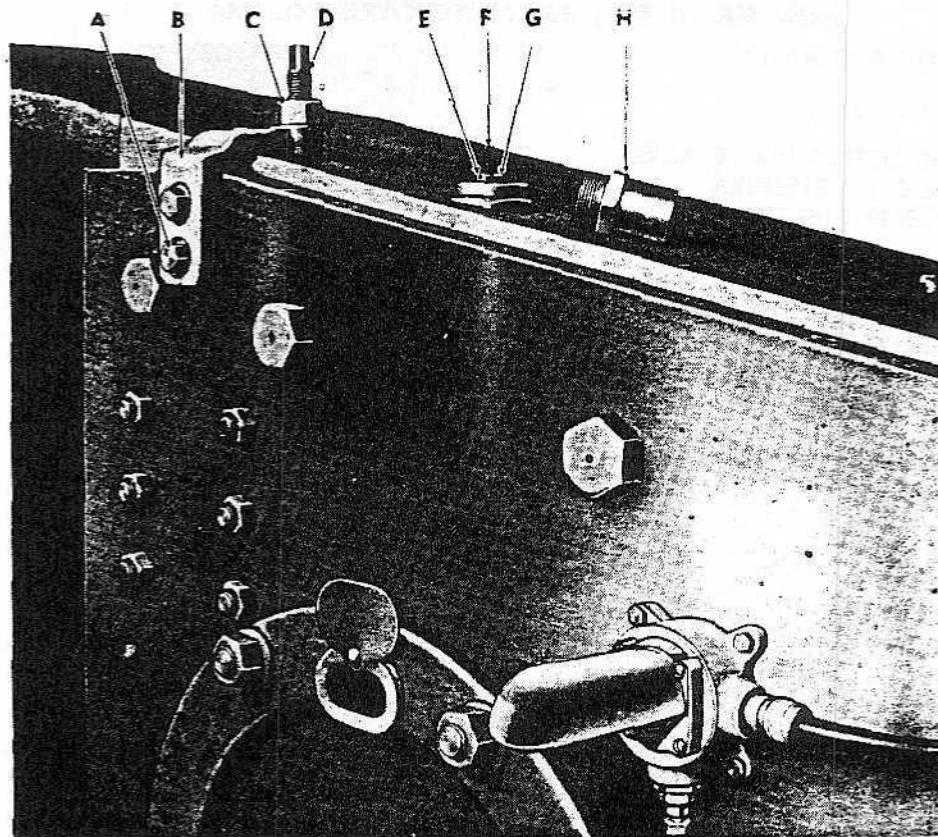

- |  |  |
|--|--|
| <p>A—(SPRING INDICATOR) SCREW<br/>BCAX2BD</p> <p>B—(BRAKE GRIPPING) SPRING<br/>INDICATOR A149870</p> <p>C—(BRAKE GRIPPING) SPRING<br/>ADJUSTING NUT B163029</p> <p>D—(BRAKE GRIPPING) SPRING ROD<br/>B163027</p> | <p>E—(BRAKE BAND SUPPORT<br/>ADJUSTING) NUT BBGX1E</p> <p>F—BRAKE BAND SUPPORT ROD<br/>(LONG) B163032</p> <p>G—SPLIT COTTER PIN (1/8 x 1/4)<br/>BFAX1DH</p> <p>H—(BRAKE BAND SUPPORT)<br/>RETAINER CAP A149874</p> |
|--|--|

RA PD 38769A

**Figure 133—Elevating Brake Band Spring Support and  
Gripping Spring Adjusters**

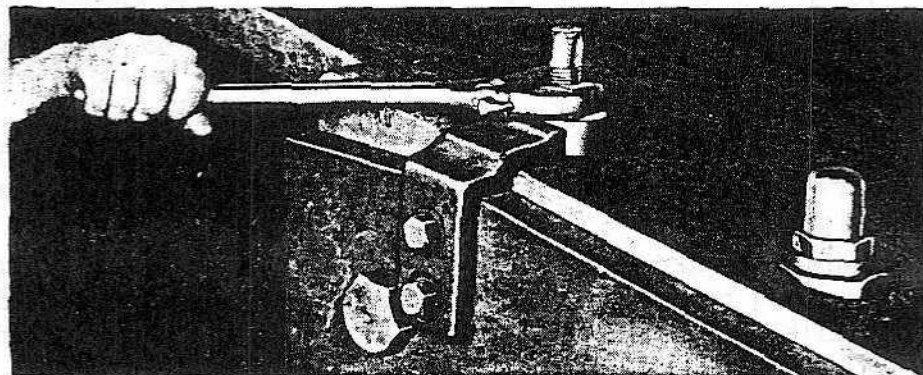

RA PD 38769

**Figure 133-1—Adjusting Tension of Brake Gripping Spring**

**16-INCH SEACOAST GUN MATERIEL  
GUN MK. II M1; BARBETTE CARRIAGE M4**

- A—SCREW BCAX2CM
- B—NUT BBAX2D
- C—ADJUSTING ROD BRACKET  
(RIGHT) B163028A  
(LEFT) B163028B
- D—WASHER BEBX1R
- E—(ADJUSTING ROD) NUT  
BBAX2C
- F—ADJUSTING ROD  
A149877
- G—SCREW BCAX2CE

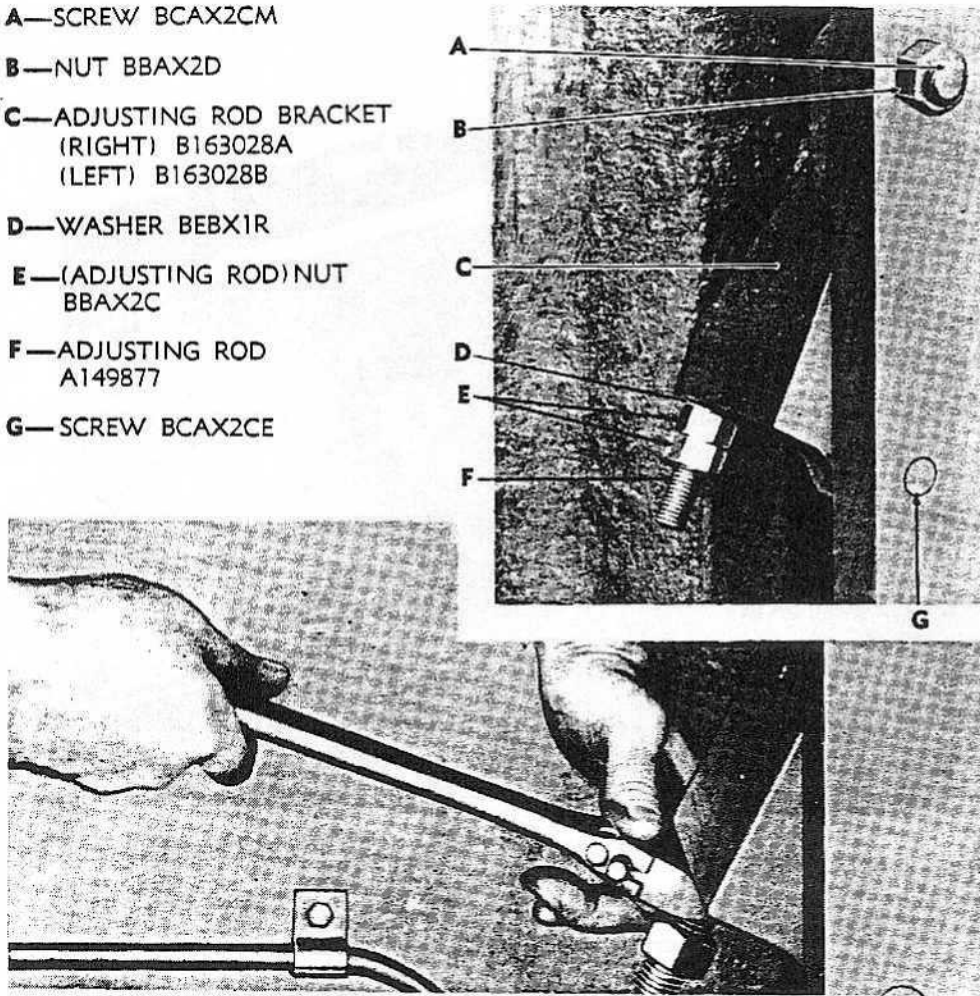

RA PD 38771

**Figure 134—Elevating Brake Wear Adjustment**

hand the elevating clutch shifter lever (F, fig. 74), located at the elevating handwheel, must be set at "HAND" position (fig. 131).

(3) **ELEVATING BRAKES.** The elevating brakes on this mount are habitually set, locking the tipping parts and preventing any elevating or depressing movement of the gun until friction on the brake drums (figs. 132 and 79) is released.

(4) **BRAKE LEVERS.** Brake release levers (Q and R, fig. 68), located on the right side of the carriage, are designed for locking the brakes at any desired position.

(a) Before any action is taken to elevate or depress the gun either by hand or motor power, the levers must be raised and held in raised position until the gun has been elevated or depressed to the desired angle.

(b) These levers are connected to a cross shaft (W, fig. 80) and provide braking action on both right and left brake drums. When released

OPERATION

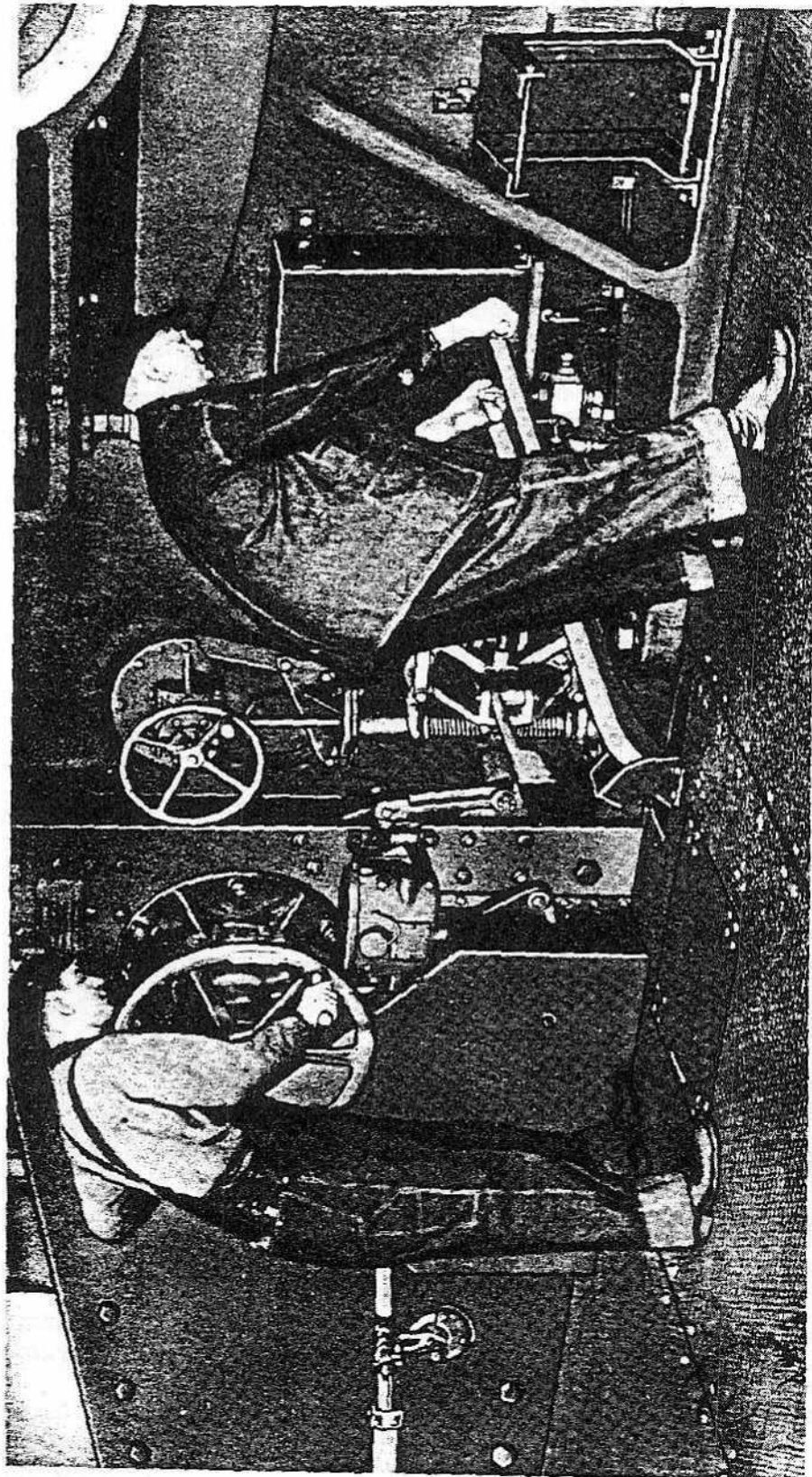

RA PD 38818

Figure 135—Operating Elevating Handwheel and Elevating Brake Release Levers



16-INCH SEACOAST GUN MATERIEL  
GUN MK. II, M1; BARBETTE CARRIAGE M4

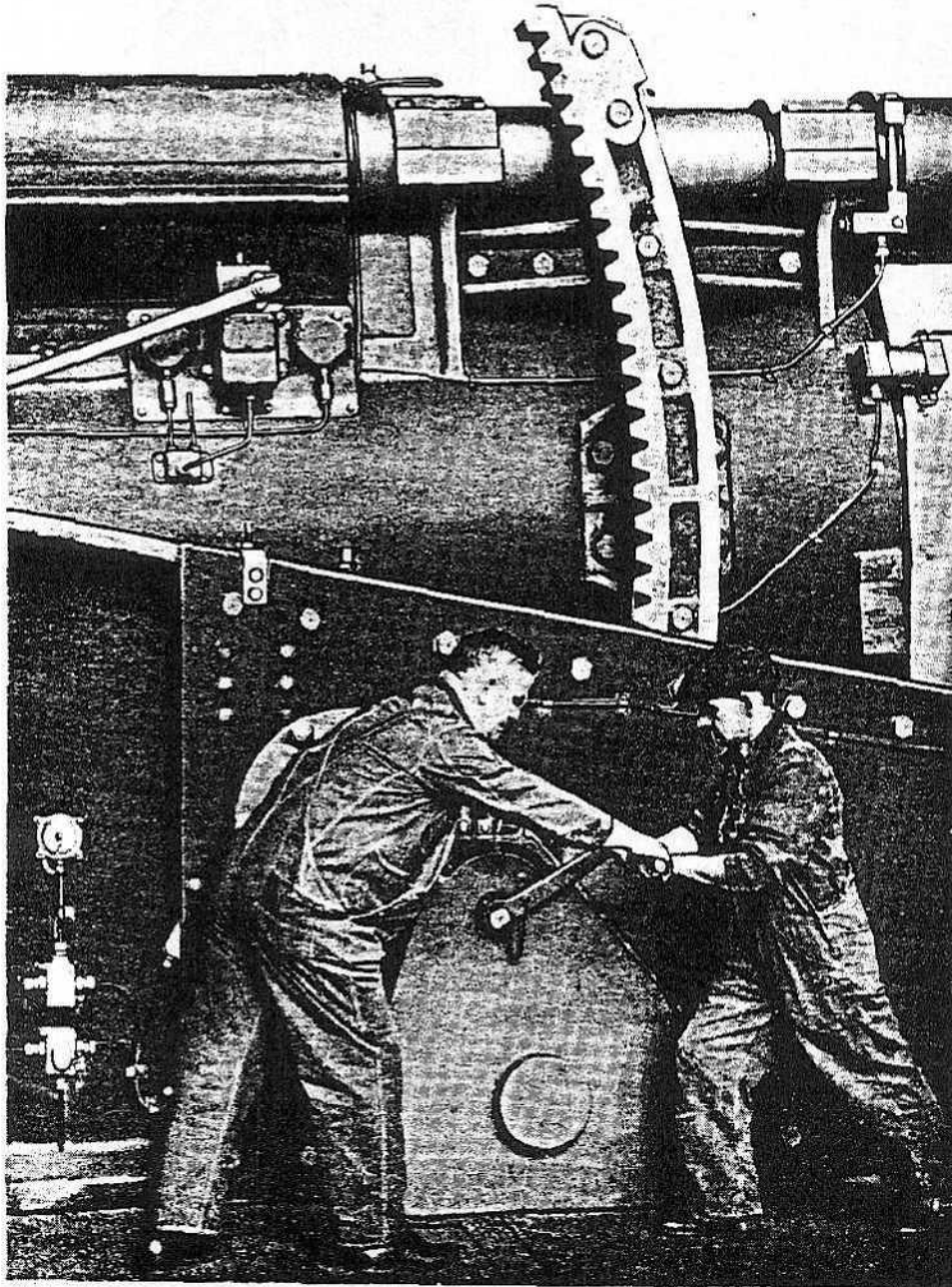

RA PD 38819

**Figure 136—Operating Elevating Crank**

the levers return by gravity to a horizontal position. This movement results in locking the brake band (fig. 132, and D, fig. 79) to the drums, thus preventing further movement of the tipping parts.

(c) Observation and test of the braking mechanism must be made at frequent intervals to insure that there is no binding or drag on the brake drums when the brake levers are raised, and that the brake drums and bands are properly in contact when the brake levers are released.

### OPERATION

(d) A peephole (fig. 132) is provided in the covers of the right and left brake drums which enables the operator to check the clearance between the drums and brake bands.

(e) Devices for adjusting the friction on the brake drums and for maintaining concentricity of the brake bands are located on the upper surfaces of the right and left side frames. When the brake levers are raised to maximum elevation a clearance of  $\frac{1}{32}$  inch should exist between the brake drums and bands; and frequent tests will be made to insure that this condition exists. Adjustment of clearance between the brake



RA PD 38820

**Figure 137—Testing Trunnion Clearance**

drums and bands will be made by removing the caps (H, fig. 133) from the adjusting screws and loosening or tightening the nuts (E, fig. 133) until the required clearance is obtained. Adjustment of spring rod nuts (C, fig. 83) will be made as required to insure a proper grip of the brake bands on the drums when the levers are released.

(f) Wear of the brake bands is compensated for by tightening the inner nuts (fig. 134, and J, fig. 86) on the brake band adjusting rods. The adjustment is locked by the outer nuts.

(5) **ELEVATING HANDWHEEL.** For hand elevation an elevating handwheel (E, fig. 74) and (fig. 135) is provided on the right side of the mount and an elevating crank (fig. 136) on the left side. Hand power for elevating may be applied on the handwheel and crank simultaneously. These units are directly connected and cannot be operated independently.

(6) **LOADING POSITION POINTER.** A loading position pointer (P, fig. 73), which enables the operator to quickly set the gun to the correct loading angle of 3 degrees, 48 minutes, is located on the right side frame

**16-INCH SEACOAST GUN MATERIEL  
GUN MK. II M1; BARBETTE CARRIAGE M4**

near the elevating and motor control handwheels. This device is located so as to make plainly visible to the operator on the right side of the carriage whether the gun is being elevated by hand or power. It is not to be considered as a means of setting the gun for any purpose other than loading.

(7) CRADLE TRUNNION CLEARANCES.

(a) Before either hand or power elevation is undertaken the position of the cradle trunnions in relation to the trunnion beds in the side

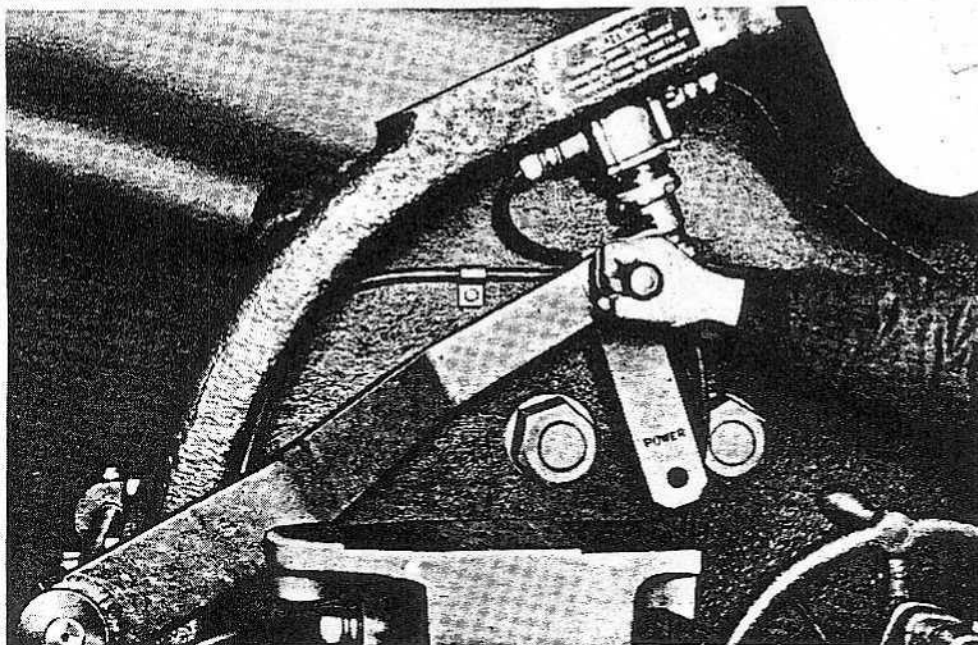

RA PD 38822

**Figure 138—Operating Traversing Clutch Shift Lever (in Position for Manual Traversing) —Sight and Sight Bracket not Assembled**

frames must show a clearance at the bottom of the trunnion of exactly 0.008 of an inch, this measurement to be taken at the inside of the right and left side frames (fig. 137). Should the clearance at this point be greater or less than 0.008 of an inch, adjustment must be made by means of the lower adjusting nuts (C, fig. 76, and H, fig. 77) located under the rear ends of the antifriction levers (P, fig. 76, and D, fig. 77) until the prescribed clearance is obtained.

(b) To increase the clearance between the trunnion and trunnion bed, release the locking nut (B, fig. 76, and J, fig. 77) on the lower end of the Belleville spring rod (A, fig. 76, and K, fig. 77), and turn the adjusting nut (C, fig. 76, and H, fig. 77) until proper clearance between the trunnions and trunnion beds is obtained. Then reset the lock nut. The using service will not attempt to make adjustments of the tension on the Belleville springs (D, fig. 76, and G, fig. 77).

(c) For clearance test use thickness gage furnished with the armament chest.

OPERATION

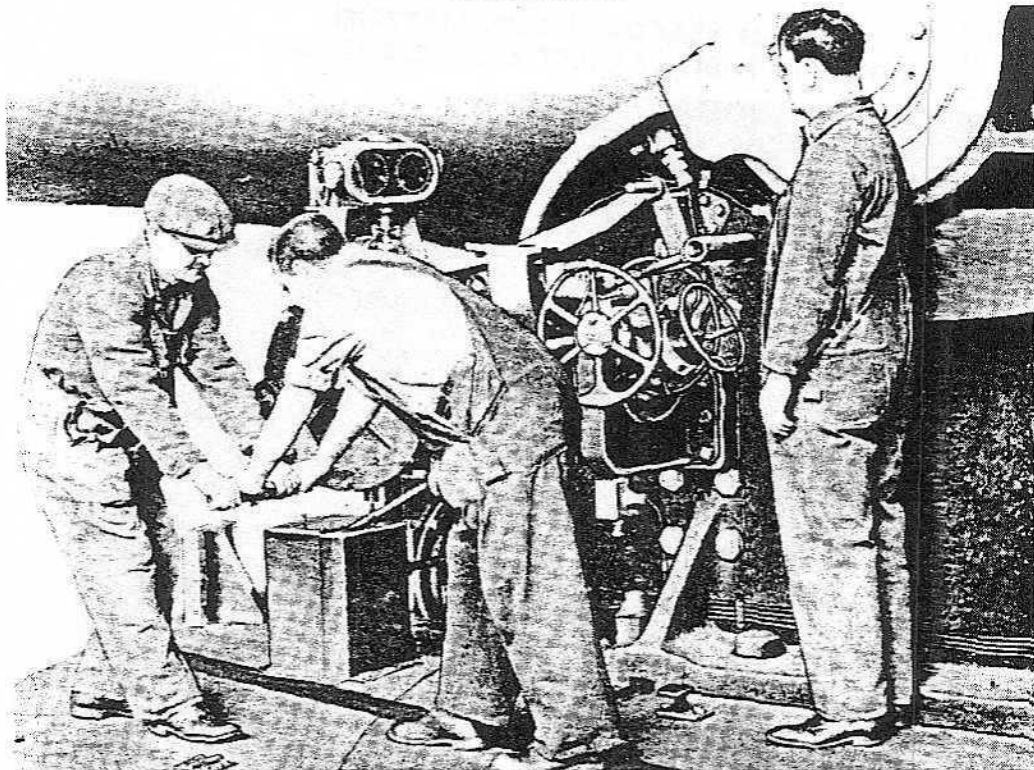

RA PD 38823

Figure 139—Operating Left Traversing Crank (Shown without Shield)

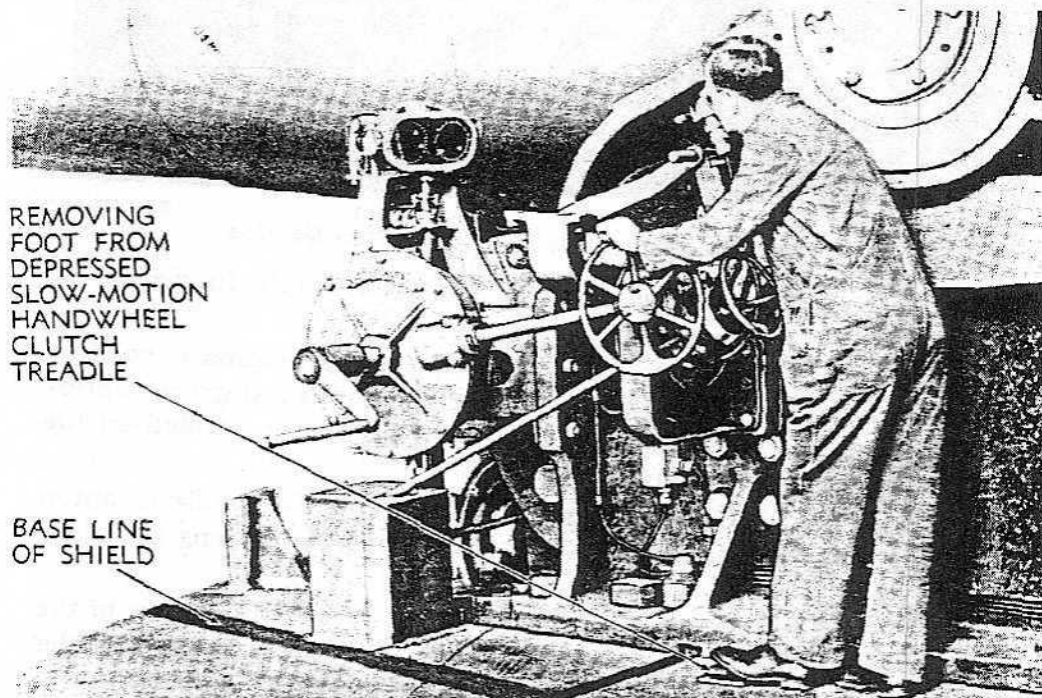

RA PD 38824

Figure 140—Operating Left Traversing Handwheels

16-INCH SEACOAST GUN MATERIEL  
GUN MK. II M1; BARBETTE CARRIAGE M4



**Figure 141—Adjusting Multi-disk Friction Device**

RA PD 38825

(d) The trunnion bearings must be kept thoroughly lubricated at all times (see section IV, paragraph 18).

(8) **ELEVATION POINTER.** To determine the approximate position of the gun at various degrees of elevation from minus 3 degrees depression to 46 degrees elevation, graduation lines have been scribed on the surface of the right trunnion bearing (fig. 76).

(a) An elevation pointer (J, fig. 76) attached to the cradle trunnion registers the approximate angle of elevation when the tipping parts are maneuvered.

(b) Final determination of the angle of fire is made by means of the dial readings on the elevation data receiver; but the gun commander should observe the elevation pointer on the trunnion to set the gun to approximate firing position.

**i. Elevating the Gun by Power.**

(1) To elevate the gun by power set the elevating clutch shifter lever (F, fig. 74) at "POWER" position (fig. 131).

## OPERATION

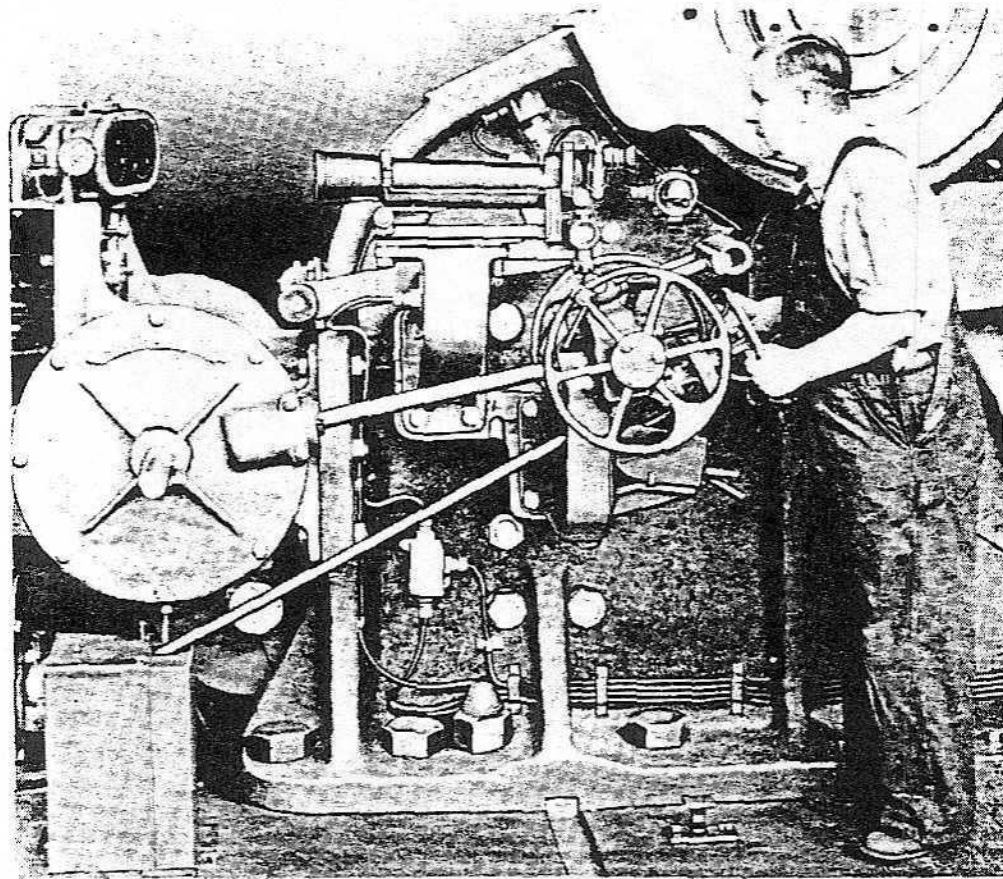

RA PD 38826

**Figure 142—Operating Traversing Speed-gear Control (Upper)  
(Clutch Shift Lever in "Power" Position)**

(2) Press the "START" button at the elevating push-button station (Q, fig. 151) to activate the elevating motor (W, fig. 151) which is located in the elevating motor chamber under the right platform.

(3) Turning the handwheel clockwise depresses the gun; turning the wheel counterclockwise elevates it.

(4) Elevating and depressing speeds are controlled by the operation of the follow-up control handwheel which regulates the movement of the gun through operation of the motor speed gear. When the follow-up control handwheel is not being turned, the gun will be held motionless in its trunnions by the elevating hydraulic speed gear. When operating by power, the hand elevating crank (fig. 136) on the left side of the mount should be removed.

(5) FOLLOW-UP CONTROL. To elevate or depress the gun as required, manipulate the follow-up control handwheel (J, fig. 68, and L, fig. 69), following the direction indicated by the direction marks on the control handwheel.

16-INCH SEACOAST GUN MATERIEL  
GUN MK. II M1; BARBETTE CARRIAGE M4

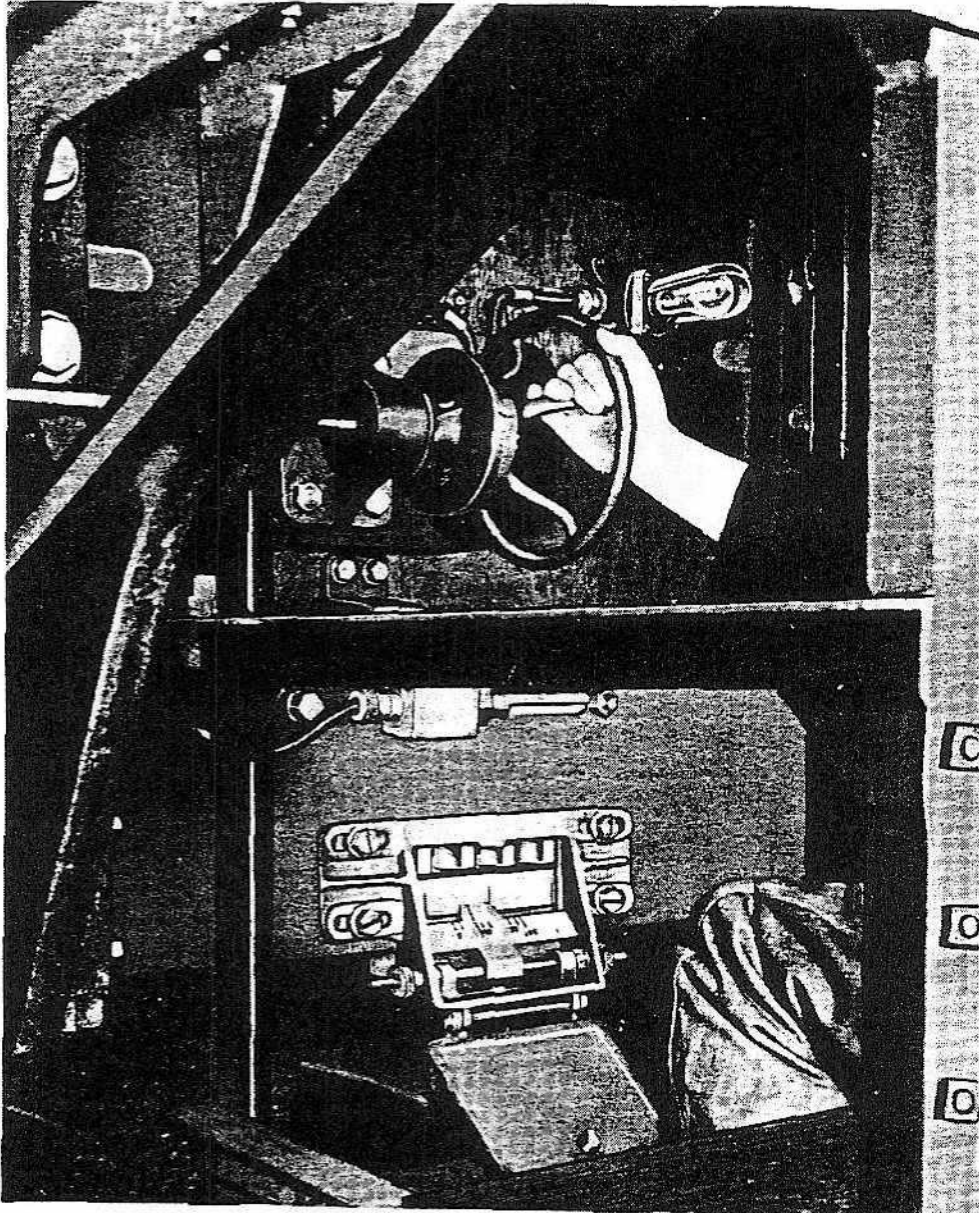

RA PD 38827

**Figure 143—Operating Azimuth Observer's Speed-gear Control**

(a) Turning the control handwheel counterclockwise elevates the gun; turning the handwheel clockwise depresses the gun.

(b) The follow-up control mechanism enables the operator to control the elevation and depression of the gun by power and also to stop the movement of the gun at any desired position. This is accomplished by means of the control handwheel (J, fig. 68, and H, fig. 71).

(c) Turning the control handwheel in the direction indicated by the arrows on the handwheel causes the control shaft to rotate and start the speed gear in motion thus operating the elevating gearing. The construction of the gearing is such that movement of the piece in elevation ceases

SPARE PARTS AND ACCESSORIES

RA PD 35707

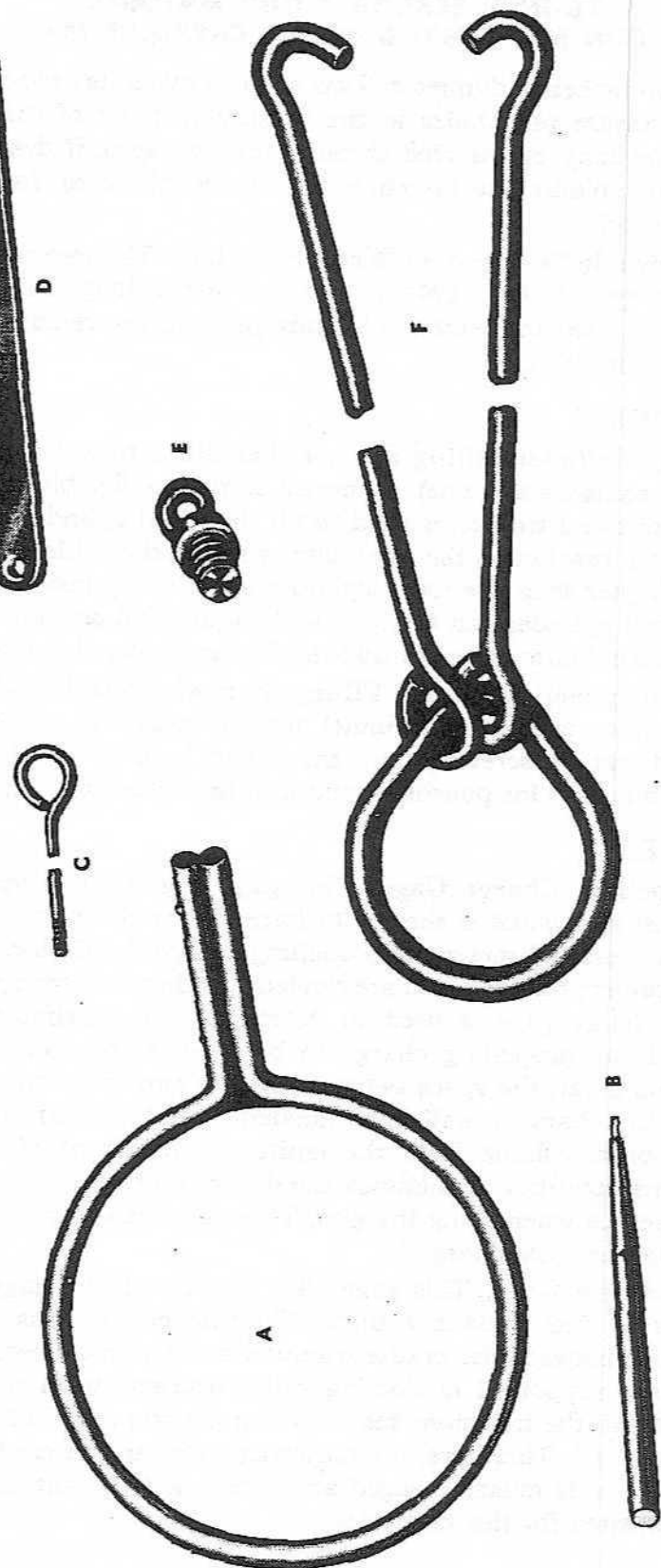

- A — PROPELLING CHARGE GAGE
- B — TORSION WASHER ASSEMBLY PIN
- C — REDUCING VALVE LIFTING BOLT
- D — THICKNESS GAGE
- E — OBTURATOR SPINDLE EYE BOLT
- F — ROLLER LIFE HOOK

Figure 191—Tools



**16-INCH SEACOAST GUN MATERIEL  
GUN MK. II M1; BARBETTE CARRIAGE M4**

or an eye two inches in diameter. Two of these eyebolts are screwed into the blank pressure plug holes in the mushroom head of the obturator spindle. A rod may be inserted through the two eyes, if desired, to lift the obturator spindle for insertion into breechblock or for removing from breechblock.

b. **Removable Primer Seat Wrench Eyebolt.** The removable primer seat wrench eyebolt (fig. 194) is about 3 inches long and  $\frac{1}{4}$  inch in diameter. It is used to insert the locking piece in the removable primer seat wrench (fig. 194).

**71. FUNNELS.**

a. **Recoil Cylinder Filling Funnel.** The filling funnel assembly (fig. 190) which contains a funnel, a bronze ferrule, a flexible copper tube, a nipple, a nut and washer, is used to fill the recoil cylinder. The funnel is hooked on a bracket on the right side of the cradle. This bracket keeps the funnel higher than the recoil cylinder and the expansion chamber so that the recoil cylinder can be filled with liquid and any air that might remain in the cylinder is forced up into the expansion chamber.

b. **Counterrecoil Cylinder Filling Funnel.** This funnel assembly (fig. 190), which consists of a funnel, ferrule, coupling, a short nipple, a washer and nut, is screwed over the filling hole of the counterrecoil cylinder and is used for pouring liquid into the cylinder.

**72. GAGES.**

a. **Propelling Charge Gage.** This gage (fig. 191) is made from a  $\frac{1}{2}$ -inch brass rod which is shaped to form a true circle, the diameter of which is the exact diameter the propelling charge should have. The ends of the rod project outward and are riveted together to form a handle. The propelling charge gage is used to determine the maximum allowable diameter of the propelling charge to be used. If the diameter of the charge is too great, the space between the top surface of the charge and the top of the chamber wall is eliminated, thereby interfering with the projection of the flame from the igniter to the front of the powder charge. This condition sometimes builds up excessive pressures which prove dangerous when firing the gun. This gage, however, is not used on the "core-igniter type charge."

b. **Thickness Gage.** This gage (fig. 191) is a feeler gage which is a strip of spring steel 0.008 inch thick. The thickness gage is used to gage the clearance between the cradle trunnion and trunnion bed. The cradle trunnions are supported in floating roller bearings until the gun is recoiled. In recoil the trunnions seat down in the trunnion bed to take care of the extra load. Therefore, the clearance between the cradle trunnions and trunnion beds must be gaged accurately and the antifriction device must be adjusted for this clearance.

**73. HAND RAMMER.**

a. The assembled rammer (fig. 192) and staff is commonly called

SPARE PARTS AND ACCESSORIES

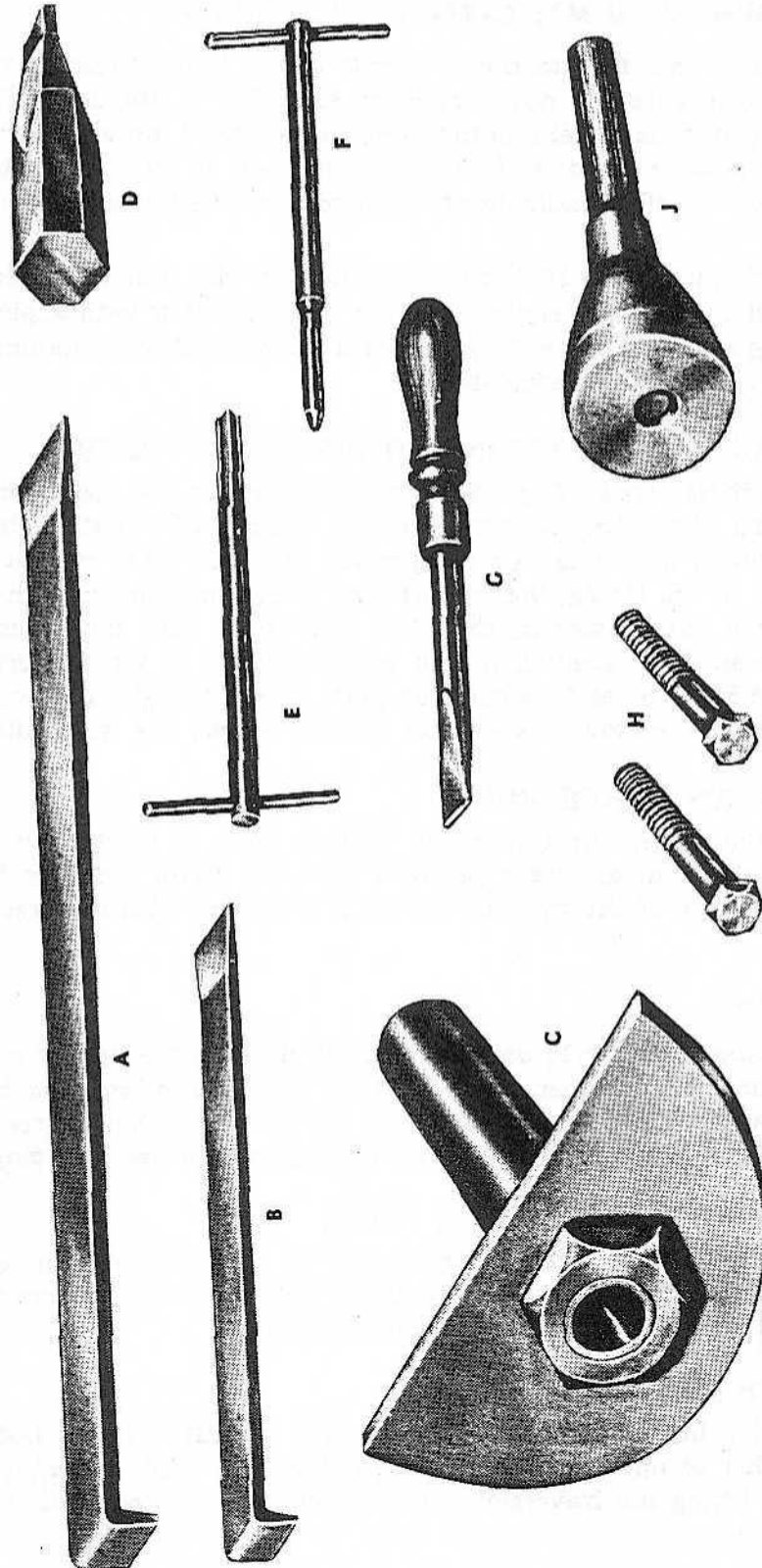

- A — METAL SCRAPER (FOR CARRIAGE)
- B — METAL SCRAPER (FOR GUN)
- C — STEEL SCRAPER & SOCKET
- D — SPRING ROD PISTON SCREWDRIVER
- E — PRIMER SEAT REAMER
- F — PRIMER SEAT SLOPE REAMER
- G — CAM ROLLER PIVOT SCREWDRIVER
- H — LOADING THROUGH SPRING COMPRESSING SCREWS
- J — HAND RAMMER

RA PD 35706

Figure 192 — Tools

**16-INCH SEACOAST GUN MATERIEL  
GUN MK. II M1; BARBETTE CARRIAGE M4**

the rammer. It is used to ram the projectile firmly into its seat in the bore of the gun in case the power rammer assembly is not used. The hand rammer proper is an aluminum cone-shaped head provided with a coupling for fastening the staff. A scale (fig. 188) is marked on the cylindrical wooden staff to indicate when the projectile is properly seated in the bore.

b. If a staff longer than 20 feet is desired, splice the staff with other staff sections of the desired length, coupling them together with a piece of boiler tubing about 10 inches long and with the same outside diameter as that of the cylindrical wooden staff.

**74. LOADING TROUGH SPRING COMPRESSING SCREWS.**

a. Two of these screws (fig. 192) are provided for the assembling or disassembling of the loading trough spring balance unit plate. When the loading trough spring is not compressed and the plate is placed against the end of the spring, the compressing screws are long enough to run through the outer holes in the plate and screw into the trough, thereby compressing the loading trough springs enough to screw shorter screws into the inner holes to secure the plate to the trough. The compressing screws are removed when the shorter screws are assembled.

**75. PLUMBER'S FORCE PUMP.**

a. This hand pump, in connection with a hose, is used to flush SOLVENT, dry-cleaning, under pressure into the recoil cylinder for cleaning the interior of the cylinder before it is refilled with new recoil fluid.

**76. REAMERS.**

a. Two reamers (fig. 192) are provided for cleaning the primer seat. One is the primer seat reamer which is about nine inches long and has a T-shaped handle. The other is similar to the above but has a greater slope on the cutting end and it is used for cleaning the primer seat slope.

**77. REDUCING VALVE LIFTING BOLT.**

a. This bolt (fig. 191) is about six inches long with an eye at one end and threads at the other. It is used for lifting the breech mechanism reducing valve piston from the reducing valve dash pot.

**78. ROLLER LIFT HOOK.**

a. The roller lift hook assembly (fig. 191) consists of two hooks fastened together at one end by a common ring. The hook assembly is used to aid in lifting the traversing rollers when they are removed from the racer.

**79. SCRAPERS.**

a. Metal Scrapers. There are two metal scrapers (fig. 192) both pro-

SPARE PARTS AND ACCESSORIES

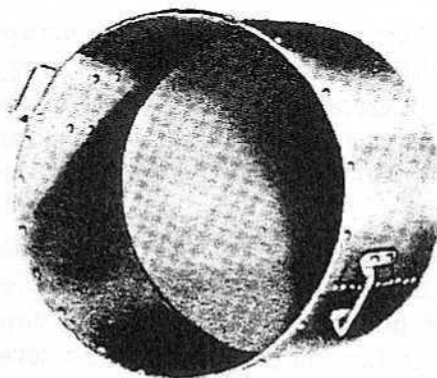

SPONGE TUB

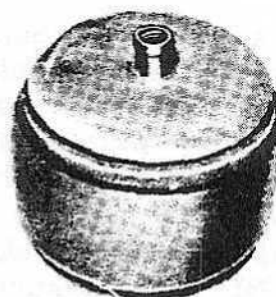

CHAMBER SPONGE

RA PD 33360

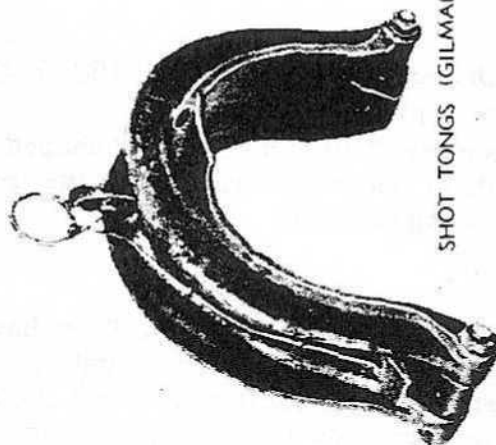

SHOT TONGS (GILMARTINI)

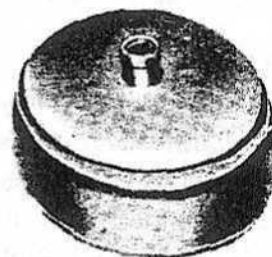

BORE SPONGE

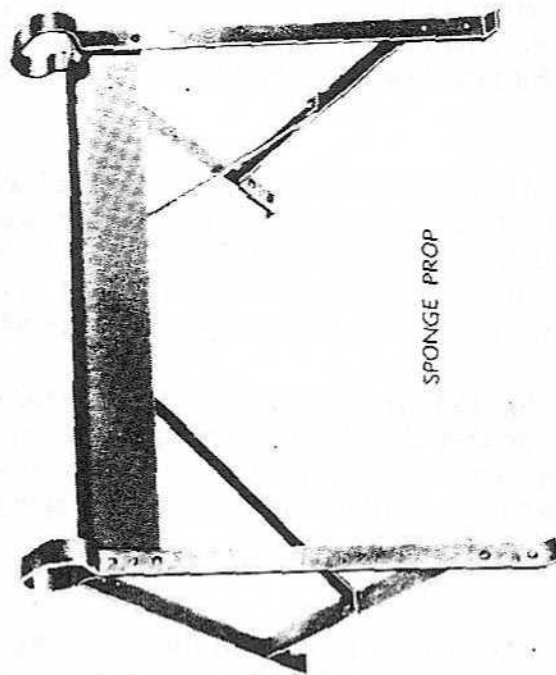

SPONGE PROP



SLUSH BRUSH

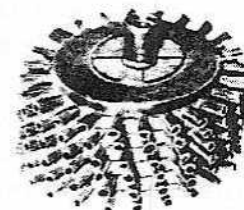

WIRE CLEANING BRUSH

Figure 193—Bore Cleaning Equipment and Shot Tongs

**16-INCH SEACOAST GUN MATERIEL  
GUN MK. II M1; BARBETTE CARRIAGE M4**

vided with a blade at each end. One (14 inches long) is used for scraping old paint and oil from gun surface, while the other (24 inches long) is used for scraping old paint and oil from carriage surfaces. These scrapers are used after a paint removing solution has been applied and begins to dry on the surface. The surface cleaning is completed by the use of mop and water.

b. **Steel Scraper and Socket.** This scraper (fig. 192) is used to scrape COMPOUND, rust preventive, from the bore of the gun, prior to cleaning and slushing operations. It should not be used for scraping copper deposits from the bore. Decoppering the bore is prohibited. The scraper consists of a semicircular steel blade which is secured to one end of a socket with a bronze nut. The sponge staff is screwed into the other end of the socket when required.

**80. SCREWDRIVERS.**

a. **Cam Roller Pivot Screwdriver.** This screwdriver (fig. 192) is used on the counterbalance cam roller pivot.

b. **Spring Rod Piston Screwdriver.** This is a hexagonal shaped bar screwdriver (fig. 192) with a blade at one end. It is used on the spring rod piston of the counterbalance closing cylinder.

**81. SHOT TONGS.**

a. The shot tongs (fig. 193) are the Gilmartin type. They have a steel cast frame which is semicircular in shape and fits snugly around the projectile near its center of gravity. Two cams which hold the projectile in the tongs are fitted to the two ends of the frame. A wire rope runs from each cam to a common ring at the top of the frame. When the ring is pulled the cams rotate. This action releases the projectile from the tongs. The tongs are used for handling projectiles in the emplacement.

**82. SPONGES.**

a. The *bore sponge* (fig. 193) is an aluminum casting around which is wrapped three strips of felt. Two thicknesses of burlap which are not shown in figure 193 are used to cover the core and the felt. A shank socket is provided on one end of the sponge into which the staff may be screwed when desired. This sponge is used for sponging the bore with a sponging solution.

b. The *chamber sponge* (fig. 193) is made up the same as the bore sponge described above, except that the chamber sponge has a greater diameter than the bore sponge and is used for sponging the chamber of the gun with the sponging solution. Burlap covering for this sponge is not shown in figure 193.

**83. SPONGE PROP.**

a. The sponge prop (fig. 193) is used as a stand for the sponge and staff. The head end of the sponge and staff rests upon the support in

**SPARE PARTS AND ACCESSORIES**

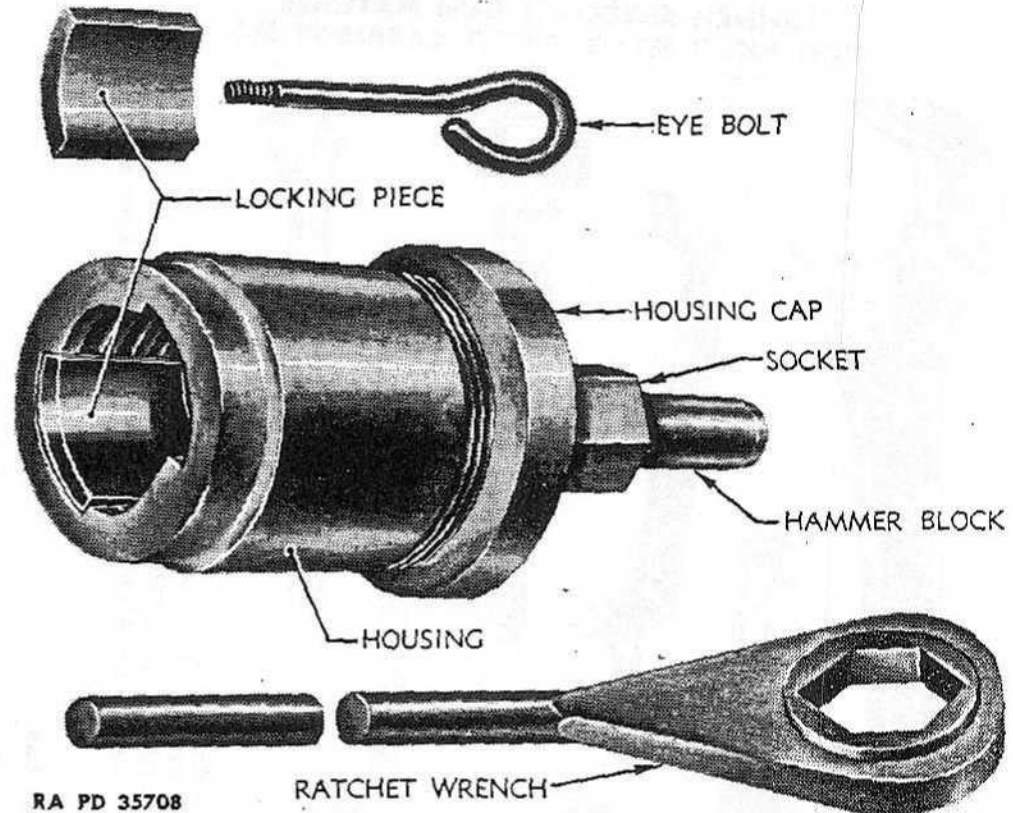

**Figure 194—Removable Primer Seat Wrench**

order to facilitate changing of head parts, also to insure that head parts are kept clean by being held above the ground.

**84. SPONGE TUB.**

a. The sponge tub (fig. 193) is used to rejuvenate the sponges. The tub is filled with a solution of water and castile soap in which the sponges are allowed to soak before sponging the bore or chamber.

**85. STAVES.**

a. **General.** The bore and chamber sponge staves are made up of cylindrical wooden sections two inches in diameter.

b. The *bore sponge staff* is composed of one section "B" (175 inches long), one section "E" (145 inches long), and five sections "E" (each 114 inches long). The total length of staff is 890 inches.

c. The *chamber sponge staff* is composed of one staff section "B" (175 inches long) and one staff section "E" (145 inches long) which makes the total length 320 inches.

**86. TORSION WASHER ASSEMBLY PIN.**

a. This is a steel tapered pin (fig. 191)  $4\frac{1}{2}$  inches long, used for assembling the torsion washer assembly in the firing lock. The pin is inserted in a hole in the torsion washer to aline a hole in the washer

16-INCH SEACOAST GUN MATERIEL  
GUN MK. II M1; BARBETTE CARRIAGE M4

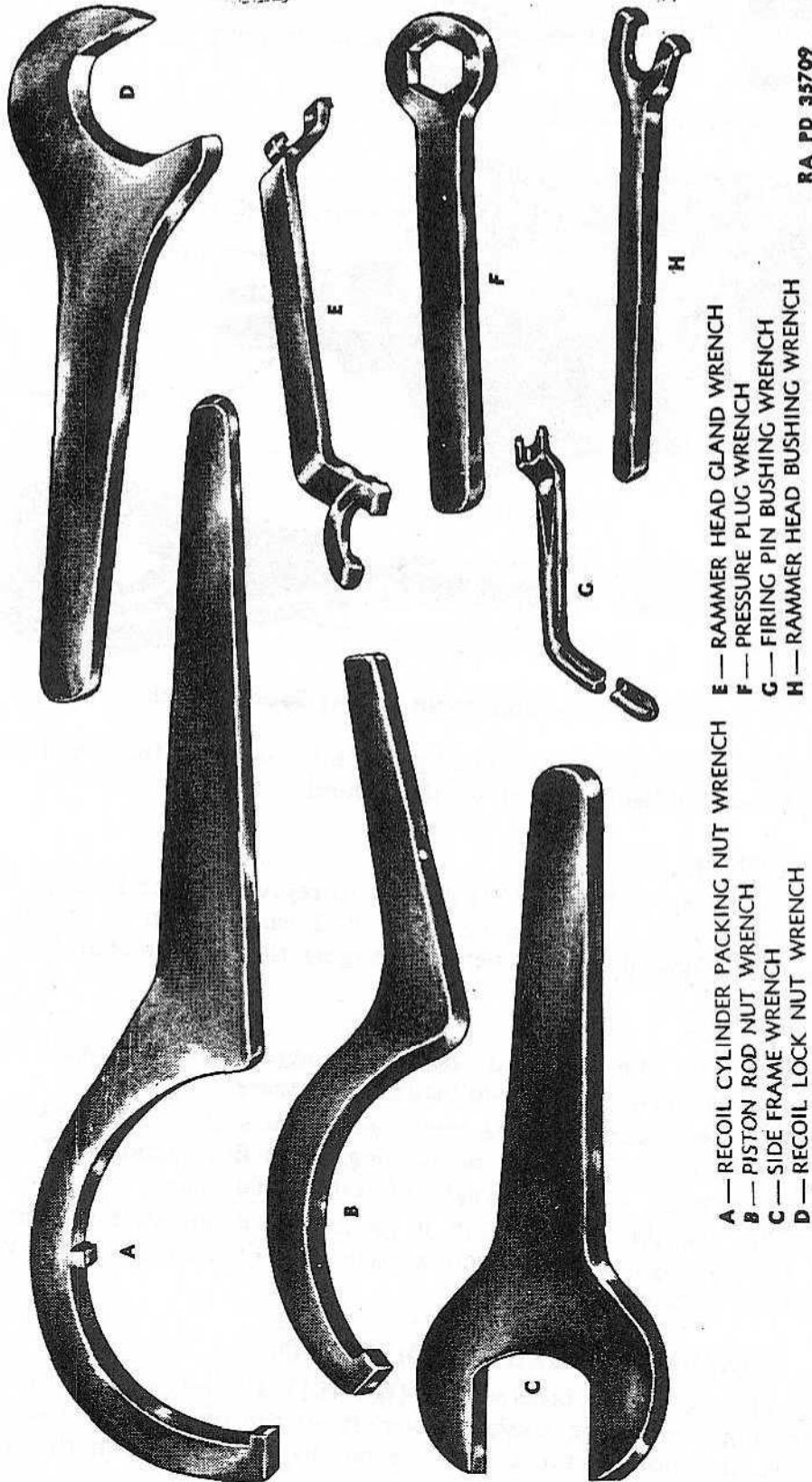

RA PD 35709

- A — RECOIL CYLINDER PACKING NUT WRENCH
- B — PISTON ROD NUT WRENCH
- C — SIDE FRAME WRENCH
- D — RECOIL LOCK NUT WRENCH
- E — RAMMER HEAD GLAND WRENCH
- F — PRESSURE PLUG WRENCH
- G — FIRING PIN BUSHING WRENCH
- H — RAMMER HEAD BUSHING WRENCH

Figure 195 — Wrenches

SPARE PARTS AND ACCESSORIES

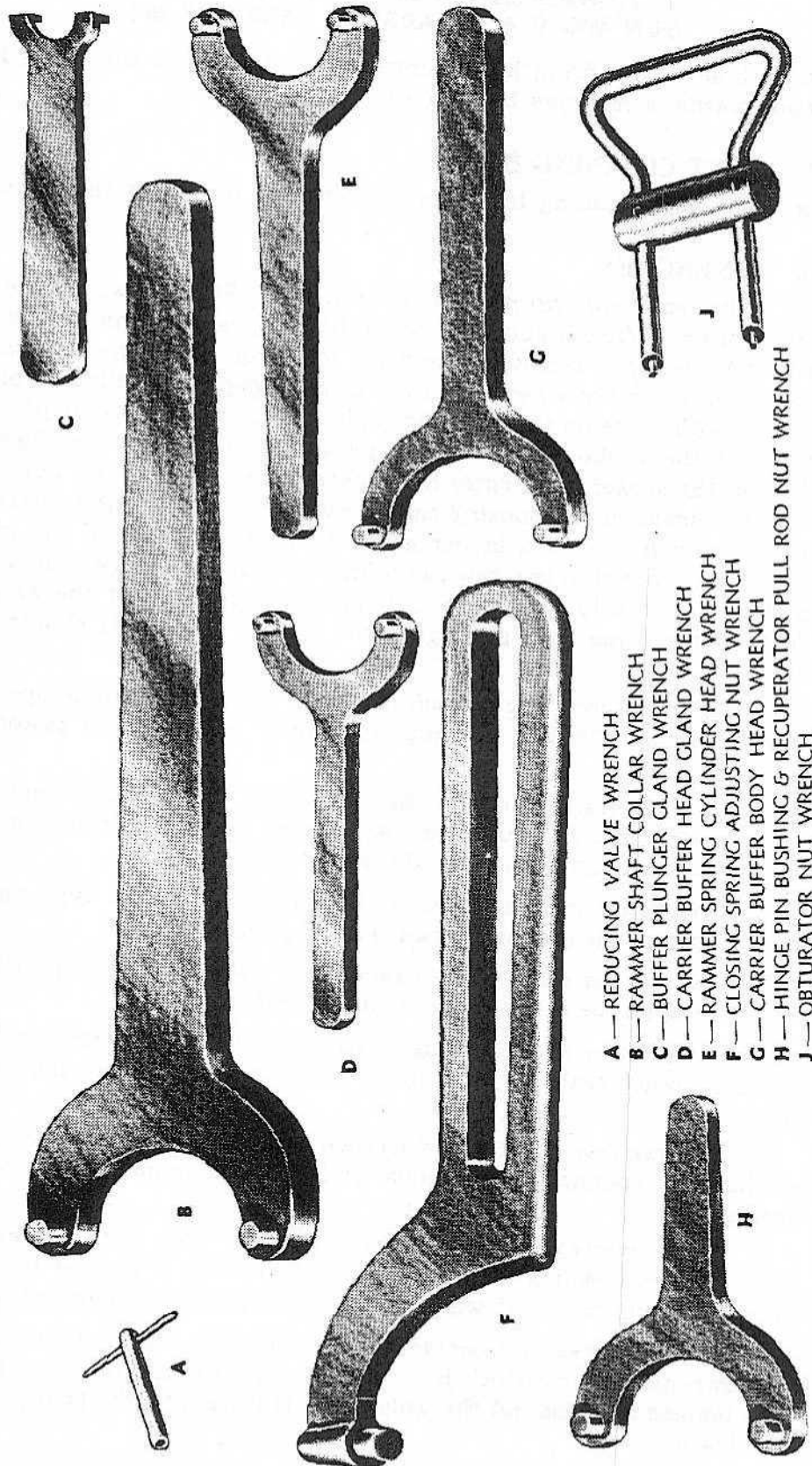

- A—REDUCING VALVE WRENCH
- B—RAMMER SHAFT COLLAR WRENCH
- C—BUFFER PLUNGER GLAND WRENCH
- D—CARRIER BUFFER HEAD GLAND WRENCH
- E—RAMMER SPRING CYLINDER HEAD WRENCH
- F—CLOSING SPRING ADJUSTING NUT WRENCH
- G—CARRIER BUFFER BODY HEAD WRENCH
- H—HINGE PIN BUSHING & RECUPERATOR PULL ROD NUT WRENCH
- J—OBTURATOR NUT WRENCH

RA PD 33415

Figure 196—Wrenches



**16-INCH SEACOAST GUN MATERIEL  
GUN MK. II M1; BARBETTE CARRIAGE M4**

with a hole in the firing lock hammer bracket so that the firing lock torsion washer screw may be inserted.

**87. VENT CLEANING BIT.**

- a. The vent cleaning bit is for cleaning the obturator spindle vent.

**88. WRENCHES.**

- a. The *removable primer seat wrench* (fig. 194) consists of the following pieces: Wrench housing, socket, housing cap, hammer block and locking piece. After removing the firing lock from obturator spindle install in its place the *wrench housing* after engaging the threads of the housing with those on the obturator spindle. Insert the *locking piece* by means of the eyebolt described in paragraph 70 b. Set the *hammer block* in the *socket*, then enter the *socket* in the *housing* and hold it in place by means of the *housing cap* screwed onto the *housing*. Place the *ratchet wrench* described in paragraph 88 l on the hexagon end of the *socket* and proceed to unscrew the primer seat. If the primer seat is hard to start, tap lightly with a hand hammer on the end of the *hammer block*, at the same time pulling on the ratchet wrench. It should then unscrew easily.

- b. The *recoil lock nut wrench* (fig. 195) is a special single open-end wrench with a 4.28-inch opening. It is used on the recoil piston rod lock nut.

- c. The *side frame wrench* (fig. 195) is a single-end wrench with 4.65-inch opening. It is used on the nuts of the taper dowels on each side at the front and at the rear of the side frame.

- d. The *piston rod nut wrench* (fig. 195) is a hook type spanner wrench used on the rear and forward recoil piston rod nuts.

- e. The *rammer shaft collar wrench* (fig. 196) is a face type spanner wrench used on the collar of the rammer shaft.

- f. The *rammer head bushing wrench* (fig. 195) is a special face type spanner wrench which is used to remove the bushing from the rammer head.

- g. The *rammer head gland wrench* (fig. 195) is a special two-end combination spanner type wrench. It is used in removing the rammer head gland.

- h. The *rammer spring cylinder head wrench* (fig. 196) is a face type spanner wrench which is about eight inches long. It is used to remove the spring cylinder head which is on the rammer head assembly.

- i. The *recoil cylinder packing nut wrench* (fig. 195) is a special hook type spanner wrench which is slipped on from the end of the nut rather than hooked over the nut the usual way. It is used on the recoil cylinder packing nut.

- j. The *closing spring adjusting nut wrench* (fig. 196) is a pin type

### SPARE PARTS AND ACCESSORIES

spanner wrench used on the adjusting nut to adjust the compression of the breech counterbalance spring.

k. The *reducing valve wrench* (fig. 196) is a socket wrench with a T-shaped handle. It is used on the adjusting screw of the breech mechanism reducing valve which reduces the air pressure that is used in closing the breech.

l. The *ratchet wrench* (fig. 194), which is about 20 inches long, is used with the removable primer seat wrench in replacing or removing a primer seat in the obturator spindle.

m. The *pressure plug wrench* (fig. 195) is a box wrench (1.52-inch hexagon). It has a 1 $\frac{3}{8}$ -inch handle. It is used on the pressure plugs in the obturator.

n. The *hinge pin bushing and recuperator pull rod nut wrench* (fig. 196) is a face type spanner wrench used to remove the breechblock carrier hinge pin bushing and the recuperator pull rod nut.

o. The *firing pin bushing wrench* (fig. 195) is a special spanner type wrench which is used to remove the firing pin bushing.

p. The *obturator nut wrench* (fig. 196) is a  $\frac{3}{8}$ -inch steel rod, shaped to form a handle reinforced by a cross bar. The two ends of the rod fit into the two holes in the obturator nut. The wrench is used for tightening and loosening the obturator nut.

q. The *carrier buffer body head wrench* (fig. 196) is a face type spanner wrench used to remove the head of breechblock carrier buffer body.

r. The *carrier buffer head gland wrench* (fig. 196) is a face type spanner wrench which is used to remove the breechblock carrier buffer head gland.

s. The *buffer plunger gland wrench* (fig. 196) is a special face type spanner wrench about six inches long and it is used to remove the buffer plunger gland located on the breech mechanism operating lever buffer

**16-INCH SEACOAST GUN MATERIEL  
GUN MK. II M1; BARBETTE CARRIAGE M4**

**Section XII**

**MATERIEL AFFECTED BY GAS (DECONTAMINATION)**

	Paragraph
Protective measures .....	89
Cleaning .....	90
Decontamination .....	91

**89. PROTECTIVE MEASURES.**

a. When materiel is in constant danger of gas attack, unpainted metal parts will be lightly coated with engine oil. Instruments are included among the items to be protected by oil from chemical clouds or chemical shells, but ammunition is excluded. Care must be taken that the oil does not touch the optical parts of instruments or leather or canvas fittings. Materiel not in use will be protected with covers as far as possible. Ammunition will be kept in sealed containers.

b. Ordinary fabrics offer practically no protection against mustard gas or lewisite. Rubber and oilcloth, for example, will be penetrated within a short time. The longer the period during which they are exposed, the greater the danger of wearing these articles. Rubber boots worn in an area contaminated with mustard gas may offer a grave danger to men who wear them several days after the bombardment. Impermeable clothing will resist penetration more than an hour, but should not be worn longer than this.

**90. CLEANING.**

a. All unpainted metal parts of materiel that have been exposed to any gas except mustard and lewisite must be cleaned as soon as possible with SOLVENT, dry-cleaning, or ALCOHOL, denatured, and wiped dry. All parts should then be coated with engine oil.

b. The using arm will decontaminate the exterior surfaces, the bore, the breechblock assembly, and all porous attachments such as straps, covers, etc., of artillery field pieces exposed to gas.

c. Ammunition which has been exposed to gas must be thoroughly cleaned before it can be fired. To clean ammunition use AGENT, decontaminating, noncorrosive, or if this is not available, strong soap and cool water. After cleaning, wipe all ammunition dry with clean rags. *Do not use dry powdered AGENT, decontaminating (chloride of lime) (used for decontaminating certain types of materiel on or near ammunition supplies); as flaming occurs through the use of chloride of lime on liquid mustard.*

**91. DECONTAMINATION.**

a. For the removal of liquid chemicals (mustard, lewisite, etc.) from materiel, the following steps should be taken:

**MATERIEL AFFECTED BY GAS (DECONTAMINATION)****(1) PROTECTIVE MEASURES.**

(a) For all of these operations a complete suit of impermeable clothing and a service gas mask will be worn. Immediately after removal of the suit, a thorough bath with soap and water (preferably hot) must be taken. If any skin areas have come in contact with mustard, if even a very small drop of mustard gets into the eye, or if the vapor of mustard has been inhaled, it is imperative that complete first-aid measures be given within 20 to 30 minutes after exposure. First-aid instructions are given in TM 9-850 and FM 21-40.

(b) Garments exposed to mustard will be decontaminated. If the impermeable clothing has been exposed to vapor only, it may be decontaminated by hanging in the open air, preferably in sunlight, for several days. It may also be cleaned by steaming for two hours. If the impermeable clothing has been contaminated with liquid mustard, steaming for six to eight hours will be required. Various kinds of steaming devices can be improvised from materials available in the field.

**b. Procedure.**

(1) Commence by freeing materiel of dirt through the use of sticks, rags, etc., which must be burned or buried immediately after this operation.

(2) If the surface of the materiel is coated with grease or heavy oil, this grease or oil should be removed before decontamination is begun. SOLVENT, dry-cleaning, or other available solvents for oil should be used with rags attached to ends of sticks.

(3) Decontaminate the painted surfaces of the materiel with bleaching solution made by mixing one part AGENT, decontaminating (chloride of lime), with one part water. This solution should be swabbed over all surfaces. Wash off thoroughly with water, then dry and oil all surfaces.

(4) All unpainted metal parts and instruments exposed to mustard or lewisite must be decontaminated with AGENT, decontaminating, noncorrosive, mixed one part solid to fifteen parts solvent (ACETYLENE TETRACHLORIDE). If this is not available, use warm water and soap. Bleaching solution must not be used, because of its corrosive action. Instrument lenses may be cleaned only with PAPER, lens, tissue, using a small amount of ALCOHOL, ethyl. Coat all metal surfaces lightly with engine oil.

(5) In the event AGENT, decontaminating (chloride of lime), is not available, materiel may be temporarily cleaned with large volumes of hot water. However, mustard lying in joints or in leather or canvas webbing is not removed by this procedure and will remain a constant source of danger until the materiel can be properly decontaminated. All mustard washed from materiel in this manner lies unchanged on the ground, making it necessary that the contaminated area be plainly marked with warning signs before abandonment.

**16-INCH SEACOAST GUN MATERIEL  
GUN MK. II M1; BARBETTE CARRIAGE M4**

(6) The cleaning or decontaminating of materiel contaminated with lewisite will wash arsenic compounds into the soil, poisoning many water supplies in the locality for either men or animals.

(7) Leather or canvas webbing that has been contaminated should be scrubbed thoroughly with bleaching solution. In the event this treatment is insufficient, it may be necessary to burn or bury such materiel.

(8) Detailed information on decontamination is contained in FM 21-40, TM 9-850, and TC 38, 1941, *Decontamination*.

Section XIII

**ARTILLERY, SEACOAST: PRESSURE TESTING**

	Paragraph
Definitions .....	92
Use of pressure gages for seacoast artillery.....	93
Excessive pressures .....	94
Limitations on use of propelling charges.....	95
Maximum permissible pressure.....	96

**92. DEFINITIONS.**

a. *The Elastic Strength Pressure* is the computed internal gas pressure in a gun which, at the section under consideration, will stress the metal in some layer of the wall tangentially up to the minimum elastic limit which is prescribed for the metal from which the member is made.

b. *The Maximum Pressure* is the maximum value of the pressure exerted by the powder gases on the walls of a gun during the firing of a round.

c. *The Rated Maximum Pressure* for any type of gun is that value of the maximum pressure which is specified in the powder specifications as the upper limit of average pressure which may be developed by an acceptable powder in the form of propelling charges which will impart the specified muzzle velocity to the specified projectile.

d. *The Permissible Mean Maximum Pressure* for any type of gun is that value which should not be exceeded by the average of the maximum pressures developed in a series of rounds fired under any service condition.

e. *The Permissible Individual Maximum Pressure* for any type of gun is that value which should not be exceeded by the maximum pressure developed by any individual round under any service condition.

**93. USE OF PRESSURE GAGES FOR SEACOAST ARTILLERY.**

a. *Major Caliber Pressure Gages.* For seacoast cannon equipped for major caliber pressure gages, pressure measurements will be made in all practices with service or target practice ammunition. Copper cylinders should be changed after each shot of trial fire and must be changed after completion of trial fire. Copper cylinders need not be changed between shots of record fire.

b. *Medium or Minor Caliber Gages.* For seacoast cannon using medium or minor caliber gages, pressure measurements will be limited to shots of trial fire. Extreme care must be taken after each round to insure that no gage remains in the bore.

NOTE: Should there be evidence that excessive pressures are being developed, the firing will be stopped and an investigation made to determine the cause.

**16-INCH SEACOAST GUN MATERIEL  
GUN MK. II M1; BARBETTE CARRIAGE M4**

**94. EXCESSIVE PRESSURES.**

- a. Excessive pressures are considered as follows:
- b. When the average of the maximum pressures developed in the individual rounds exceeds the *permissible mean maximum pressure*, or:
- c. When the maximum pressure developed in any individual round exceeds the *permissible individual maximum pressure*.

**95. LIMITATIONS ON USE OF PROPELLING CHARGES.**

a. The propelling charges should not be used in a practice if in the trial shots the mean of the maximum pressure readings exceeds the permissible mean for the particular gun, or the recorded pressure on any round exceeds the permissible individual maximum pressure, or if the difference between the maximum pressures obtained on any two rounds exceed a value equal to 15 percent of the mean of the group. In the latter case, the powder is liable to develop dangerous pressures if firing is continued, or, if not actually unsafe, may give excessive velocity variation which will be reflected into the range dispersion.

b. The propelling charges will not be used in subsequent practices if in the record shots the recorded pressure exceeds by more than 5 percent the *permissible individual maximum pressure*. The 5 percent increase is based upon the assumption that the coppers in the gages have not been changed between individual rounds. Under such conditions gage readings are usually somewhat higher than the pressure on any individual round.

**96. MAXIMUM PERMISSIBLE PRESSURE.**

a. Maximum permissible pressures for various cannon are listed in columns 4, 5 and 6 of the table below. Column 3 lists the rated maximum pressure for each cannon. This pressure is listed in firing tables under the captions "Maximum pressure for which the gun is designed" or "Maximum pressure."

**b. Table of Pressures.**

1	2	3	4	5	6
GUNS	Computed Elastic Strength-Pressure psi	Rated Maximum Pressure psi	Permissible Mean Maximum Pressure psi	Permissible Individual Maximum Pressure psi	Permissible* Maximum Pressure Record Shots psi
16" Gun Mk. II— Mod. 1 (Navy)	50,500	38,000	41,000	43,700	45,600

\*Pressure recorded by a series of rounds without changing coppers.

Section XIV

**STORAGE**

Paragraph  
97

General .....

**97. GENERAL.**

a. When the mount is to remain in a condition of disuse for a considerable time, the finished parts will be coated with a protective coating of COMPOUND, rust preventive, and the various mechanisms will be thoroughly lubricated in accordance with instructions outlined in section IV.

(1) Examination will be made of all covers and other closing devices to insure that they are securely fastened in place to exclude the entrance of moisture and foreign matter from the working parts.

(2) The following parts will be removed from the mount and stored in a safe, dry place at the fortification.

(a) Firing lock (enclosed in firing lock case).

(b) Cable loop with fittings.

(c) Sight lighting cords with fittings.

(d) Firing magnetos with connecting cords and fittings.

(e) Portable lamps with cords and fittings.

(f) During periods of inactivity, as above referred to, the breech and muzzle of the gun should be protected by assembling the breech and muzzle covers provided with the mount.



**16-INCH SEACOAST GUN MATERIEL  
GUN MK. II M1; BARBETTE CARRIAGE M4**

**Section XV**

**LIST OF REFERENCES**

	Paragraph
Standard nomenclature lists.....	98
Firing tables .....	99
Technical manuals .....	100
Army regulations .....	101
Explanatory publications .....	102

**98. STANDARD NOMENCLATURE LISTS.**

**a. Ammunition.**

Separate loading projectiles, for harbor defense, etc.....	SNL P-3
Separate loading propelling charges for harbor defense, etc....	SNL P-4
Fuzes, primers, blank ammunition, etc.....	SNL P-7
Ammunition instruction material, etc.....	SNL P-8

**b. Material, cleaning and preserving.....SNL K-1**

**c. Firing tables .....**SNL F-69

**d. Fire-control Equipment.**

Computer, gun data, M1.....	SNL F-203
System, data transmission, M5.....	SNL F-190
Mount, telescope, M35; Telescope, M31.....	SNL F-234
Clinometer, M1912 .....	SNL F-98
Board, adjustment, fire, M1 .....	SNL F-116
Board, correction, range, M1A1 .....	SNL F-81
Board, deflection, M1 .....	SNL F-19
Board, plotting, M4 .....	SNL F-185
Board, spotting, M3 .....	SNL F-201
Corrector, percentage, M1.....	SNL F-103
Finder, depression position, M1 .....	SNL F-111
Indicator, wind component, M1.....	SNL F-56
Instrument, azimuth, M1910A1.....	SNL F-84
Rule, set forward, type B.....	SNL F-57
Telescope, observation, M1908.....	SNL F-92

**e. Gun Materiel.**

Major items of railway and permanent and semipermanent artillery .....	SNL E-1
Gun, 16-in., Mk. II, Mod. 1, Navy and carriage, barbette, 16-in., M4 .....	SNL E-20

Current Standard Nomenclature Lists are as tabulated here.

An up-to-date list of SNL's is maintained as the Ordnance  
Publications for Supply Index.....OPSI

**LIST OF REFERENCES**

**99. FIRING TABLES.**

a. Gun, 16-inch, Mk. II Mod. 1 (Navy):

Projectile, A.P., 2,100-lb., Mk. II, mod. 2, 16-in.....	} FT 16-D-1
Projectile, C.I., 2,100-lb., M100, 16-in.....	
Projectile, A.P., empty, for sand loading, 2,100-lb., Mk. II, mod. 2, 16-in.....	
Projectile, A.P., 2,240-lb., Mk. XI.....	FT 16-E-1
Current firing tables are as tabulated here. An up-to-date list of firing tables is maintained in.....	SNL F-69

**100. TECHNICAL MANUALS.**

Field artillery fire-control instruments.....	TM 6-220
Ammunition, general.....	TM 9-1900
Ordnance maintenance plotting boards for seacoast artillery.....	TM 9-1570

**101. ARMY REGULATIONS.**

Range regulations for firing ammunition in time of peace....	AR 750-10
Ordnance field service in time of peace.....	AR 45-40

**102. EXPLANATORY PUBLICATIONS.**

Seacoast artillery fire control and position finding.....	FM 4-15
---	---------

a. Maintenance.

Seacoast and railway artillery ammunition, and field artillery ammunition for large calibers, including 155-mm gun and above.....	OFSB 3-2
---	----------

**16-INCH SEACOAST GUN MATERIEL  
GUN MK. II M1; BARBETTE CARRIAGE M4**

**INDEX**

A	Page No.		Page No.
Accessories (See Spare parts and accessories)		painting and marking.....	272-273
Accidents, field report of ammunition.	285	weight markings.....	273
Adjustment (See Inspection and adjustment)		nomenclature, standard.....	270
Air compressor		packing.....	283-285
care and preservation.....	197-198	preparation for firing.....	275
checking oil in.....	198	primers.....	281-283
filter elements.....	197	projectiles.....	275
general.....	197	general.....	275
lubrication.....	197	table of data.....	276
operation.....	197-198	propelling charges.....	276-280
relay valves.....	197	subcaliber.....	285
description and functioning.....	78-79	Ammunition truck, 16-inch, M4..	287-288
operation of.....	166-172	Ammunition trucks, used for conveyance to rammer trough.....	140
buttons for.....	166	Antifriction device.....	205
Air compressor assembly, lubrication.....	201c-d, 201f	Arm guide.....	17
Air compressor unit, breechblock carrier.....	31-36	Artillery gun book.....	288
Air pipe line.....	204	Assembly and disassembly	
Air pressure in:		electrical equipment.....	266-268
air compressor		firing lock.....	268
maintenance of.....	167	firing magnetos.....	268
recuperators		general.....	266
checking.....	155-158	main distribution box.....	267
inspection.....	205	motor controllers.....	267
Air reducing and closing valves..	153-154	portable hand lamps.....	267
Air reducing valve.....	203	power loop.....	267
Ammunition		push-button stations.....	267
authorized rounds.....	274-275	sight lighting plugs and plug boxes.....	267
table.....	274-275	transformers.....	267
care, handling, and preservation.....	273-274	gun, carriage, and rammer.....	216
classification.....	271	Authorized rounds of ammunition.....	274-275
cleaning.....	308	"Automatic" air compressor button..	166
delivery to rammer.....	140	Automatic elevating stops, gun.....	12
field report of accidents.....	285	Azimuth circle, base ring group (carriage).....	46
firing tables.....	270, 315	Azimuth data indicator (carriage)....	124
fuzes			
boresafe.....	281	<b>B</b>	
general.....	280-281	Base ring group (carriage).....	45-46
general.....	270	Body of the breechblock (carrier)....	23
identification.....	271-273	Bore greasing device, 16-inch, M6	
data card.....	272	description.....	290
general.....	271	method of slushing bore.....	290-292
lot number.....	271-272	Bore sponge cover.....	294
mark or model.....	271	Brake levers, operation of.....	172-177
		Brakes, elevating.....	88-89

## INDEX

B-Cont'd	Page No.	Page No.
Breech closing valve.....	203	Carrier buffer..... 39
Breech cover.....	292-294	Case, rammer..... 139
Breech mechanism		Caution plate..... 17
cleaning.....	152	Chain, rammer..... 139
inspection.....	203	Chamber sponge cover..... 294
lubrication.....	201d, 203	Characteristics of gun and carriage... 7
guide.....	201f	Charges, propelling..... 276-280
operation.....	152	Circuits, malfunctions and corrections
Breech recess.....	202	firing..... 265-266
Breechblock		lighting..... 263-265
description and functioning.....	12	power..... 262-263
inspection.....	202-203	Classification of ammunition..... 271
Breechblock carrier.....	19-39	Cleaning:
Breechblock carrier hinge bearings,		breech mechanism..... 152
lubrication.....	200	gas exposed materiel..... 308
Breechblock handle.....	31	gun bore..... 152
Breechblock opening.....	155	Clearances in cradle trunnion... 178-180
Brushes.....	292	Clutch release, elevating..... 183
		Clutch, traversing..... 121
<b>C</b>		shifter
Cam roller brackets.....	17	description and functioning. 121-122
Cam tripping device.....	183	operation..... 186
Care and preservation		Closing cylinders, breechblock carrier 31
air compressor.....	197-198	Compressed air cylinder M2..... 292
checking oil in air compressor.....	198	Compressor crankcase, checking of oil
filter elements.....	197	in..... 167
general.....	197	Connecting rod, breechblock carrier.. 25
lubrication.....	197	"Continuous" air compressor button.. 166
operation.....	197-198	Control lever, rammer..... 139
relay valves.....	197	Control stations, traversing (carriage) 123
ammunition.....	273-274	Counterrecoil cylinder filling funnel.. 298
carriage.....	194-195	Covers
equipment.....	259-260	bore sponge..... 294
filling devices.....	196	breech..... 292-294
filling hydraulic speed gears with oil	197	chamber sponge..... 294
general.....	192	firing magneto..... 294
gun.....	192-194	muzzle..... 294
lubrication instructions.....	198-201f	Cradle and recoil mechanism group 56-59
trunnion bearings.....	199	cradle..... 56
rammer.....	195	Cradle liners, carriage..... 207
stuffing boxes.....	195-196	Cradle trunnion bearings, lubrication 200
Carriage, Barbette, 16-inch, M4		Cradle trunnion clearances..... 178-180
assembly and disassembly.....	216	Cranks, traversing (carriage)..... 122
care and preservation of.....	194-195	
characteristics.....	7	<b>D</b>
data.....	10-11	Data
description and functioning....	45-124	carriage..... 10-11
inspection.....	204-208	gun..... 9
lubrication guides.....	201a, 201e	Data card, ammunition..... 272
malfunctions, cause and cor-		Data receiver, traversing..... 188
rections.....	212-214	Decontamination of materiel affected
preparing for action.....	155-158	by gas..... 308-310
safety precautions for handling	147-148	

**16-INCH SEACOAST GUN MATERIEL  
GUN MK. II M1; BARBETTE CARRIAGE M4**

**INDEX**

D-Cont'd	Page No.		Page No.
Definition of terms used in pressure testing.....	311	zero indicator device.....	124
Description (See also Description and functioning)		gun.....	12-39
charges.....	276-280	breechblock carrier.....	19-39
spare parts and accessories....	286-307	primers.....	281
Description and functioning		rammer.....	139-140
carriage		Device, interlocking, rammer.....	140
air compressor.....	78-79	Difference in models of carriages.....	7-9
base ring group.....	45-46	Disassembly (See Assembly and disassembly)	
azimuth circle.....	46	Distance ring and traversing roller	
pintle liners.....	46	group (carriage).....	47
traversing rack.....	46	Dummy charge extractor.....	294
cradle and recoil mechanism		Dummy projectile.....	294
group.....	56-59	Dust guards and gear covers, carriage	207
cradle.....	56		
elevating racks.....	59	<b>E</b>	
elevation indicator rack.....	59	Electric power, traversing, operation.....	187-188
liners.....	59	Electrical equipment.....	217-268
loading platform.....	59	assembly and disassembly.....	266-268
piston and yoke rods.....	58	cable loop.....	217-218
recoil cylinder.....	56	firing	
recuperator cylinders.....	56-58	care and preservation.....	259-260
roller bearings.....	59	description and functioning.....	255-258
distance ring and traversing		malfunctions and corrections....	261
group.....	47	operation.....	258-259
elevating group.....	87-89	general discussion of.....	217
elevating brakes.....	88-89	lighting	
elevating buffers.....	89	care and preservation.....	259-260
elevating by hand.....	87	description and functioning.....	245-249
elevating by power.....	87	malfunctions and corrections....	261
elevation pointer.....	87	operation of.....	249-255
range data indicator.....	89	main distribution box.....	218
trunnion roller bearings.....	88	power	
emplacement.....	45	care and preservation.....	259-260
racer group.....	47	description and functioning.....	218-233
recoil and counterrecoil.....	55	malfunctions and corrections....	261
shield.....	59	operation of.....	233-245
side frames and transom groups.....	55	Elevating and depressing the gun	
traversing group.....	121-124	operation.....	172-183
azimuth data indicator.....	124	speeds.....	181
clutch.....	121	Elevating brakes	
clutch shifter.....	121-122	description and functioning.....	88-89
control stations.....	123	inspection.....	206
cranks.....	122	operation.....	174-177
gear-friction box assembly.....	121	Elevating buffers.....	89
limit switch.....	123-124	Elevating clutch shifter lever, setting	
pinion and rack.....	121	by hand.....	172-174
slow-motion handwheels.....	122	Elevating group (carriage).....	87-89
speed gear.....	122-123	Elevating handwheel.....	177

## INDEX

E-Cont'd	Page No.		Page No.
Elevating hydraulic speed gear, lubrication guide.....	201f	Guides, lubrication ( <i>See under Lubrication</i> )	
Elevating racks.....	59	Gun book.....	288
Elevating the carriage by hand and power.....	87	Gun bore.....	152
inspection.....	206	Gun key.....	12
Elevating the gun by:		Gun, 16-inch, Mk. II, M1	
hand.....	172-180	assembly and disassembly.....	216
power.....	180-183	care and preservation of.....	192-194
Elevation indicator rack.....	59	data.....	9
Elevating mechanism, lubrication.....	201b, 201c	description and functioning.....	12-39
Elevation pointer		elevating by:	
description and functioning.....	87	hand.....	172-180
operation.....	180	power.....	180-183
Emplacement of carriage.....	45	inspection.....	202-204
Extractors.....	294	malfunctions, cause and correction.....	209-212
Eyebolts.....	294-298	preparing the.....	152-155
		safety precautions for handling	147-148
		<b>F</b>	<b>H</b>
Field report of ammunition accidents.....	285	Hand extractor.....	294
Filling devices, care of.....	196	Hand power, loading by.....	190-191
Filling hydraulic speed gears with oil.....	197	Hand rammer.....	298-300
Filter elements.....	197	Handwheel, follow-up control... ..	181-183
Firing ammunition, preparation for... ..	275	Handwheels, slow motion traversing carriage	
Firing charges, preparation for.....	278	description and functioning.....	122
Firing circuit, malfunctions and corrections.....	265-266	operation.....	186
Firing equipment		Holding bolts, inspection	
care and preservation.....	259-260	carriage.....	208
description and functioning... ..	255-258	gun.....	204
malfunctions and corrections.....	261	rammer.....	208
operation.....	258-259	Holding-down latch.....	23
Firing lock		Hydraulic cylinders.....	204
assembly and disassembly.....	268	Hydraulic speed gears.....	197
inspection and operation test.....	155	Waterbury, lubrication....	200, 201b-c
Firing magneto cover.....	294		
Firing magnetos.....	268	<b>I</b>	
Firing mechanism, lubrication.....	201b	Identification of ammunition... ..	271-273
Firing tables.....	270, 315	Indicator, traversing control... ..	186-187
Follow-up control handwheel... ..	181-183	Inspection and adjustment.....	202-208
Foot treadles.....	186	carriage.....	204-208
Funnels.....	298	air pressure in recuperators.....	205
Fuzes.....	280-281	antifriction device.....	205
		cradle liners.....	207
		dust guards and gear covers... ..	207
		elevating brakes.....	206
		elevating by hand and power... ..	206
		holding bolts.....	208
		liquid indicators.....	205-206
		liquid pressure in recuperators... ..	205
		lubricating devices.....	207
		lubrication of gun and cradle... ..	207
		recoil cylinder.....	207
		<b>G</b>	
Gages.....	298		
pressure, use of for seacoast artillery	311		
Gas ejector, valve, inspection.....	203		
Gas, materiel affected by			
cleaning.....	308		
decontamination.....	308-310		
protective measures.....	308		
Gear-friction box assembly, traversing	121		

**16-INCH SEACOAST GUN MATERIEL  
GUN MK. II M1; BARBETTE CARRIAGE M4**

**INDEX**

I-Cont'd	Page No.		Page No.
Inspection and Adjustment—Cont'd		Loading mechanism, lubrication	
carriage—cont'd		guide . . . . .	201c, 201f
roller path and traversing rollers	204	Loading platform . . . . .	59
speed-gear expansion tanks . . . . .	207	Loading position pointer . . . . .	177-178
stuffing boxes . . . . .	208	Loading trough . . . . .	140
tools and accessories . . . . .	208	spring compressing screws . . . . .	300
traversing by:		Lot number, ammunition . . . . .	271-272
electric-power . . . . .	204-205	Lower end of breechblock carrier . . . . .	19
hand . . . . .	204	Lubricating devices, inspection . . . . .	207
general discussion of . . . . .	202	Lubrication	
gun		air compressor . . . . .	197
air pipe line . . . . .	204	breech mechanism . . . . .	203
air reducing valve . . . . .	203	guide(s) . . . . .	199
breech closing valve . . . . .	203	air compressor . . . . .	201c, 201f
breech mechanism . . . . .	203	breech mechanism . . . . .	201b, 201f
breech recess . . . . .	202	elevating hydraulic speed gear . . . . .	201f
breechblock . . . . .	202-203	left side of carriage . . . . .	201e
gas ejector system . . . . .	203	loading mechanism . . . . .	201c, 201f
gas ejector valve . . . . .	203	right side of carriage . . . . .	201a
holding bolts . . . . .	204	top view of gun and floor plate . . . . .	201
hydraulic cylinders . . . . .	204	inspection of gun and cradle . . . . .	207
oil gage . . . . .	203	instructions . . . . .	198-201f
Intake air filters, air compressor . . . . .	167-172		
Interlocking device, rammer . . . . .	140	<b>M</b>	
Intervals of lubrication . . . . .	201b, 201c	Main distribution box . . . . .	267
<b>K</b>		Malfunctions and corrections	
Keyway for shield lock, carriage . . . . .	59	carriage . . . . .	212-214
<b>L</b>		electrical equipment . . . . .	261-266
Lighting circuit . . . . .	263-265	firing . . . . .	261
Lighting equipment		circuit . . . . .	265-266
care and preservation . . . . .	259-260	general . . . . .	261
description and functioning . . . . .	245-249	lighting . . . . .	261
malfunctions and corrections . . . . .	261	circuit . . . . .	263-265
operation of . . . . .	249-255	power . . . . .	261
Limit switch, traversing (See limit switch <i>under</i> Traversing)		circuit . . . . .	262-263
Limits of traverse in elevating the gun	186	general discussion of . . . . .	209
Liners for cradle of (carriage) . . . . .	59	gun . . . . .	209-212
Liquid, filling and replenishing recuperator cylinders with . . . . .	158-164	rammer . . . . .	215
Liquid indicators, carriage . . . . .	205-206	Mark or model of ammunition . . . . .	271
Liquid pressure in recuperators . . . . .	158-164	Materiel affected by gas (See Gas, materiel affected by)	
inspection . . . . .	205	Metal parts exposed to gas, cleaning . . . . .	308
Loading		Misfires, cause of . . . . .	261
powder by:		Models of carriages, difference in . . . . .	7-9
hand power . . . . .	190-191	Motor controllers . . . . .	267
motor power . . . . .	190	Motor power	
projectile by motor power . . . . .	188-190	loading powder by . . . . .	190
Loading angle . . . . .	140	loading projectiles by . . . . .	188-190
		Mount, storage of . . . . .	313
		Muzzle cover . . . . .	294

## INDEX

N	Page No.	Page No.
Nomenclature, standard, use of for ammunition.....	270	
<b>O</b>		
Oil, checking in:		
air compressor.....	198	
compressor crankcase.....	167	
Oil can points, lubrication.....	201c, 201d	
Oil gage.....	203	
Oil screw plugs and fittings, lubrication.....	201b, 201c	
Opening breechblock.....	155	
Operating lever, breechblock carrier	23-24	
Operation		
gun and carriage.....	152-188	
air compressor.....	166-172	
care in.....	197-198	
elevating the gun by hand..	172-180	
elevating the gun by power..	180-183	
filling and replenishing recuperator cylinders with liquid..	158-164	
filling recoil cylinder.....	164-165	
firing lock.....	155	
preparing the carriage for action.....	155-158	
preparing the gun.....	152-155	
traversing by electric power.	187-188	
traversing the mount by hand.....	183-187	
rammer.....	188-191	
hand and motor.....	139	
loading ( <i>See Loading</i> )		
<b>P</b>		
Packing ammunition.....	283-285	
Painting and marking, ammunition.....	272-273	
Parking table of rammer.....	139	
Pinion and rack, traversing.....	121	
Pintle liners, base ring group.....	46	
Piston and yoke rods, carriage.....	58	
Platform, racer group ( <i>carriage</i> )		
brackets.....	47	
inner and outer.....	47	
Plumber's force pump.....	300	
Portable hand lamps.....	267	
Power, elevating carriage by.....	87	
Power circuit.....	262-263	
Power equipment		
care and preservation.....	259-260	
description and functioning... ..	218-233	
malfunctions and corrections.....	261	
operation of.....	233-245	
Power extractor (for dummy projectile).....	294	
Power loading rammer by motor and hand.....	188-191	
Power loop.....	267	
"Power" setting the elevating clutch shifter at.....	180	
Precautions, safety, for handling gun, carriage, and rammer.....	147-148	
Pressure gages, use of for seacoast artillery.....	311	
Pressure in recuperators, checking		
air.....	155-158	
liquid.....	158-164	
Pressure reducing gas ejector and breech closing valves.....	36-39	
Pressure testing.....	311-312	
definitions.....	311	
pressure gages.....	311	
pressures, maximum permissible and excessive.....	312	
propelling charges, limitation and use of.....	312	
table of pressures.....	312	
Primer, combination electric and percussion, Mk. XV Mod. 1.....	281-283	
Primers, description and use.....	281	
Projectiles.....	275	
Propelling charges.....	276	
gages.....	298	
limitation on use of.....	312	
Push-button stations.....	267	
<b>R</b>		
Racer group, carriage.....	47	
Rammer		
assembly and disassembly.....	216	
care and preservation of.....	195	
description and functioning... ..	139-140	
ammunition.....	140	
trucks.....	140	
case.....	139	
chain.....	139	
control lever.....	139	
head.....	139	
interlocking device.....	140	
loading angle.....	140	
loading trough.....	140	
operation by hand or motor... ..	139	
parking table.....	139	
shot tongs.....	140	
unstroking device.....	139	
inspection.....	208	
malfunction, cause and correction..	215	



**16-INCH SEACOAST GUN MATERIEL  
GUN MK. II M1; BARBETTE CARRIAGE M4**

**INDEX**

R-Cont'd	Page No.	Page No.
Rammer—cont'd.		
operation.....	188-191	
"ram" position of.....	189	
safety precautions for handling	147-148	
Range data indicator.....	89	
Reamers.....	300	
Recoil and counterrecoil of gun.....	55	
Recoil cylinder		
checking of stuffing box for leaking	195	
description and functioning.....	56	
filling.....	164-165	
funnel		
care and preservation.....	196	
description and use.....	298	
inspection.....	207	
Recuperator cylinders		
care and preservation.....	196	
checking for oil leaks.....	195	
description and functioning.....	56-58	
filling and replenishing liquid		
with.....	158-164	
Recuperators		
air pressure		
checking.....	155-158	
inspection.....	205	
liquid pressure		
checking.....	158-164	
inspection.....	205	
Reducing valve lifting bolt.....	300	
Relay valves		
cleaning.....	197	
leakage in.....	166-167	
Reports and records of lubrication...	200	
Roller bearings (carriage).....	59	
Roller lift hook.....	300	
Roller path and traversing rollers		
(carriage).....	204	
Roller pivots, gun.....	19	
Rotating cam, gun		
description and functioning		
lower.....	14	
upper.....	12	
<b>S</b>		
Safety precautions for handling		
gun, carriage and rammer.....	147-148	
Safety valve, air compressor.....	167	
Salvo latch.....	14-15	
Scrapers		
metal.....	300-302	
steel scraper and socket.....	302	
Screwdrivers.....	302	
Seacoast artillery, pressure test-		
ing.....	311-312	
(See Pressure testing)		
Shield, carriage.....	59	
Shot tongs, rammer.....	140, 302	
Side frames and transom groups, car-		
riage.....	55	
Sight lighting plugs and plug boxes...	267	
Slow-motion handwheels.....	186	
Slushing method for bore.....	290-292	
Spare parts and accessories.....	286-307	
ammunition truck, 16-inch M4	287-288	
artillery gun book.....	288	
bore greasing device 16-inch,		
M6.....	290-292	
brushes.....	292	
compressed air cylinder M2.....	292	
covers.....	292-294	
dummy projectile.....	294	
extractors.....	294	
eyebolts.....	294-298	
funnels.....	298	
gages.....	298	
hand rammer.....	298-300	
loading trough spring compressing		
screws.....	300	
plumber's force pump.....	300	
reamers.....	300	
reducing valve lifting bolt.....	300	
roller lift hook.....	300	
scrapers.....	300-302	
screwdrivers.....	302	
shot tongs.....	302	
sponge prop.....	302-303	
sponge tub.....	303	
sponges.....	302	
staves.....	303	
torsion washer assembly pins...	303-306	
vent cleaning bit.....	306	
wrenches.....	306-307	
Speed gear, traversing.....	122-123	
Speed-gear expansion tanks.....	207	
Speeds for elevating and depressing		
gun.....	181	
Sponge prop.....	302-303	
Sponge tub.....	303	
Sponges.....	302	
"Start" button for elevating gun....	181	

INDEX

S-Cont'd	Page No.	Page No.	
Staves.....	303	control indicator.....	186
Storage of mount.....	313	control stations.....	123
Stuffing boxes		cranks.....	122, 183-186
care and preservation of.....	195-196	data receiver.....	188
inspection.....	208	gear-friction box assembly.....	121
Subcaliber ammunition.....	285	limit switch.....	123-124
Switch, traversing limit ( <i>See under</i> Traversing)		operation by electric power.....	187
		pinion and rack.....	121
		rack, base ring group.....	46
		rollers.....	47
		slow-motion handwheels.....	122
		speed gear.....	122-123
		Traversing the mount by:	
		electric power.....	187-188
		hand.....	183-187
		Trunnion (roller) bearings	
		description and functioning.....	88
		lubrication.....	199
		<b>V</b>	
		Vent cleaning bit.....	306
		Vent cock, interstage cooler, air com- pressor.....	166
		<b>W</b>	
		Waterbury hydraulic speed gears, lu- brication.....	200, 201b, 201d
		Weight markings, ammunition.....	273
		"Withdraw" position of rammer.....	190
		Wrenches.....	306-307
		<b>Z</b>	
		Zero indicator device.....	124

[ A.G. 062.11 (9-19-42)  
O.O. 461/23577 O.O. (10-21-42)  
TT GRA WAO 3 Nov. 17 2000 1942 ]

BY ORDER OF THE SECRETARY OF WAR:

G. C. MARSHALL,  
*Chief of Staff.*

OFFICIAL:

J. A. ULIO,  
*Major General,*  
*The Adjutant General.*

DISTRIBUTION:

CA Dists. (3); HD Hq. (6); IR 4(5); R 9(2); IBn 4(3), 9(1);  
IC 4(6), 9(4)  
(For explanation of symbols, see FM 21-6)



Section VIII  
**ELECTRICAL EQUIPMENT**

	Paragraph
General .....	29
Description and functioning of power equipment.....	30
Operation of power equipment.....	31
Description and functioning of lighting equipment.....	32
Operation of lighting equipment.....	33
Description and functioning of firing equipment.....	34
Operation of firing equipment.....	35
Care and preservation of power, lighting, and firing equipment..	36
Inspection .....	37
Malfunctions and corrections.....	38
Assembly and disassembly.....	39

**29. GENERAL.**

a. The electrical equipment for the M4 mount consists of power circuits, lighting circuits and firing circuits.

(1) Current for power and lighting is brought to the emplacement by means of cables which terminate in special receptacles located in a recess in the emplacement well.

(2) The current is generated at the fortifications by means of Diesel engine generators.

(3) Current for power and lighting is delivered to the receptacles on the emplacement through two cables either of which may be used independently. From this point it is carried through a cable loop and receptacle on the front segment of the racer to the main distribution box located under the inner platform on the right side of the mount.

(4) Power for the firing circuit is generated on the mount by means of firing magnetos located on the right and left sides of the carriage.

b. **Cable Loop.** A cable loop (fig. 149) approximately 24 feet in length, designed for carrying the power and lighting current from the receptacle (E, fig. 150) on the emplacement to an identical receptacle on the racer is provided. This cable is of sufficient length to compensate for the traversing movement of the mount to extremes of position to the right and left of the center line of fire, without strain or fracture of the cable and connecting parts.

(1) The cable is provided at each end with three-wire, three-pole, 600-volt a-c commercial receptacle plugs (C, fig. 150) equipped with a retaining nut (D, fig. 150) which must be screwed onto the receptacle when the loop is assembled.

**16-INCH SEACOAST GUN MATERIEL  
GUN MK. II M1; BARBETTE CARRIAGE M4**

(2) Hook clamps (A, fig. 150) are assembled on the cable to which chain snap fastenings are assembled. These fastenings are assembled to brackets on the wall of the emplacement and to the racer body (fig. 149) and are intended to sustain the weight of the cable and relieve the strain on the receptacle plugs.

(a) The cable end having the hook clamp located approximately 18 inches from the cable plug is assembled to the receptacle on the racer. The end having the hook clamp approximately 31 inches from the cable plug is assembled to one of the receptacles on the emplacement.

(3) The ends of the receptacles on the racer and emplacement are provided with closing caps (J, fig. 150) to be screwed onto the ends of the receptacles when the plugs are removed.

(4) Duplicate receptacles (fig. 149) are assembled side by side in the foundation recess at the front of the mount to insure a continuous flow of current to the emplacement in case one of the cables becomes unserviceable.

(a) In the event of injury to either of the main feeder cables, the other may be employed by changing the receptacle plug from the "DEAD" line receptacle to the active line receptacle continuing an uninterrupted flow of current to the power and lighting devices on the mount.

(5) A feeder cable and cable loop for conveying electrical data to the elevating and traversing data receivers is under development and will be connected to the mount when completed. Location of the receptacles for the cable and loop, when assembled, is indicated by dots on figure 149.

**c. Main Distribution Box.** The main feeder cable leading from the receptacle located on the front segment of the racer enters the main distribution box (G, fig. 151) and (fig. 152) through a watertight connector at the top. The cable is of the three-conductor type, coded red, white, and black. The outside diameter of the cable is 1.67 inches and the total length is approximately 19 feet. The cable is divided inside the distribution box and is attached to three parallel bars (K, L and N, fig. 152) from which position the current is distributed to the power and lighting cables.

(1) Four of the cables leading from the main distribution box carry current for power. The fifth cable leads to the main lighting transformer (E, fig. 151) and (fig. 153) located under the right platform.

**30. DESCRIPTION AND FUNCTIONING OF POWER EQUIPMENT.**

**a. Motor Speed Gears and Controllers.** From the main distribution box 440-volt current is supplied to all motors through their respective controllers.

ELECTRICAL EQUIPMENT

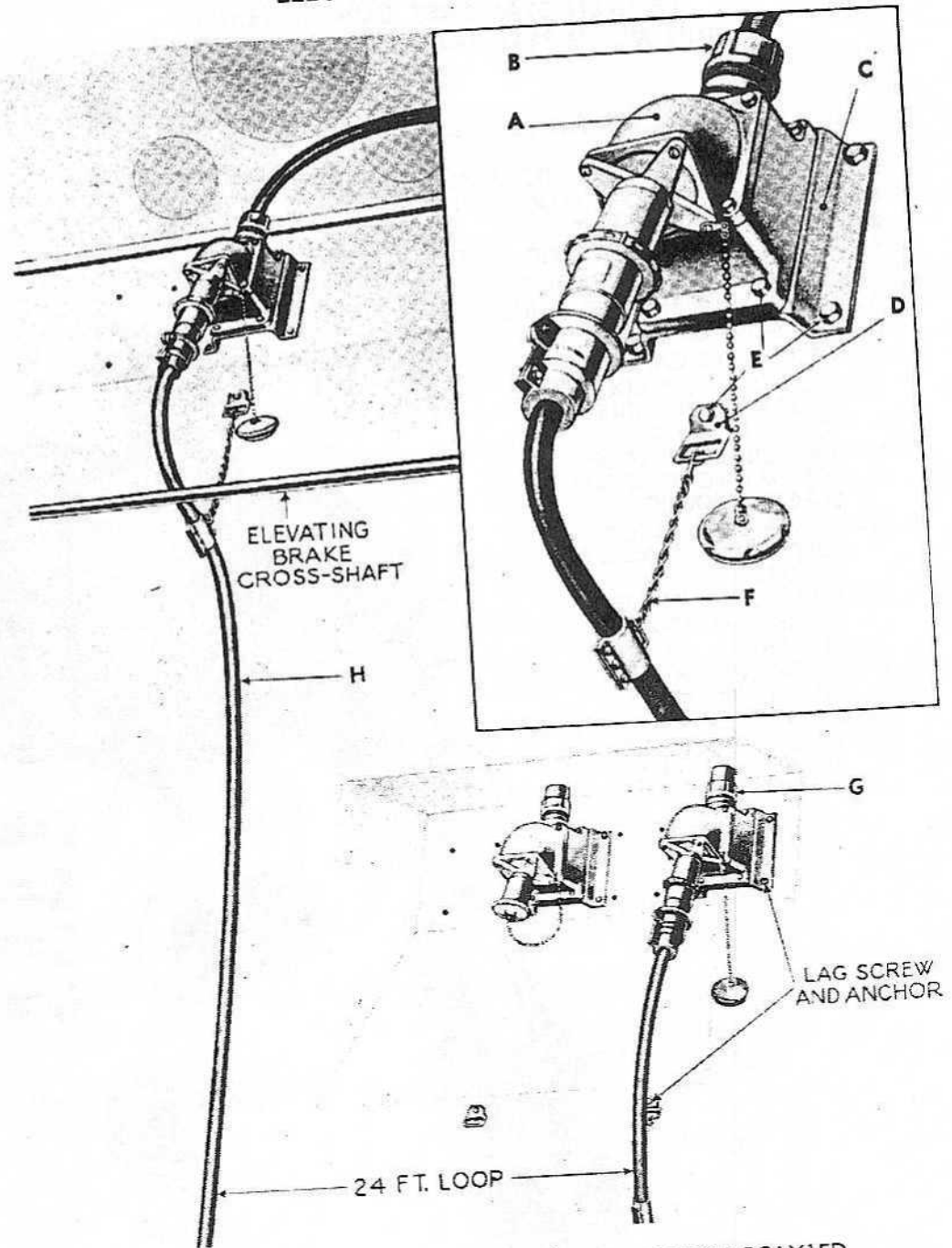

- A—CABLE LOOP RECEPTACLE C54676 WITH SCREW BCAX1CC
- B—POWER CABLE CONNECTOR B162517
- C—RECEPTACLE BRACKET B162575
- D—SUPPORT BRACKET B162579
- E—SCREW BCAX1ED
- F—CABLE SUPPORT CHAIN ASSEMBLY C54687
- G—CONNECTOR UNION B18711E
- H—CABLE LOOP (ASSEMBLY) D42364

RA PD 3882

Figure 149—Arrangement of Cable Loops for Power and Data Transmission

**16-INCH SEACOAST GUN MATERIEL  
GUN MK. II M1; BARBETTE CARRIAGE M4**

- A—CLAMP B162577 (OF THE LOOP SUPPORTING CHAIN-ASSEMBLY D42364)
- B—(CABLE CLAMP) SCREW BCAX1AE AND NUT BBAX1A
- C—POWER CABLE LOOP PLUG C54686
- D—PLUG RETAINING NUT
- E—POWER CABLE LOOP PLUG RECEPTACLE C54676
- F—CONNECTOR B162517 (WITH NEOPRENE BUSHING)
- G—RECEPTACLE BRACKET B162575
- H—(RECEPTACLE) SCREW BCAX1CC
- J—RECEPTACLE CAP
- K—(POWER CABLE LOOP PLUG RECEPTACLE BRACKET) SCREW BCAX1ED
- L—(POWER CABLE LOOP SUPPORTING BRACKET) SCREW BCAX1ED
- M—POWER CABLE LOOP SUPPORTING BRACKET B162579
- N—(LOOP SUPPORTING CHAIN) SNAPBOLT SPFX1AA
- P—(LOOP SUPPORTING CHAIN) "S" HOOK SCAX1H
- Q—(LOOP SUPPORTING CHAIN) SDAX1B

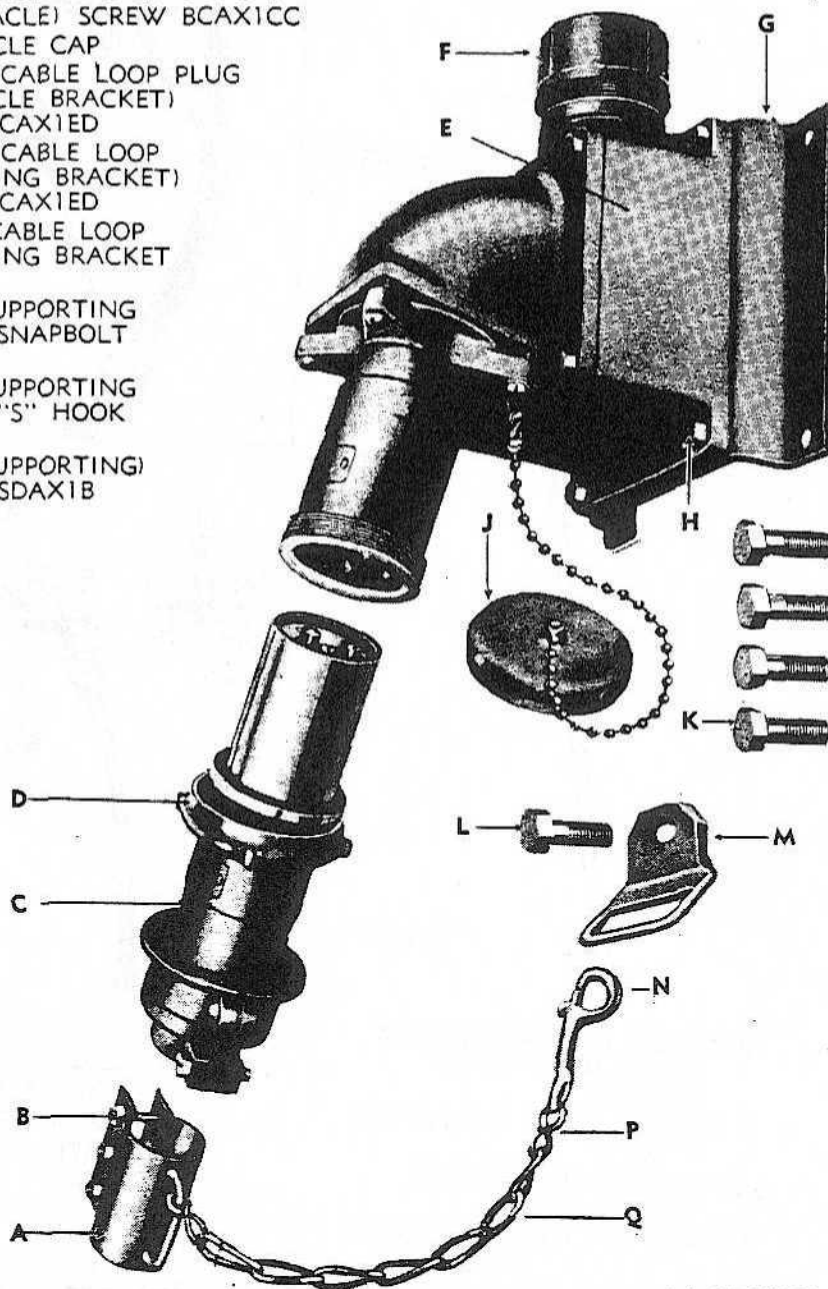

RA PD 38830

**Figure 150—Power Cable Loop Plug—Receptacle and Supporting Chain**

ELECTRICAL EQUIPMENT

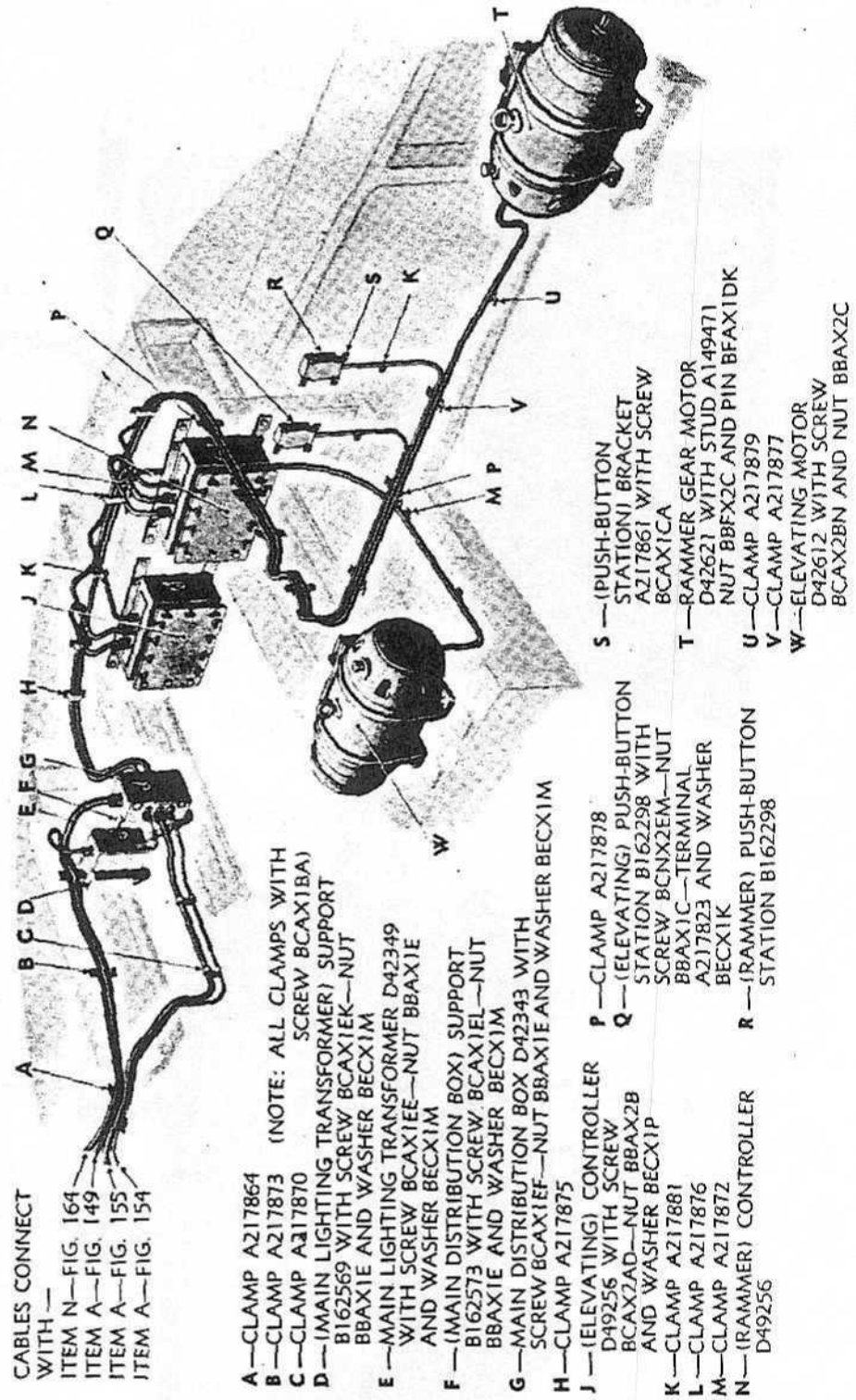

CABLES CONNECT WITH —  
ITEM N—FIG. 164  
ITEM A—FIG. 149  
ITEM A—FIG. 155  
ITEM A—FIG. 154

- A—CLAMP A217864
- B—CLAMP A217873 (NOTE: ALL CLAMPS WITH SCREW BCAX1BA)
- C—CLAMP A217870
- D—(MAIN LIGHTING TRANSFORMER) SUPPORT B162569 WITH SCREW BCAX1EK—NUT BBAX1E AND WASHER BECX1M
- E—MAIN LIGHTING TRANSFORMER D42349 WITH SCREW BCAX1EE—NUT BBAX1E AND WASHER BECX1M
- F—(MAIN DISTRIBUTION BOX) SUPPORT B162573 WITH SCREW BCAX1EL—NUT BBAX1E AND WASHER BECX1M
- G—MAIN DISTRIBUTION BOX D42343 WITH SCREW BCAX1EF—NUT BBAX1E AND WASHER BECX1M
- H—CLAMP A217875
- J—(ELEVATING) CONTROLLER D49256 WITH SCREW BCAX2AD—NUT BBAX2B AND WASHER BECX1P
- K—CLAMP A217881
- L—CLAMP A217876
- M—CLAMP A217872
- N—(RAMMER) CONTROLLER D49256
- P—CLAMP A217878
- Q—(ELEVATING) PUSH-BUTTON STATION B162298 WITH SCREW BCNX2EM—NUT BBAX1C—TERMINAL A217823 AND WASHER BECX1K
- R—(RAMMER) PUSH-BUTTON STATION B162298
- S—(PUSH-BUTTON STATION) BRACKET A217861 WITH SCREW BCAX1CA
- T—RAMMER GEAR MOTOR D42621 WITH STUD A149471 NUT BBFX2C AND PIN BFAX1DK
- U—CLAMP A217879
- V—CLAMP A217877
- W—ELEVATING MOTOR D42612 WITH SCREW BCAX2BN AND NUT BBAX2C

RA PD 38631

... .. and Rammer Equipment



TM 9-471  
30

16-INCH SEACOAST GUN MATERIEL  
GUN MK. II M1; BARBETTE CARRIAGE M4

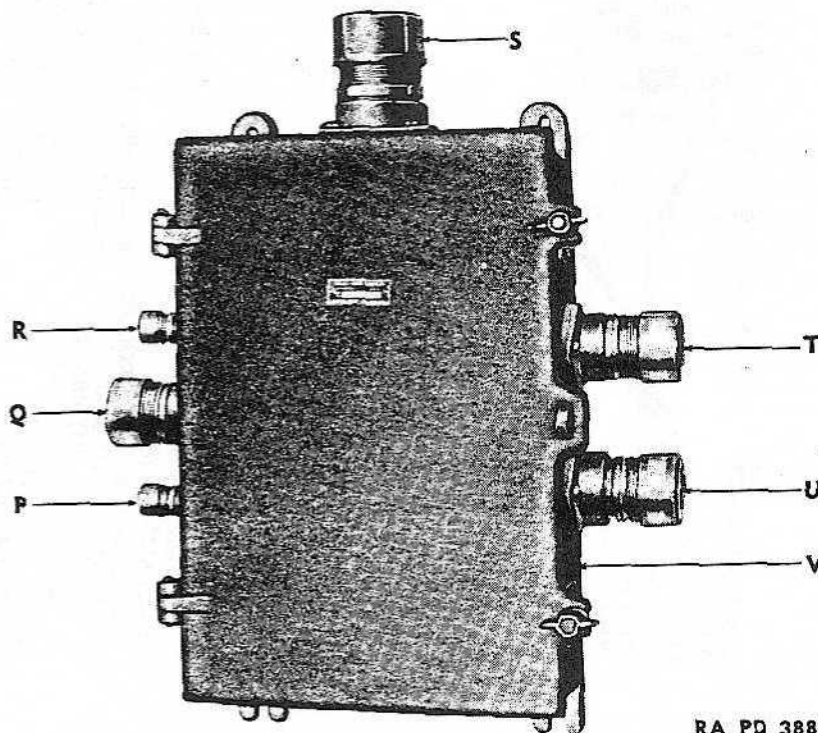
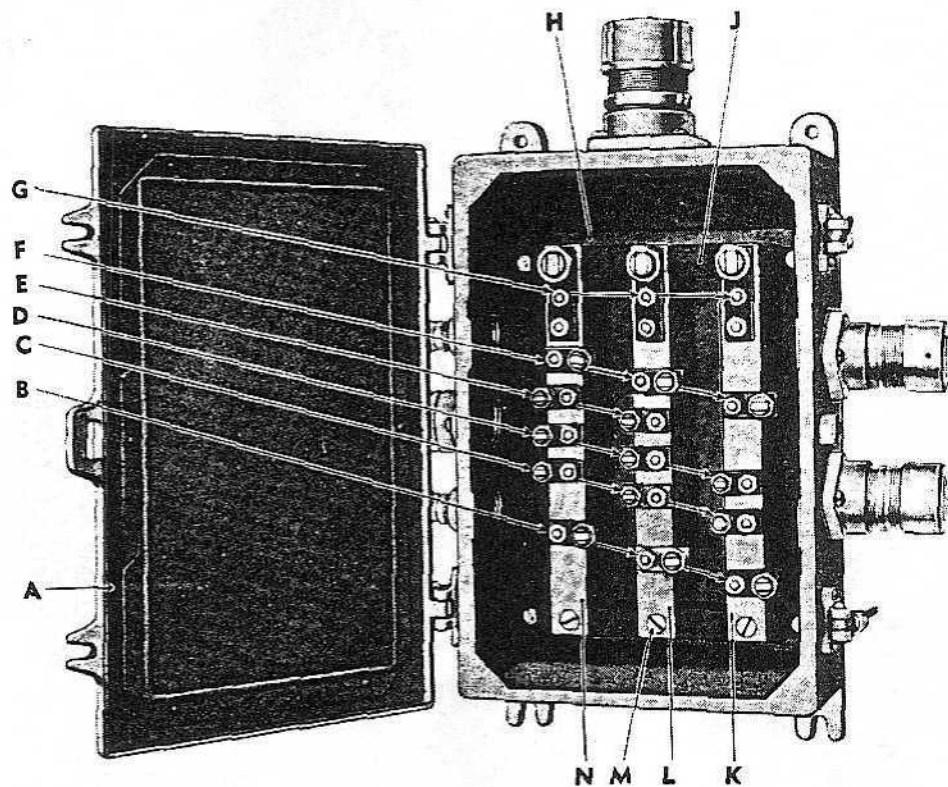

RA PD 38832

Figure 152—Power Panel  
(LEGEND ON OPPOSITE PAGE)

**ELECTRICAL EQUIPMENT**

- A—COVER GASKET
- B—(ELEVATING CABLE) TERMINAL LUG A217802—SCREW BCAX1CB WASHER BECX1K AND NUT BBAX1C
- C—(TRAVERSING CABLE) TERMINAL LUG A217801 SCREW BCAX1CB—WASHER BECX1K AND NUT BBAX1C
- D—(AIR COMPRESSOR CABLE) TERMINAL LUG A217801 SCREW BCAX1CB—WASHER BECX1K AND NUT BBAX1C
- E—(LIGHTING CABLE) TERMINAL LUG A217801—SCREW BCAX1CB WASHER BECX1K AND NUT BBAX1C
- F—(RAMMER CABLE) TERMINAL LUG A217802—SCREW BCAX1CD WASHER BECX1K AND NUT BBAX1C
- G—(FEEDER CABLE) TERMINAL LUG A217803—SCREW BCAX1CC WASHER BECX1K AND NUT BBAX1C
- H—INSULATION PLATE C87093
- J—BUSS BAR DISTANCE PLATE B162521—SCREW BCAX1CD AND WASHER BECX1K
- K—BUSS BAR B162520
- L—BUSS BAR B162519
- M—(BUSS BAR) SCREW BCKX4DK
- N—BUSS BAR B162518
- P—(TRAVERSING CABLE) CONNECTOR B162514
- Q—(AIR COMPRESSOR CABLE) CONNECTOR B162515
- R—(LIGHTING CABLE) CONNECTOR B162514
- S—(FEEDER CABLE) CONNECTOR B162517
- T—(RAMMER CABLE) CONNECTOR B162515
- U—(ELEVATING CABLE) CONNECTOR B162516
- V—POWER PANEL BODY D42342

RA PD 3883

**Legend for Figure 152—Power Panel**  
(ILLUSTRATION ON OPPOSITE PAGE)

16-INCH SEACOAST GUN MATERIEL  
GUN MK. II M1; BARBETTE CARRIAGE M4

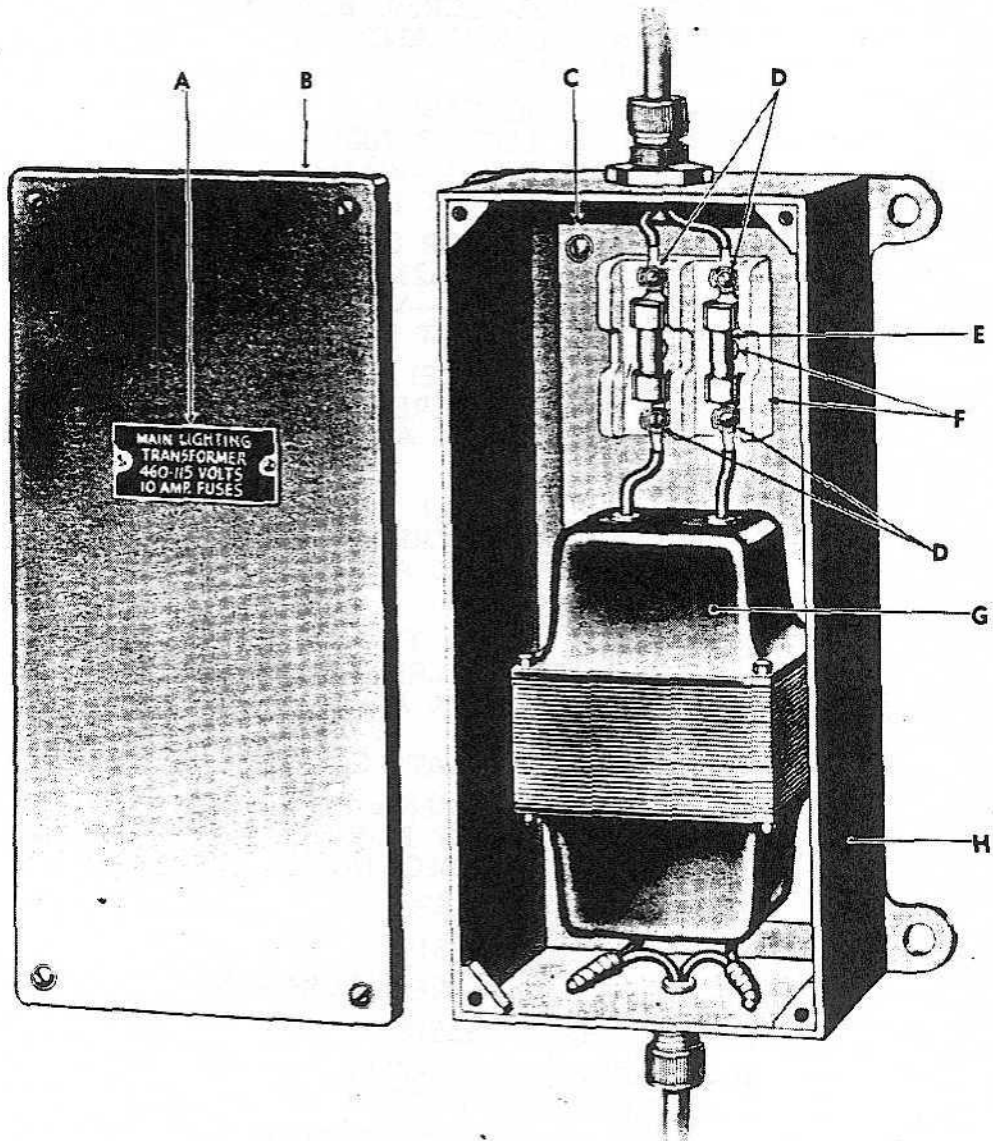

- A—PLATE (NAME) A217897 WITH SCREW BCOX1CB
- B—COVER (BOX) C87106 WITH SCREW BCNX4BE AND WASHER BEAX1G
- C—PLATE (INSULATION) B162588 WITH SCREW BCNX4CG AND WASHER BEAX1H
- D—TERMINAL A217823
- E—FUSE (CARTRIDGE) 10 AMP. A217899C

- F—CUT-OUT A217898 WITH SCREW BCNX4AG—WASHER BEAX1F AND NUT BBKX2G
- G—TRANSFORMER C87107 WITH SCREW BCNX4CG—NUT BBAX1A AND WASHER BEAX1H
- H—BOX D42348 WITH SCREW BCAX1EE—WASHER BECX1M AND NUT BBAX1E

RA PD 38834

Figure 153—Main Lighting Transformer (Assembly)

### ELECTRICAL EQUIPMENT

(1) **TRAVERSING MOTOR.** The traversing motor (D, fig. 154) is located on the upper surface of the outer platform at the left front of the carriage. It is a General Electric, totally enclosed  $7\frac{1}{2}$ -horsepower, 440-volt, 3-phase, 60-cycle, fan-cooled, gear-type motor designed for 629 revolutions per minute.

(a) A Waterbury hydraulic speed gear designed to control the speed and direction of movement of the rotating parts is attached to the motor by a special coupling.

(b) The electric traversing motor controller (A, fig. 154) is located under the outer platform at the left front of the carriage. It is a Westinghouse  $7\frac{1}{2}$ -horsepower, 440-volt, 10.15-amp, 3-phase, 60-cycle controller, equipped with a manual control lever for "ON," "OFF" and "RESET" operation.

(2) **ELEVATING MOTOR.** The elevating motor (W, fig. 151) is located on a platform under the inner platform on the right side of the carriage. It is a totally enclosed General Electric, 50-horsepower, 440-volt, 3-phase, fan-cooled, gear-type motor designed for 420 revolutions per minute.

(a) A Waterbury hydraulic speed gear, size 35, special, with right angle valve plate designed to control the speed and direction of elevation and depression of the gun and tipping parts, is attached to the motor by means of a special coupling.

(b) The electric elevating motor controller (J, fig. 151) is located under the inner platform on the right side of the carriage and to the right of the rammer controller. It is a 50-horsepower, 440-volt, 60.5-amp, 3-phase, 60-cycle controller equipped with a manual control lever for "ON," "OFF" and "RESET" operation.

(3) **RAMMER MOTOR.** The rammer motor (T, fig. 151) is located to the right of the rammer case and is attached to a motor base which in turn is bolted to the racer between the rear ends of the side frames. It is a totally enclosed 30-horsepower, 440-volt, 3-phase, 60-cycle, fan-cooled, gear-type motor designed for 561 revolutions per minute.

(a) A Waterbury hydraulic speed gear, size 10, with separable "A" and "B" end construction, designed to control the speed and direction of movement of the rammer head and chain, is attached to the motor. The "A" end (Q, fig. 110) is connected to the motor shaft by means of a special coupling. The "B" end (B, fig. 110) is connected to and controls the movement of the rammer parts.

(b) The electrical rammer motor controller (N, fig. 151) is located under the inner platform on the right side of the carriage to the left of the elevating motor controller. It is a 30-horsepower, 440-volt, 36.7-amp, 3-phase, 60-cycle controller equipped with a manual control lever for "ON," "OFF" and "RESET" operation.

(4) **AIR COMPRESSOR AND MOTOR CARRIAGES 19 TO 22.** The air compressor and motor unit for Carriages Nos. 19, 20, 21 and 22 (figs. 58 and 155) is located under the left inner platform.

**16-INCH SEACOAST GUN MATERIEL  
GUN MK. II M1; BARBETTE CARRIAGE M4**

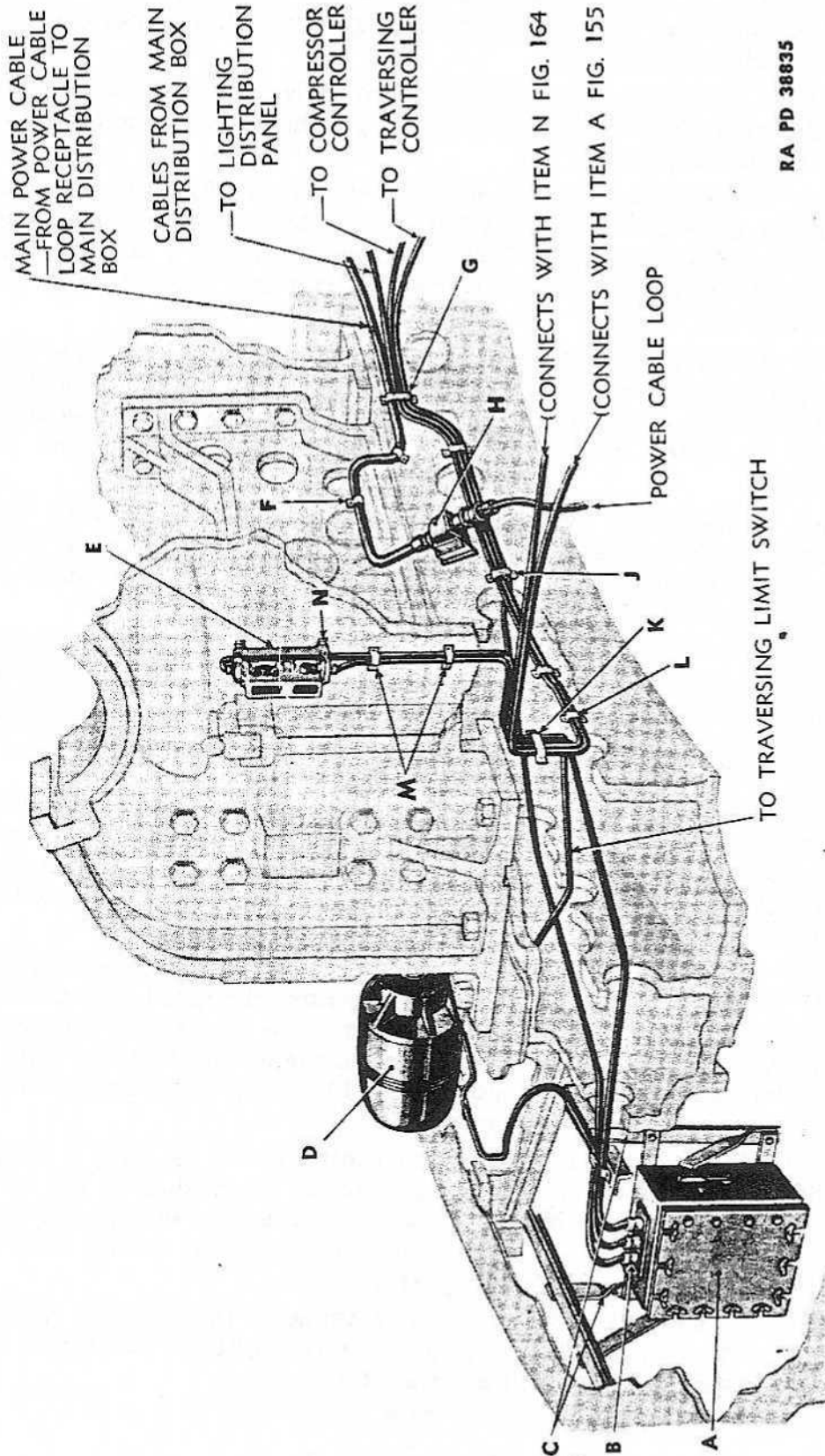

RA PD 38835

**Figure 154—Traversing Power Circuit and Front View of Cables**  
(LEGEND ON OPPOSITE PAGE)

ELECTRICAL EQUIPMENT

- G—CABLE CLAMP A217864 AND SCREW BCAX1BA
- H—POWER CABLE LOOP RECEPTACLE C54676
- J—CABLE CLAMP A217882 AND SCREW BCAX1BA
- K—CABLE CLAMP A217880 AND SCREW BCAX1BA
- L—CABLE CLAMP A217871 AND SCREW BCAX1BA
- M—CABLE CLAMP A217867 AND SCREW BCAX1BA
- N—TRAVERSING PUSH-BUTTON BRACKET A217861 WITH SCREW BCAX1CA

RA PD 38835A

- A—TRAVERSING CONTROLLER D49255 WITH SCREW BCAX1EE—WASHER BECX1M AND NUT BBAX1E
- B—CABLE CONNECTOR B162514
- C—CONTROLLER BRACKET B162556 AND B162557 WITH SCREW BCAX2BD—WASHER BECX1R AND NUT BBAX2C
- D—TRAVERSING MOTOR D42622 WITH SCREW BCAX1EL—NUT BBGX1E AND COTTER PIN BFAX1CR
- E—TRAVERSING PUSH-BUTTON STATION B162297 WITH SCREW BCNX2EM—WASHER BECX1K—NUT BBAX1C AND BUSHING CPHX1—1BQ
- F—CABLE CLAMP A217883 AND SCREW BCAX1BA

Legend for Figure 154—Traversing Power Circuit  
(ILLUSTRATION ON OPPOSITE PAGE)

**16-INCH SEACOAST GUN MATERIEL  
GUN MK. II M1; BARBETTE CARRIAGE M4**

(a) The motor is a totally enclosed type KF, 24-horsepower, 3-phase, 60-cycle, 440-volt, fan-cooled motor designed for 720 revolutions per minute with rotor mounted on the air compressor shaft.

(b) The compressor is a type 6/6 x 5 x 5-V3A2 unit directly connected to the motor.

(c) The motor and compressor unit is designed for the following conditions of service:

Speed 690 revolutions per minute.

Displacement 113 cubic feet per minute.

Actual capacity 88 cubic feet per minute free air.

Discharge pressure 150 pounds G.A.

Volumetric efficiency 77.9 percent.

Brake horsepower 24 brake horsepower.

Pressure setting 155 pounds cut-out, 135 pounds cut-in.

(5) AIR COMPRESSOR AND MOTOR CARRIAGES NO. 23 AND UP. The compressor and motor unit for Carriages No. 23 and up is located in the same position as for Carriages Nos. 19, 20, 21 and 22.

(a) The motor is 25-horsepower, 3-phase, 60-cycle, 440-volt, fan-cooled, 870 revolutions per minute. Connection of the motor and compressor is made by means of a special flexible coupling.

(b) The compressor is a type 5 $\frac{3}{8}$  x 4 $\frac{5}{8}$  x 5-V3A2 unit and differs from the compressors on Carriages Nos. 19, 20, 21 and 22 principally in the diameter of the pistons and cylinders and the fact that it is equipped with a direct-driven fan attached to the compressor shaft instead of a belt-driven fan as used on Carriages Nos. 19 to 22.

(c) The main difference in the conditions of service of the two complete motor and compressor units is in the speed of operation.

(d) It will be noted that there is no difference in the actual free air capacity of 88 cubic feet per minute, the cut-out pressure at 155 pounds, or the cut-in pressure at 135 pounds, per square inch, nor in the discharge pressure of 150 pounds.

(e) The electric motor and air compressor controller (A, fig. 155) for both types of air compressor motors is located on the left of the carriage. It is attached by a bracket to the left side frame and bolted to the left elevating gear plate. It is a Westinghouse 25-horsepower, 440-volt, 36.5 amp, 3-phase, 60-cycle controller equipped with a manual control lever for "ON," "OFF" and "RESET" operation.

(6) TRAVERSING LIMIT SWITCH DEVICE. To prevent power traverse of the mount beyond prescribed limits an electrical traversing limit switch (M, fig. 104) is attached to the lower end of the main traversing bracket at the front of the racer. (See Limits of Traverse, par. 9 j (2)).

(a) The switch is so designed that when traverse to the right or left of the center line of fire reaches 66 degrees, a wheel (R, fig. 104) attached to the switch comes in contact with rails (B, fig. 104) which are bolted to the base ring near the positions of extreme right and left traverse.

## ELECTRICAL EQUIPMENT

Pressure of the wheel against the rail deenergizes the motor and prevents further movement of the rotating mass by electrical power.

(7) **PUSH-BUTTON STATIONS.** For the purpose of controlling the various motors and other power appliances on the mount, push-button stations are provided at convenient locations on the carriage. These stations are operated from the working platform and are of sufficient height from the floor level to be easily accessible.

(a) The push-button station switches, limit switch, and pressure switch are so designed as to control only the current for the magnet of the controls. They do not carry the full motor current.

(8) **TRAVERSING PUSH-BUTTON STATION.** The push-button station for the traversing controller (E, fig. 154) and (fig. 156) is located on the left side of the mount near the slow-motion traversing and control handwheels. It contains push buttons for starting and stopping the traversing motor and in addition is provided with a button for controlling the limit switch device on the racer and base ring.

(9) **ELEVATING PUSH-BUTTON STATION.** The push-button station (fig. 157, and Q, fig. 151) for the elevating controller (J, fig. 151) is located on the right side of the carriage nearest and to the rear of the elevating handwheel. It is provided with "START" and "STOP" push buttons for starting and stopping the elevating motor.

(10) **RAMMER PUSH-BUTTON STATION.** The push-button station (fig. 157, and R, fig. 151) for the rammer controller (N, fig. 151) is identical with the push-button station for the elevating controller. It is located on the right side of the carriage, near and to the rear of the elevating push-button station. It is provided with "START" and "STOP" buttons for starting and stopping the rammer motor.

(11) **AIR COMPRESSOR PUSH-BUTTON STATION.** The push-button station (fig. 158, and B, fig. 155) for the air compressor and motor controller (A, fig. 155) is located on the left side of the carriage, near and to the rear of the air compressor controller. It is provided with "START" and "STOP" buttons for starting and stopping the air compressor motor. It is also provided with two control buttons for establishing continuous or intermittent operation of the air compressor.

(a) The air compressing device is equipped with a pressure switch and magnetic unloader (fig. 61) which operates in accordance with the setting of the buttons in the push-button station. When push button is set at "CONTINUOUS" the air compressor unit will operate continuously supplying air to the compressed air tanks as required to maintain pressure between the limits of 135 and 155 pounds per square inch. When pressure of 155 pounds is established under "CONTINUOUS" operation the motor continues to operate but the air is bypassed through the compressor, thereby avoiding danger of excess pressure in the air compressor unit.

(b) When the push button is set at "AUTOMATIC" the motor will operate only to establish maximum pressure of 155 pounds per square



**16-INCH SEACOAST GUN MATERIEL  
GUN MK. II M1; BARBETTE CARRIAGE M4**

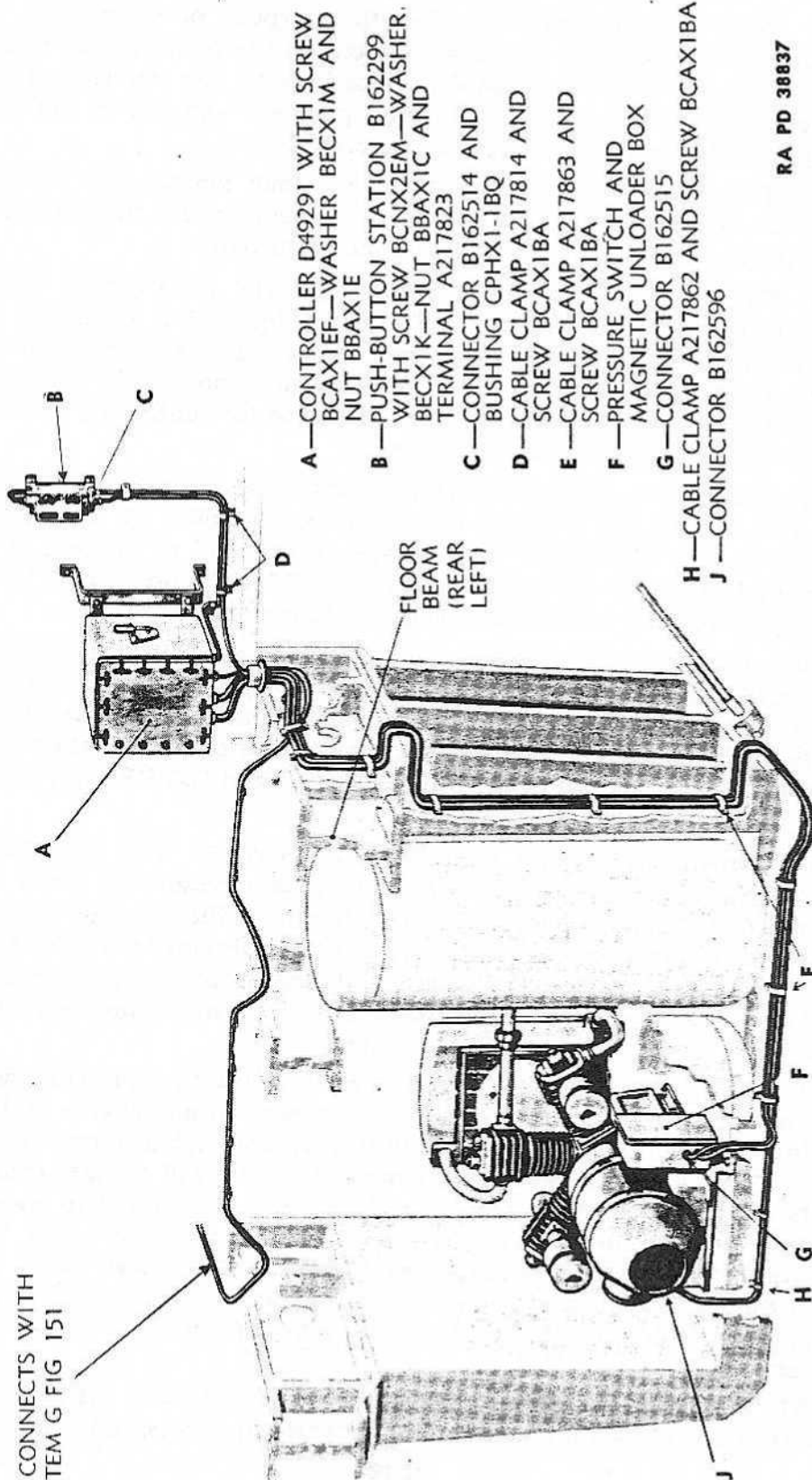

RA PD 38837

**Figure 155—Air Compressor Power Circuit**

### ELECTRICAL EQUIPMENT

inch. When this pressure is reached the pressure switch (fig. 61) operates to stop the motor which will be reenergized when the pressure drops to 135 pounds per square inch. The motor will continue to operate until the maximum pressure of 155 pounds is again attained, thus insuring air pressure between the limits of 135 and 155 pounds per square inch at all times.

#### (12) POWER CABLES.

(a) The cable loop (fig. 149) leading from the receptacle on the emplacement (E, fig. 150) to an identical receptacle on the racer carries current for both power and lighting. It consists of three conductors each made up of 259 strands of No. 1/0 tinned copper wire conductor, enclosed in a protective casing having an outside diameter of 1.70 inches. The total voltage capacity of the cable is 600 volts.

(b) The cable leading from the receptacle on the racer (E, fig. 150) to the main distribution box (G, fig. 151) and (fig. 152) carries current

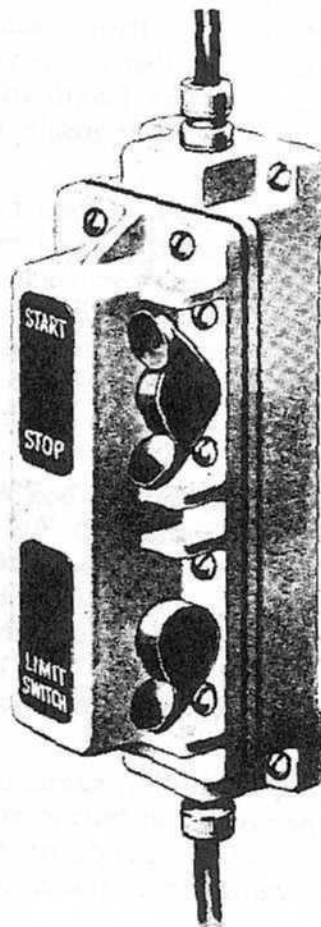

Figure 156—Push-button Station for Traversing Controller

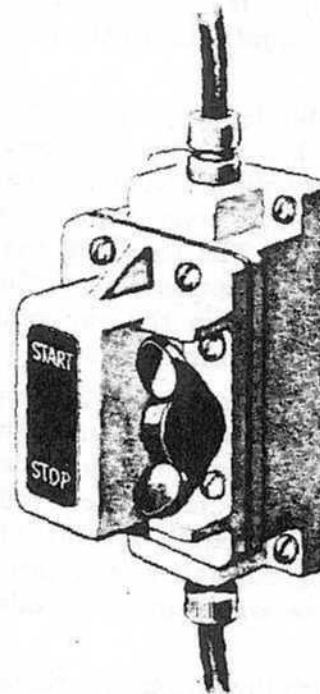

Figure 157—Push-button Station for Elevating and Rammer Controllers

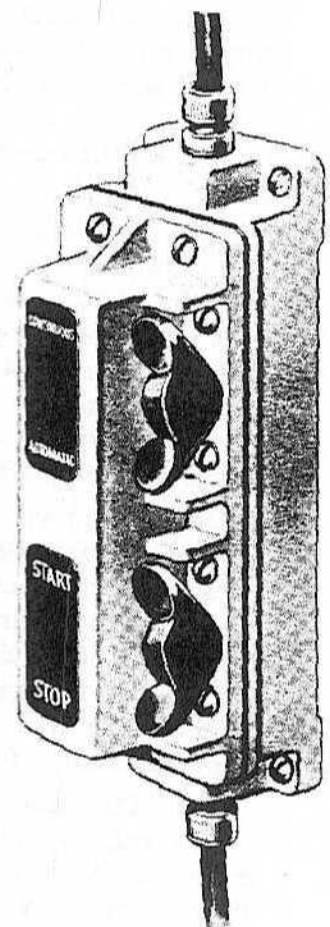

Figure 158—Push-button Station for Air Compressor Controller

RA PD 38838

**16-INCH SEACOAST GUN MATERIEL  
GUN MK. II M1; BARBETTE CARRIAGE M4**

for power and lighting. It consists of three conductors each made up of 61 strands of No. 1/0 tinned copper wire conductor, coded red, white, and black. The outside diameter of the cable is 1.67 inches. The total length required is approximately 19 feet.

(c) The power cable leading from the main distribution box to the elevating controller (J, fig. 151) and elevating motor (W, fig. 151) consists of three conductors each made up of seven strands of No. 4 tinned copper wire conductor, coded red, white, and black. The outside diameter of the cable is 1.185 inches. The length of the cable from the main distribution box to the elevating controller is approximately 18 feet. The length of the cable from the elevating controller to the elevating motor is approximately 16 feet.

(d) The power cable leading from the main distribution box to the rammer controller (N, fig. 151) and rammer motor (T, fig. 151) consists of three conductors each made up of seven strands of No. 6 tinned copper wire conductor, coded red, white, and black. Outside diameter is 0.967 inch. The length of the cable from the main distribution box to the rammer controller is approximately 12 feet. The length of the cable from the rammer controller to the rammer motor is approximately 32 feet.

(e) The power cable leading from the main distribution box to the air compressor controller (A, fig. 155) and air compressor and motor unit (fig. 58) consists of three conductors each made up of seven strands of No. 8 tinned copper wire conductor, coded red, white, and black, outside diameter 0.884 inch. The length of the cable from the main distribution box to the air compressor controller is approximately 45 feet. The length of the cable from the air compressor controller to the air compressor motor is approximately 28 feet.

(f) The power cable leading from the main distribution box to the traversing controller (A, fig. 154) and traversing motor (D, fig. 154) consists of three conductors each made up of seven strands of No. 14 tinned copper wire conductor, coded red, white, and black, outside diameter 0.560 inch. The length of the cable from the main distribution box to the traversing controller is approximately 30 feet. The length of the cable from the traversing controller to the traversing motor is approximately 9 feet.

(g) The cables leading from the elevating controller, rammer controller and traversing controller to their respective push-button stations consist of three conductors each made up of seven strands of No. 14 tinned copper wire conductor, coded red, white, and black, outside diameter 0.560 inch.

(h) The length of the cable from the elevating controller to the elevating push-button station is approximately 21 feet. From the rammer controller to the rammer push-button station is approximately 24 feet. From the traversing controller to the traversing push-button station is approximately 15 feet.

**ELECTRICAL EQUIPMENT**

(i) The cable leading from the air compressor controller to the air compressor push-button station and from the air compressor push-button station to the pressure switch and magnetic unloader, also from the traversing push-button station to the traversing limit switch consists of two conductors each made up of seven strands of No. 14 tinned copper wire conductor, coded white and black, outside diameter 0.530 inch. The length of cable from the air compressor controller to the air compressor push-button station is approximately 9 feet; from the air compressor push-button station to the pressure switch and magnetic unloader is approximately 24 feet; from the traversing push-button station to the traversing limit switch is approximately 17 feet.

(j) The cable leading from the air compressor controller to the pressure switch and magnetic unloader consists of a single conductor, seven strands No. 14 tinned copper wire conductor, outside diameter 0.248 inch, length approximately 20 feet.

**31. OPERATION OF POWER EQUIPMENT.**

**a. Procedure.**

(1) Check at *all* push-button stations to insure that the switches are open by testing the spring return action of the switches at start and stop positions.

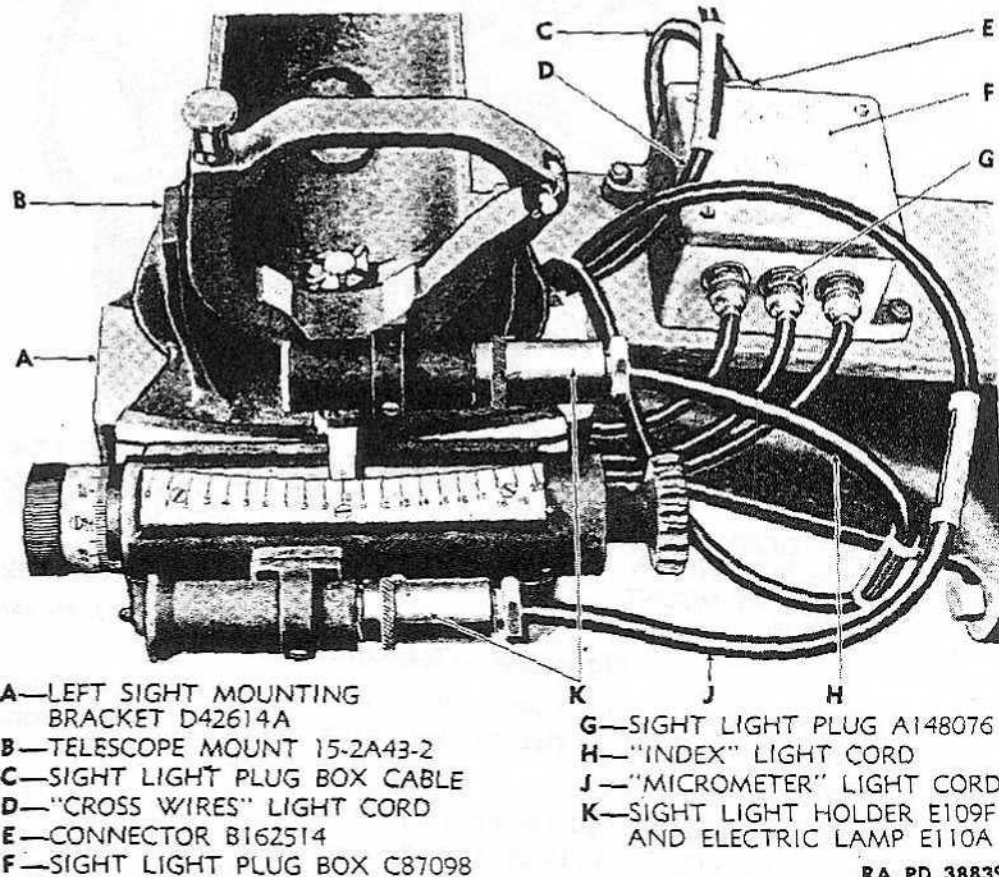

- A—LEFT SIGHT MOUNTING BRACKET D42614A
- B—TELESCOPE MOUNT 15-2A43-2
- C—SIGHT LIGHT PLUG BOX CABLE
- D—"CROSS WIRES" LIGHT CORD
- E—CONNECTOR B162514
- F—SIGHT LIGHT PLUG BOX C87098

- G—SIGHT LIGHT PLUG A148076
- H—"INDEX" LIGHT CORD
- J—"MICROMETER" LIGHT CORD
- K—SIGHT LIGHT HOLDER E109F AND ELECTRIC LAMP E110A

RA PD 38839

**Figure 159—Sight Lighting Equipment**

**16-INCH SEACOAST GUN MATERIEL  
GUN MK. II M1; BARBETTE CARRIAGE M4**

(2) Note that the handles on all motor controllers are at "OFF" position, that the traversing indicator dials are at zero position on the traversing control gear case, and that the rammer control lever is in neutral position.

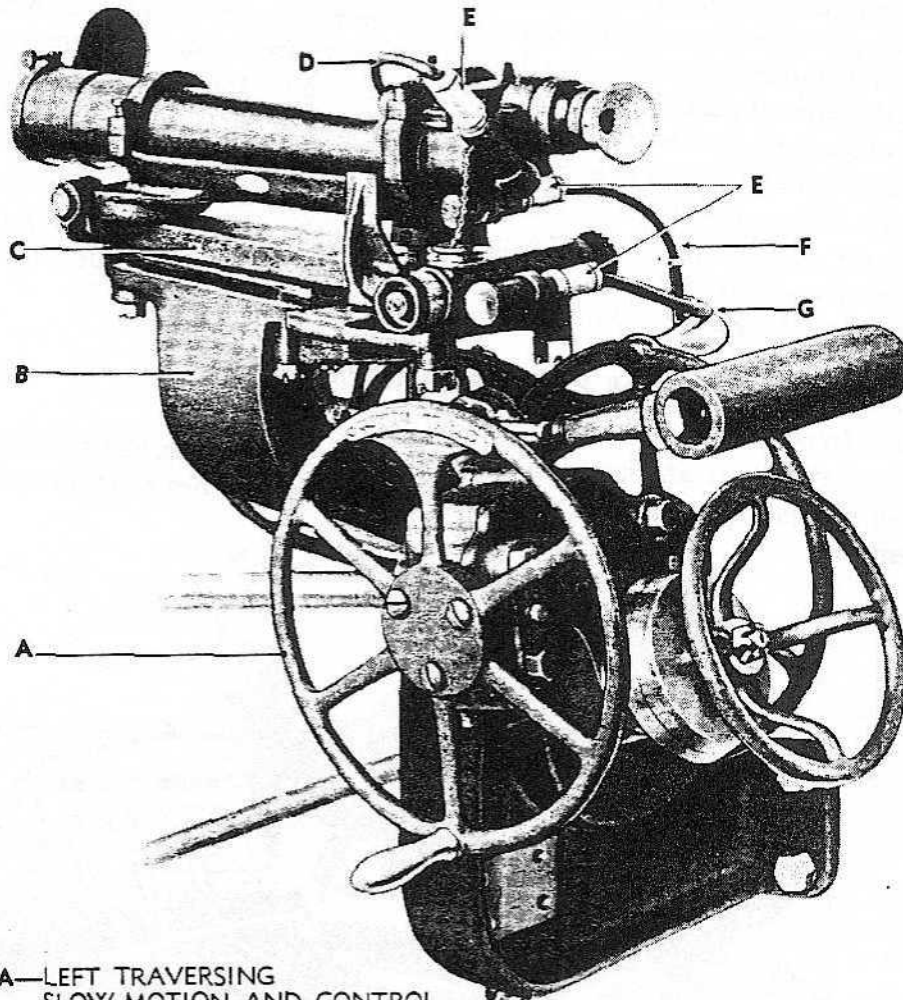

A—LEFT TRAVERSING  
SLOW-MOTION AND CONTROL  
HANDWHEELS

B—LEFT SIGHT MOUNTING  
BRACKET D42614A

C—TELESCOPE MOUNT  
15-2A43-2

D—"CROSS WIRES" LIGHT CORD

E—SIGHT LIGHT HOLDER E109F  
AND ELECTRIC LAMP E110A

F—"INDEX" LIGHT CORD

G—"MICROMETER" LIGHT CORD

RA PD 38840

**Figure 160—Telescope Mount**

(3) Connect the cable loop (H, fig. 149) to the receptacles (A, fig. 149, and E, fig. 150) in the emplacement well and on the front racer segment.

(4) TRAVERSING MOTOR AND LIMIT SWITCH. To operate the traversing motor (D, fig. 154) set the traversing control handwheel (T, fig. 94) at zero on the traversing control indicator dial (Q, fig. 93) at the left slow-motion traversing handwheel (J, fig. 93) or at the azimuth

**ELECTRICAL EQUIPMENT**

- A—LEFT SIDE FRAME D42550A
- B—THREE CABLE CLAMP A217815 AND SCREW BCAX1BA
- C—FOUR CABLE CLAMP A217816 AND SCREW BCAX1BA
- D—SIGHT LIGHTING TRANSFORMER ASSEMBLY D42353B
- E—CONNECTOR B162514
- F—SCREW BCAX1CC
- G—SINGLE CABLE CLAMP A217813 AND SCREW BCAX1BA
- H—LIGHTING DISTRIBUTION PANEL ASSEMBLY D42347
- J—SCREW BCAX1EF AND WASHER BEBX2F
- K—RUBBER COVERED LIGHTING CABLE
- L—CONDULET B127998 AND SCREW BCAX1BD
- M—PORTABLE LAMP RECEPTACLE HOUSING B128000 AND SCREW BCNX4BE
- N—3-WAY JUNCTION BOX B162524 AND SCREW BCAX1BD
- P—AZIMUTH OBSERVERS CAB LIGHT SWITCH BOX B162528 AND SCREW BCAX1BD
- Q—TWO CABLE CLAMP A217814 AND SCREW BCAX1BA
- R—LEFT ELEVATING GEAR PLATE D42606

RA PD 38841

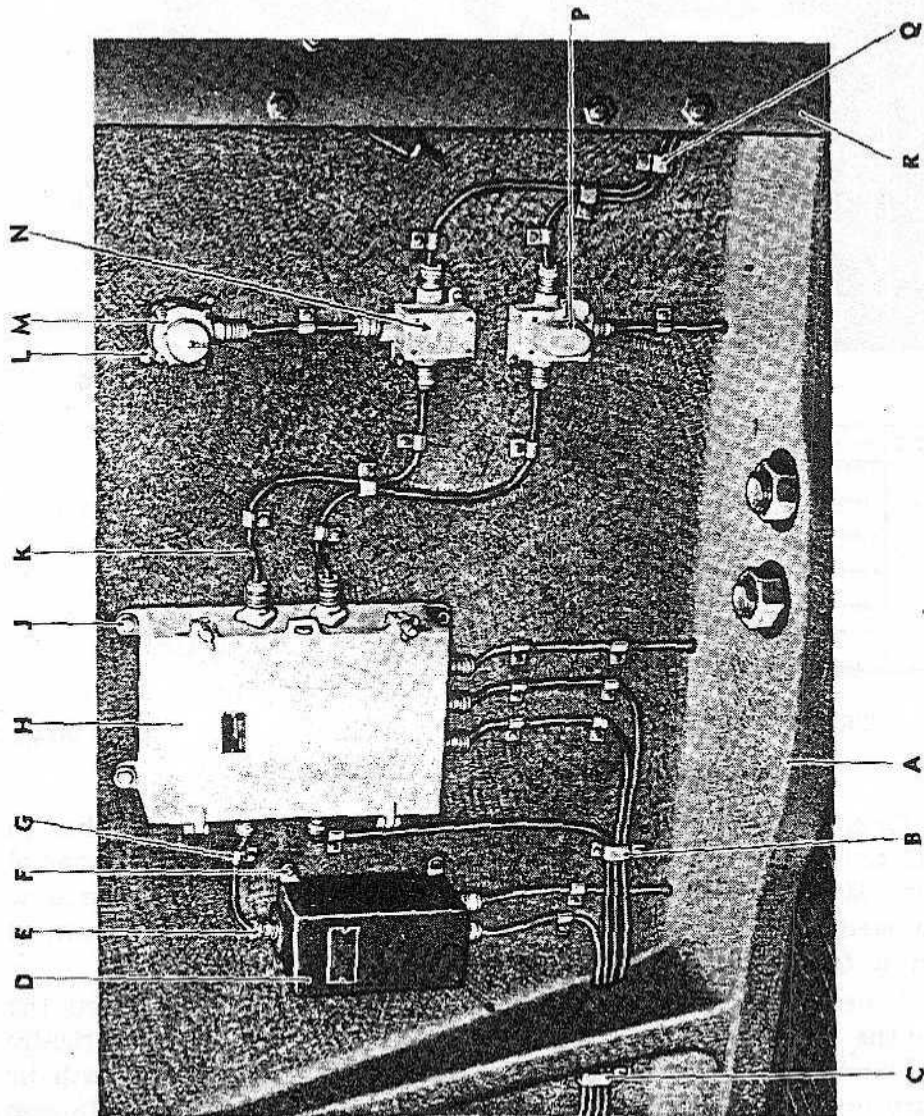

**Figure 161—Sight Lighting Transformer—Distribution Panel—Plug—Junction and Switch Boxes**

**16-INCH SEACOAST GUN MATERIEL  
GUN MK. II M1; BARBETTE CARRIAGE M4**

observer's cab (D, fig. 103). These two units are complementary and cannot be operated independently.

(a) Set the traversing shift lever (N, fig. 94) at "POWER" position using slow-motion handwheel, if necessary, to bring clutch gearing into alinement.

(b) Press "START" button in the traversing push-button station (E, fig. 154).

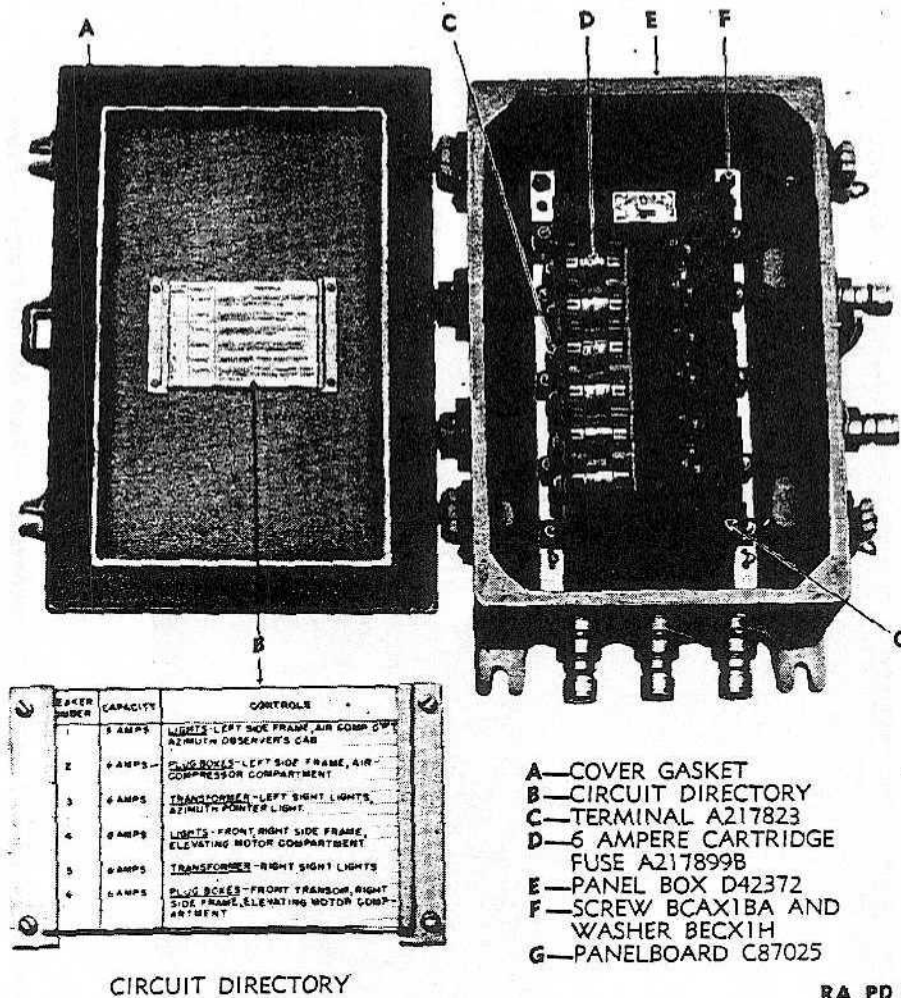

CIRCUIT DIRECTORY

RA PD 38842

**Figure 162—Lighting Distribution Panel**

(c) Operate the control handwheel to traverse the mount either to the right or left as indicated by direction arrows on the traversing control gear case. When approaching limits of traverse in either direction slow down movement of the rotating mass by means of the traversing control handwheel. (See Limits of Traverse, par. 9 j (2)).

(d) When the wheel on the limit switch (M, fig. 104) contacts the rail on the base ring (B, fig. 104) the power will be automatically shut off and the motor will stop. To again start the motor it will be necessary to press the limit switch button in the traversing push-button

## ELECTRICAL EQUIPMENT

station; and the button must be *held* in this position until the wheel on the limit switch arm clears the rail on the base ring. Pressing the limit switch button will *not* energize the motor. The "START" button must be pressed to start the motor.

(e) The power may be shut off at any time by pressing the "STOP" button in the traversing push-button station.

(5) ELEVATING MOTOR. To start the elevating motor (W, fig. 151) press the "START" button in the elevating push-button station (Q, fig. 151). Starting the motor will not activate the tipping parts until the elevating follow-up control handwheel (H, fig. 71) is manipulated.

(a) The direction of movement of the tipping parts is determined by turning the control handwheel either clockwise or counterclockwise as indicated by direction arrows on the control handwheel.

(b) The limits of elevation and depression are controlled by means of control cams (H, fig. 72, and X, fig. 87) on the elevating racks. Before reaching the extreme limits of elevation or depression these cams automatically disengage the train of gearing from the elevating motor, thus avoiding undue shock to the moving parts.

(c) To deenergize the motor press the stop button in the elevating push-button station.

(6) RAMMER MOTOR. Before starting the rammer motor (T, fig. 151) place the control lever (Q, fig. 109) in neutral position in the lever detent (M, fig. 109). Start the rammer motor by pressing the "START" button in the rammer push-button station (R, fig. 151).

(a) To operate the rammer by power, the clutch lever handle (S, fig. 109) on the left side of the case must be pinned in the outer hole of the lever locking device.

(b) Starting the motor will not activate the rammer head and chain (fig. 146) so long as the control lever remains in neutral position. To activate the rammer head and chain the control lever must be raised or lowered from the detent groove.

(c) To stop the motor press the "STOP" button in the push-button station.

(7) AIR COMPRESSOR MOTOR. To operate the air compressor motor unit (figs. 58 and 155) when the piece is to be put into operation, press the push button marked "CONTINUOUS" at the air compressor push-button station (B, fig. 155). If the piece is to be kept at "ALERT" press the button marked "AUTOMATIC."

(a) When the "CONTINUOUS" button is pressed the motor will operate without interruption. Under this condition, when pressure in the air line reaches 155 pounds per square inch the air will be bypassed through the compressor into the outer atmosphere, thus eliminating danger of injury to the cylinders and air pipe line.

(b) When the "AUTOMATIC" button is pressed the motor will operate only so long as the pressure is under 155 pounds per square inch. When this pressure is attained the motor stops automatically and



**16-INCH SEACOAST GUN MATERIEL  
GUN MK. II M1; BARBETTE CARRIAGE M4**

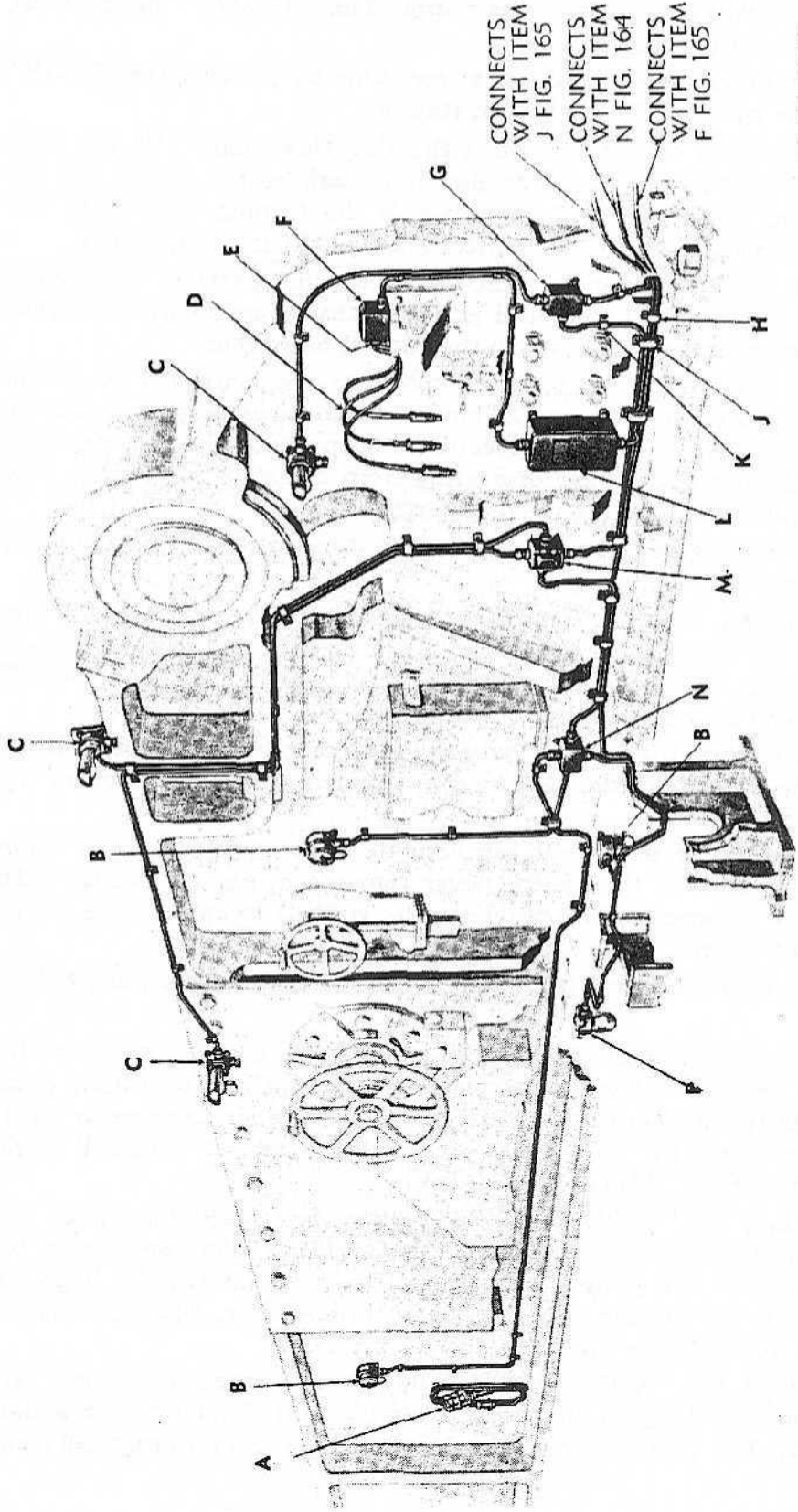

CONNECTS WITH ITEM  
J FIG. 165

CONNECTS WITH ITEM  
N FIG. 164

CONNECTS WITH ITEM  
F FIG. 165

RA PD 38843

**Figure 163—Lighting Circuits (Right Side)**  
(LEGEND ON OPPOSITE PAGE)

ELECTRICAL EQUIPMENT

- K—(1-CABLE) CLAMP A217813  
NOTE: ALL CLAMPS WITH  
SCREW BCAX1BA
- L—(RIGHT)SIGHT LIGHTING  
TRANSFORMER (ASSEMBLY)  
D42353A
- M—(ELEVATING MOTOR COM-  
PARTMENT LAMP) SWITCH  
BOX (4-WAY) B162527
- N—JUNCTION BOX (4-WAY)  
B162523
- P—LAMP RECEPTACLE BOX  
B162530 AND LAMP E13AN  
NOTE: ALL CONNECTORS B162514  
ALL TERMINALS A217823.

RA PD 38843A

- A—HAND LAMP (ASSEMBLY)  
C87250
- B—HAND LAMP PLUG RECEPTACLE  
HOUSING B128000  
CONDULET B127998
- C—LAMP RECEPTACLE BOX  
B162529—LAMP E13AN
- D—(SIGHT LIGHT)—2-CONDUCTOR  
FLEXIBLE CORD
- E—PLUG A148076
- F—(SIGHT LIGHT)PLUG BOX  
C87098
- G—JUNCTION BOX (3-WAY)  
B162525
- H—(2-CABLE) CLAMP A217814
- J—(3-CABLE) CLAMP A217815

Legend for Figure 163—Lighting Circuits (Right Side)  
(ILLUSTRATION ON OPPOSITE PAGE)

16-INCH SEACOAST GUN MATERIEL  
GUN MK. II M1; BARBETTE CARRIAGE M4

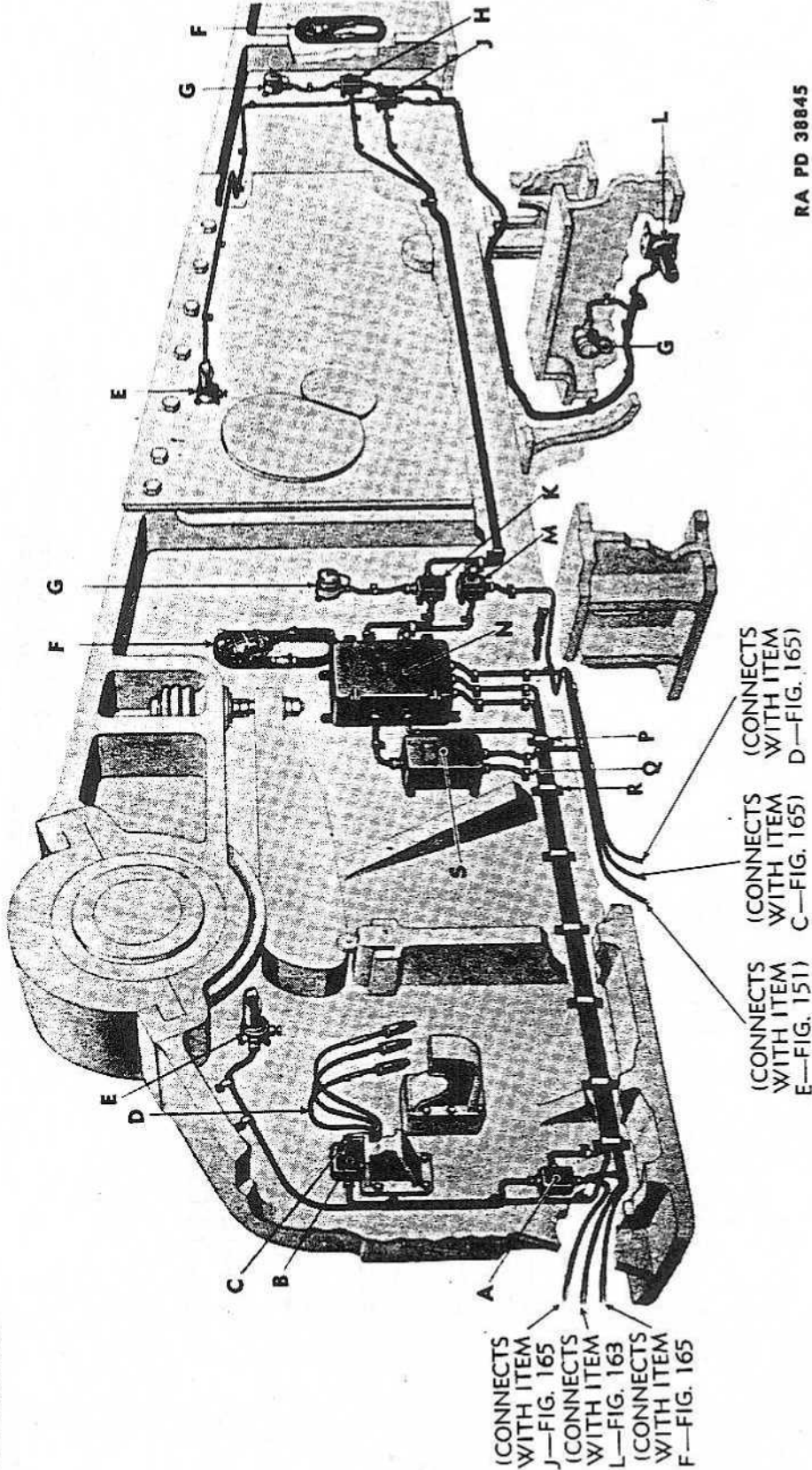

(CONNECTS WITH ITEM WITH FIG. 165 J—FIG. 165)  
(CONNECTS WITH ITEM WITH FIG. 163 L—FIG. 163)  
(CONNECTS WITH ITEM WITH FIG. 165 F—FIG. 165)

(CONNECTS WITH ITEM WITH FIG. 151) E—FIG. 151)

(CONNECTS WITH ITEM WITH FIG. 165) C—FIG. 165)

(CONNECTS WITH ITEM WITH FIG. 165) D—FIG. 165)

RA PD 38845

Figure 164—Lighting Circuits (Left Side)  
(LEGEND ON OPPOSITE PAGE)

**ELECTRICAL EQUIPMENT**

- A**—JUNCTION BOX (3-WAY)  
B162525
  - B**—(SIGHT LIGHT) PLUG BOX  
C87098
  - C**—(SIGHT LIGHT CORD) PLUG  
A148076
  - D**—(SIGHT LIGHT) 2-CONDUCTOR  
FLEXIBLE CORD
  - E**—LAMP RECEPTACLE BOX  
B162529 AND LAMP E13AN
  - F**—HAND LAMP (ASSEMBLY)  
C87250
  - G**—HAND LAMP PLUG RECEPTACLE  
HOUSING B128000 WITH  
CONDULET B127998
  - H**—(4-WAY) JUNCTION BOX B162523
  - J**—(COMPRESSOR COMPARTMENT  
LAMP) SWITCH BOX B162526
  - K**—JUNCTION BOX (3-WAY) B162524
  - L**—LAMP RECEPTACLE BOX  
B162530 AND LAMP E13AN
  - M**—(AZIMUTH OBSERVER'S CAB  
LAMP) SWITCH BOX (3-WAY)  
B162528
  - N**—LIGHTING DISTRIBUTION  
PANEL D42347
  - P**—(3-CABLE) CLAMP A217815
  - Q**—(1-CABLE) CLAMP A217813
  - R**—(4-CABLE) CLAMP A217816  
NOTE: ALL CLAMPS WITH  
SCREW BCAX1BA
  - S**—(LEFT) SIGHT LIGHTING  
TRANSFORMER (ASSEMBLY)  
D42353B
- NOTE: ALL CONNECTORS—B162514  
ALL TERMINALS—A217823

RA PD 38845A

**Legend for Figure 164—Lighting Circuits (Left Side)**  
(ILLUSTRATION ON OPPOSITE PAGE)

**16-INCH SEACOAST GUN MATERIEL  
GUN MK. II M1; BARBETTE CARRIAGE M4**

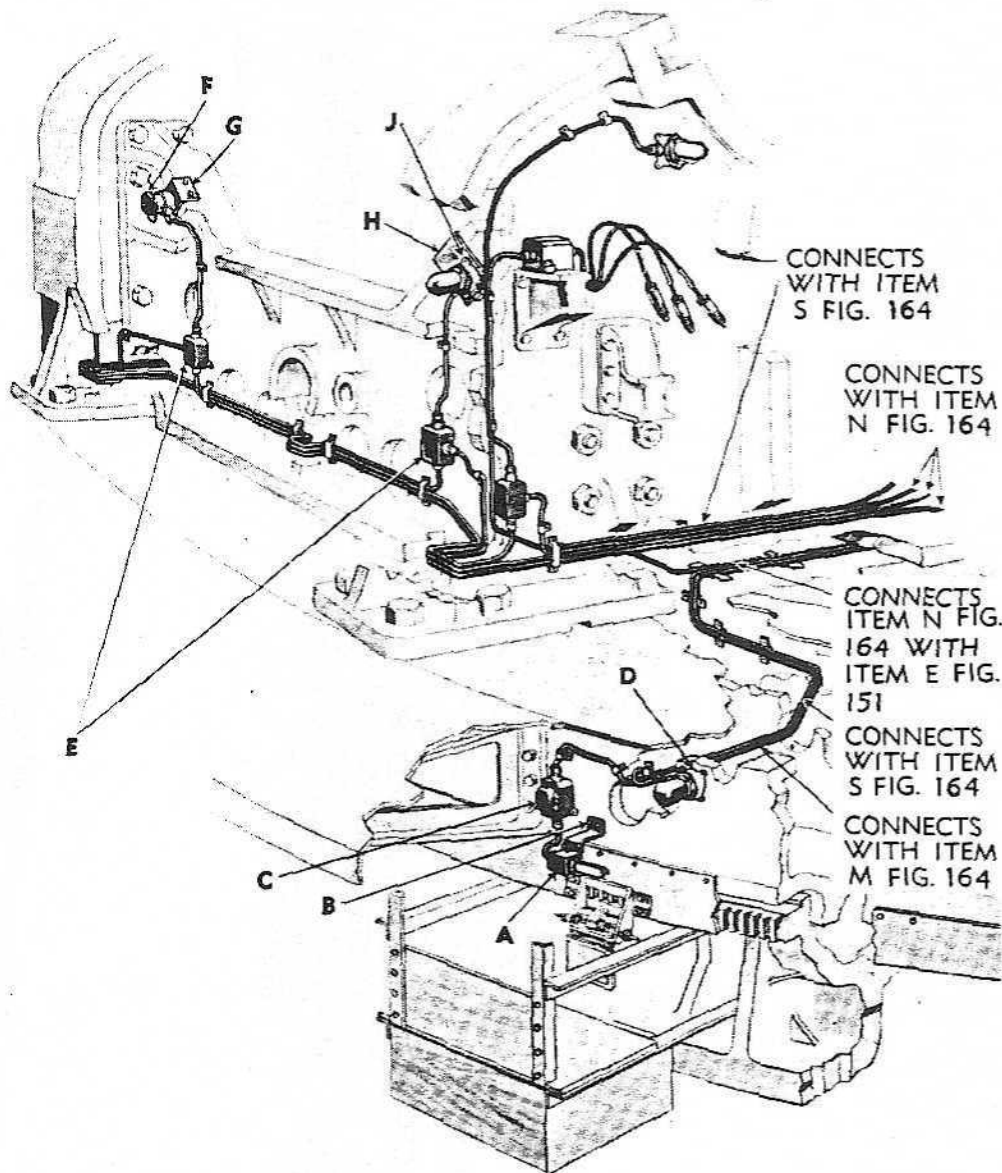

**A**—(AZIMUTH OBSERVER'S CAB INDICATOR) LAMP JUNCTION BOX E107M—COUPLING E27W—REFLECTOR E9M AND LAMP E110C

**B**—(AZIMUTH OBSERVER'S CAB INDICATOR) LAMP JUNCTION BOX BRACKET E117F WITH SCREW BCAX1EC

**C**—(AZIMUTH OBSERVER'S CAB INDICATOR LAMP) SWITCH BOX B162527

**D**—LAMP RECEPTACLE BOX B162530 AND LAMP E13AN

**E**—JUNCTION BOX (3-WAY) B162525

**F**—HAND LAMP PLUG RECEPTACLE HOUSING B128000 WITH CONDULET B127998

**G**—PLUG BOX BRACKET B187372 WITH SCREW BCAX1CC

**H**—LAMP RECEPTACLE BOX BRACKET B162531 AND SCREW BCAX1CC

**J**—LAMP RECEPTACLE BOX B162529 AND LAMP E13AN

RA PD 38847

**Figure 165—Lighting Circuits—Front Transom Azimuth Observer's Cab**

### ELECTRICAL EQUIPMENT

will be reenergized only when the pressure in the air line is reduced to 135 pounds per square inch, thus insuring a continuous pressure within the limits of 135 and 155 pounds.

(c) The pressure switch and magnetic unloader (fig. 61) connected to the motor and compressor unit work automatically and require no hand manipulation during the operation of this unit.

(d) To stop the air compressor motor press the button marked "STOP" in the air compressor and motor push-button station.

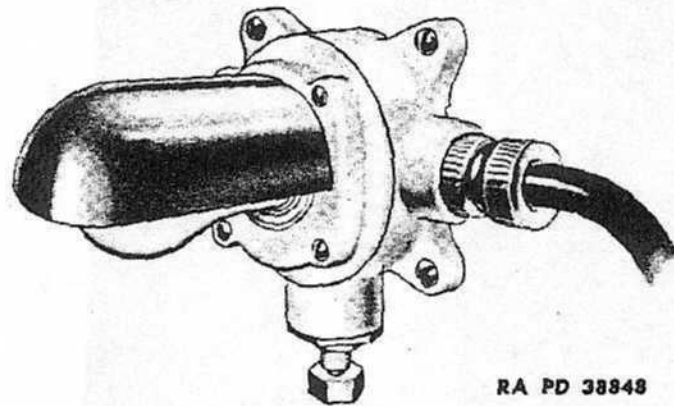
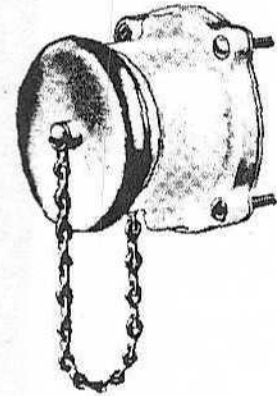

Figure 166—Lamp Receptacle,  
Assembly



RA PD 38848

Figure 166-1—Plug Receptacle,  
Assembly

(8) All motors on the carriage excepting the air compressor motor are equipped with Waterbury speed gears.

(a) The speed and direction of the traversing motor, elevating motor and rammer motor is controlled by means of hand-operated devices activating the speed gears.

(b) The operation of the air compressor motor is controlled by the pressure in the air compressor tanks and air pipe line, operating between the limits of atmospheric pressure and pressure of 155 pounds per square inch.

#### (9) MOTOR CONTROLLERS.

(a) All motors on the mount are equipped with Westinghouse motor controllers (J and N, fig. 151, A, fig. 154, and A, fig. 155). These controllers are designed to start and stop the motors.

(b) A built-in circuit breaker provides a means for breaking the electric circuit to the motor in the event of a short circuit in the power line. When a short circuit occurs the manual lever on the controller will nevertheless remain in the "ON" position although the motor will be deenergized. To reestablish the circuit it will be necessary to disengage the manual lever from the "ON" position and move it counterclockwise to the "OFF," "RESET" position. This action causes the manual lever to pick up the circuit breaker yoke which will be reset when the manual lever is returned to the "ON" position.

(c) In the event of failure of the motor to operate when the start button is pressed it may indicate a short circuit in the power line and

**16-INCH SEACOAST GUN MATERIEL  
GUN MK. II M1; BARBETTE CARRIAGE M4**

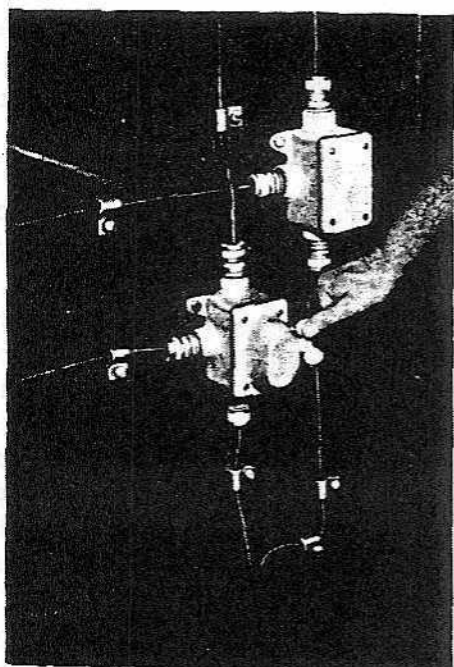
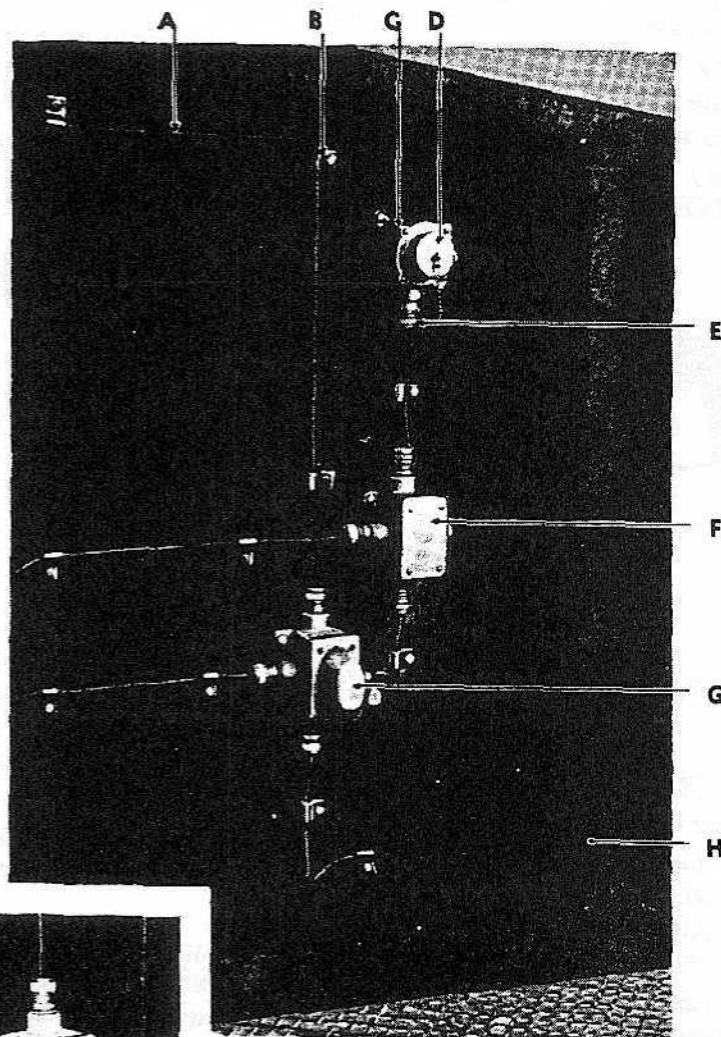

- A—RUBBER COVERED LIGHTING CABLE
- B—SINGLE CABLE CLAMP A217813 AND SCREW BCAX1BA
- C—CONDULET B127998 AND SCREW BCAX1BD
- D—PORTABLE LAMP RECEPTACLE HOUSING B128000 AND SCREW BCNX4BE
- E—CONNECTOR B162514
- F—FOUR-WAY JUNCTION BOX B162523 PIPE PLUG CPMX1BE AND SCREW BCAX1BD
- G—COMPRESSOR COMPARTMENT LIGHT SWITCH BOX B162526 AND SCREW BCAX1BD
- H—LEFT SIDE FRAME D42550A

RA PD 38849

**Figure 167—Compressor Compartment Light Switch—Four-way Connector Box and Portable Light Receptacle**

**ELECTRICAL EQUIPMENT**

the procedure above outlined to reenergize the motor will be followed. If the motor fails to operate after the action above outlined is taken, or if there is a recurrence of the trouble, the matter will be brought to the attention of the ordnance personnel for correction.

(d) All motors on the mount are designed with factors of safety sufficient to care for any anticipated overload that may occur; however, when the piece is in operation, observation of the motors should be made at frequent intervals to insure that there is no overheating of the motors which might occur in the event of excessive friction or other malfunctions of the gun and carriage. If overheating is indicated, the matter should be called to the attention of the ordnance personnel.

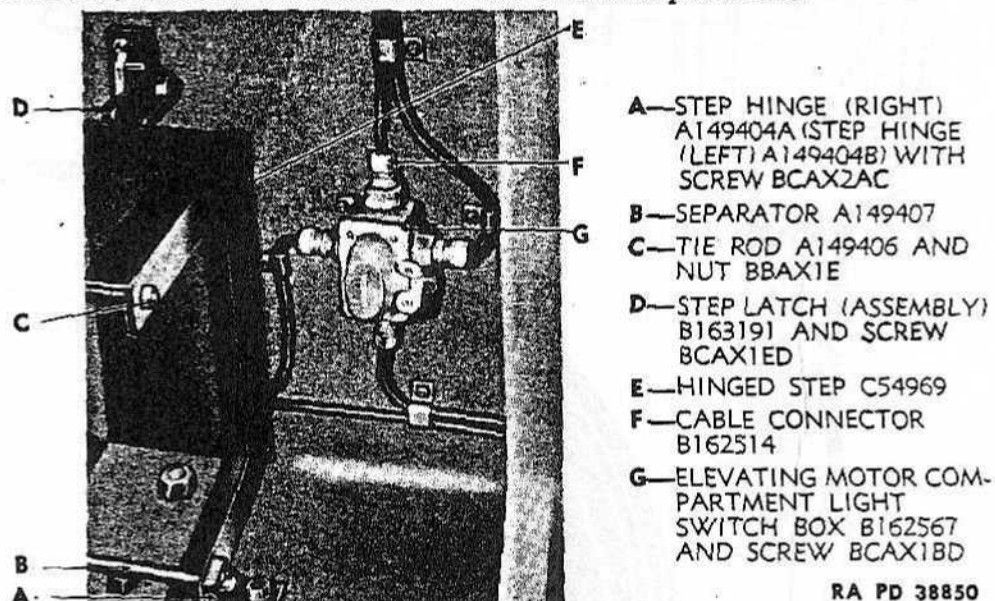

**Figure 168—Hinged Step and Elevating Motor Compartment Light Switch**

(10) PUSH-BUTTON STATIONS. Push-button stations are designed to provide a convenient means for starting and stopping the various motors on the carriage. Pressing the switch buttons results in making or breaking the circuits leading from the main distribution box to the motors through the motor controllers. The push-button stations for traversing, elevating and rammer control are of the return type and are not provided with latches for holding the push buttons in "ON" or "OFF" position. The air compressor push-button station is provided with a latch type of button for both "CONTINUOUS" and "AUTOMATIC" service. When operated, either of these buttons will remain in contact until released by pressure on the "STOP" button.

**32. DESCRIPTION AND FUNCTIONING OF LIGHTING EQUIPMENT.**

a. Current for lighting is delivered to the main distribution box (G, fig. 151) and (fig. 152) through the power feeder cable loop and three-conductor cable leading from the receptacle on the racer, as described in paragraph 30 a (12) (g) under "Power Cables."



TM 9-471  
32

**16-INCH SEACOAST GUN MATERIEL  
GUN MK. II M1; BARBETTE CARRIAGE M4**

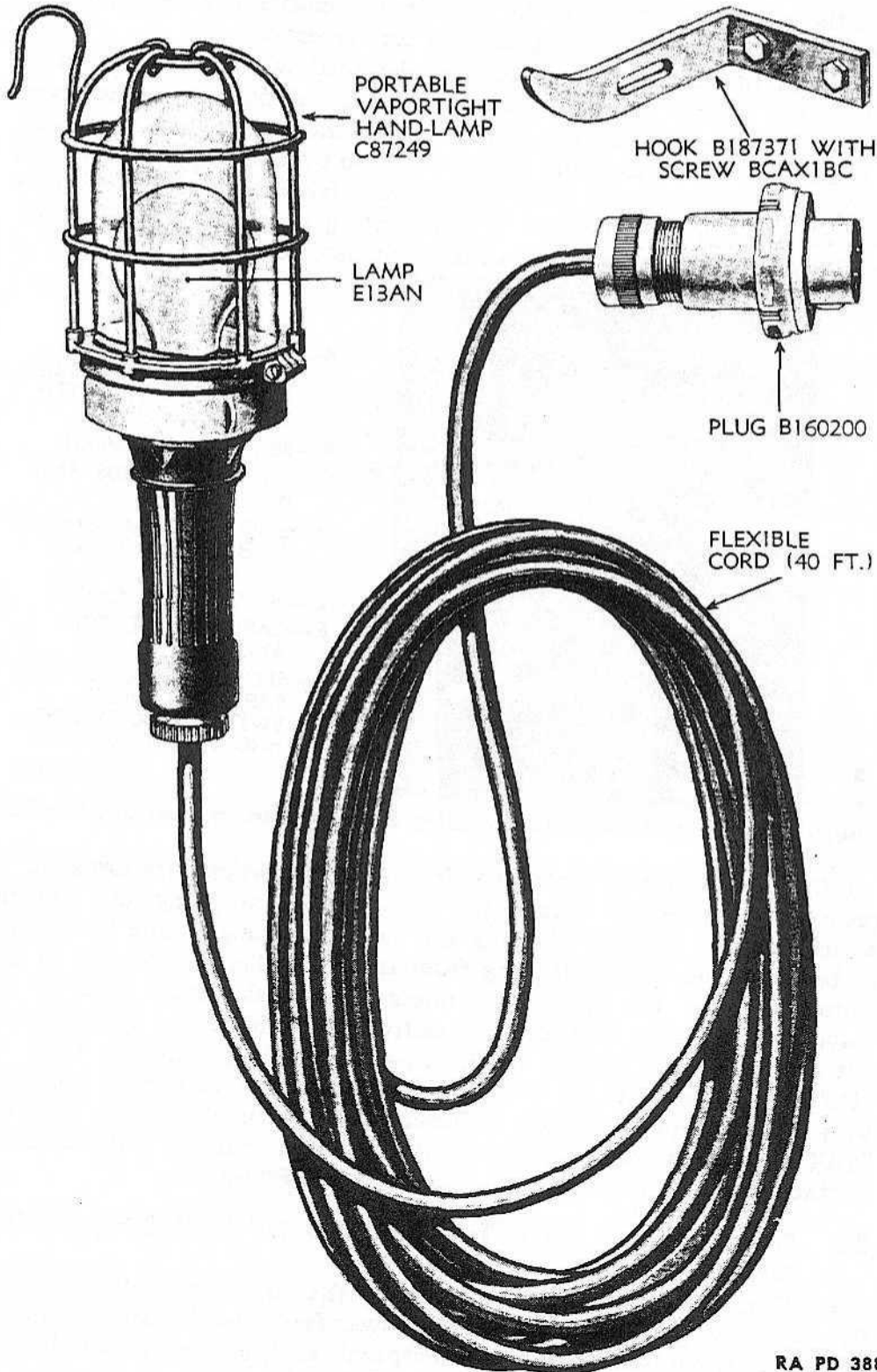

RA PD 38851

**Figure 169—Hand Lamp, Assembly**

**ELECTRICAL EQUIPMENT**

(1) All lighting cable (figs. 163, 164 and 165) is made up of two-conductor No. 14 stranded, seven strands No. 22, tinned copper wire, coded white and black, outside diameter 0.530 inch. The total length required for one mount is approximately 326 feet.

(2) Flexible cords (figs. 159 and 160) for sight lights consist of two-conductor No. 16 stranded, 65 strands No. 34, tinned copper wire, coded white and black, outside diameter 0.405 inch, total length approximately 20 feet.

(a) The flexible cords for sight lighting carry 12- to 16-volt current for the two-candlepower lamps at the right and left sights.

(3) **MAIN LIGHTING TRANSFORMER.** From the main distribution box (G, fig. 151) current is carried to the main lighting transformer (E, fig. 151) located on the front right floor beam under the inner platform by means of a two-conductor cable consisting of two conductors each made up of seven strands of No. 14 tinned copper wire conductor, coded white and black, outside diameter 0.530 inch. The length of this cable is approximately three feet.

(a) At the main lighting transformer the current is reduced from 460 to 115 volts for lighting purposes.

(4) **LIGHTING DISTRIBUTION PANEL.** From the transformer the current is carried to the lighting distribution panel (H, fig. 161) and (fig. 162) located on the left side frame.

(a) This device consists of a hinged watertight panel box (E, fig. 162), panel board (G, fig. 162), fuses (D, fig. 162), terminals (C, fig. 162) and single-pole, double-blade tumbler switches.

(b) From the lighting distribution panel the cables carrying 115-volt current are routed to the various lamps, plug boxes and transformers on the carriage as indicated on the lighting circuit directory card (B, fig. 162) attached to the inside of the panel box cover.

(5) **SIGHT LIGHTING TRANSFORMERS.** Sight lighting transformers (fig. 95, and D, fig. 161), designed to reduce current from 115 volts to 16 volts, are located on the right and left side frames.

(a) The transformer (fig. 95) on the right frame reduces the voltage to the two-candlepower sighting lamps at the right telescopic sight.

(b) The transformer on the left side frame (D, fig. 161) reduces the voltage to the two-candlepower sighting lamps at the left telescopic sight (fig. 160), and also to the eight-candlepower lamp at the azimuth pointer (fig. 103).

(6) **PLUG BOXES.** The mount is equipped with a variety of plug boxes designed to provide convenient location for portable lamps and other lighting equipment.

(a) A special three-socket plug box (F, fig. 159) is located at the right and left telescopic sights for the two-candlepower lamps which provide illumination for the graduations on the sighting equipment.

(b) Seven special plug receptacles (fig. 166) are provided for plug-

### 16-INCH SEACOAST GUN MATERIEL GUN MK. II M1; BARBETTE CARRIAGE M4

ging in the portable vaportight hand lamps with which the mount is provided. These plug boxes are located at the following points: At the right front of the front transom; on the right side frame to the rear of the elevating gear plate; on the right side frame near the follow-up control handwheel; on the left side frame to the rear of the elevating gear plate; on the left side frame near the lighting distribution panel; attached to the bottom surface of the right side frame in the elevating motor compartment under the right inner platform; and attached to the floor beam in the air compressor and motor compartment under the left inner platform.

(7) **JUNCTION BOXES.** To provide a means for distribution of current to the various lighting devices on the mount, three- and four-way junction boxes are assembled at convenient points on the carriage.

(a) Three-way boxes (A, fig. 90, and E, fig. 165) are located at the right and left front face of the front transom; on the right and left side frames near the front web of the frames (G, fig. 163, and A, fig. 164). A three-way box (N, fig. 161) is located on the left side frame to the right of the lighting distribution panel.

(b) Four-way junction boxes (P, fig. 68, and N, fig. 163) are located on the right side frame below the elevating speed gear oil expansion tank and on the left side frame (H, fig. 164, and F, fig. 167) near the portable hand lamp hook.

(8) **SWITCH BOXES.** Switch boxes are provided throughout the lighting circuit for the purpose of controlling current to the various lamps.

(a) A two-way switch box (A, fig. 103) is located on the racer at the azimuth observer's cab under the outer platform.

(b) A three-way switch box (G, fig. 167) is located on the left side frame near junction box (F, fig. 167). An additional three-way switch box (P, fig. 161) is located on the left side frame below junction box (N, fig. 161) near the lighting distribution panel.

(c) A four-way switch box (G, fig. 168, and M, fig. 163) is located on the right side frame near the right sight lighting transformer (fig. 95, and L, fig. 163).

(9) **LAMP RECEPTACLE BOXES.** Two types of lamp receptacle boxes are used on the mount (fig. 166). One type is controlled by a snap switch which is an integral part of the receptacle. The other type is controlled by means of remote switches located in the lighting circuit.

(a) A snap switch type of receptacle box (H, fig. 74, and C, fig. 163) is located on the right side frame above the elevating handwheel (E, fig. 74), another on the upper surface of the frame near the trunnion elevation pointer (fig. 76, and C, fig. 163), and a third is located adjacent to the right slow-motion handwheel (fig. 76, and C, fig. 163). There are two snap switch type receptacle boxes located on the left side frame: One near the brake drum cover (fig. 83, and E, fig. 164); the other above the left slow-motion and traversing control handwheels (fig. 102, and

## ELECTRICAL EQUIPMENT

E, fig. 164). One snap switch type receptacle box is located on the left side of the front transom (J, fig. 90, and J, fig. 165).

(b) One remote controlled receptacle box (P, fig. 163) is located on the under side of the right side frame near the vertical elevating hand-wheel shaft; another is attached to the left intermediate floor beam in the air compressor and motor compartment (L, fig. 164); and a third is located on the racer at the azimuth observer's cab under the outer platform (D, fig. 165).

(10) LAMP JUNCTION BOX. A special lamp junction box (G, fig. 101) and (fig. 103) is attached by a bracket to the racer at the azimuth observer's cab under the outer platform. This device serves as a receptacle for the eight-candlepower lamp used for illuminating the graduations on the azimuth circle and azimuth pointer.

(11) PORTABLE LAMPS. Four portable hand lamps (fig. 169), each with approximately 40 feet of two-conductor flexible cord, special wire cages and 110-volt, 40-watt plugs, are provided for the mount. When not in use two of these lamps are hung on portable lamp hooks on the left side frame and one on the right side frame. One lamp is hung on a portable lamp hook assembled on the inside of the right side wall of the shield under the lower horizontal rib and opposite plug box (B, fig. 163) located near the follow-up control handwheel on the right side frame.

(12) CONNECTORS. A total of 67 watertight lighting cable connectors (E, fig. 161, and E, fig. 167) are provided for the various electrical devices on the carriage as follows: For main transformer, two; sight lighting transformers, five; distribution panel, seven; junction boxes, 22; switch boxes, 12; lamp receptacle boxes, nine; plug boxes, nine, and lamp junction box, one.

(13) LAMP HOLDERS. Six special lamp holders (K, fig. 159, and J, fig. 95) are assembled in the right and left telescopic sights and sight brackets for the two-candlepower frosted-bulb electric lamps used for illuminating the sighting equipment.

(14) LAMPS. All lamps used on the mount are of the frosted-bulb type. The main circuit and portable lamps, of which there are 13, are of 110-volt, 40-watt capacity. The six lamps used on the sighting equipment are bayonet-base, two-candlepower, 12- to 16-volt lamps. The single lamp provided for the azimuth pointer at the azimuth observer's cab is an eight-candlepower, 12- to 16-volt, elongated lamp with bayonet base.

### 33. OPERATION OF LIGHTING EQUIPMENT.

a. The current for lighting equipment is carried to the mount through the same cables that carry the current for power to the main distribution box. Therefore, in order to operate the lighting equipment the loop cable connecting the receptacles on the emplacement and racer must be assembled. Note precautions outlined in section III, paragraph 8 k (1) and (2).

**16-INCH SEACOAST GUN MATERIEL  
GUN MK. II M1; BARBETTE CARRIAGE M4**

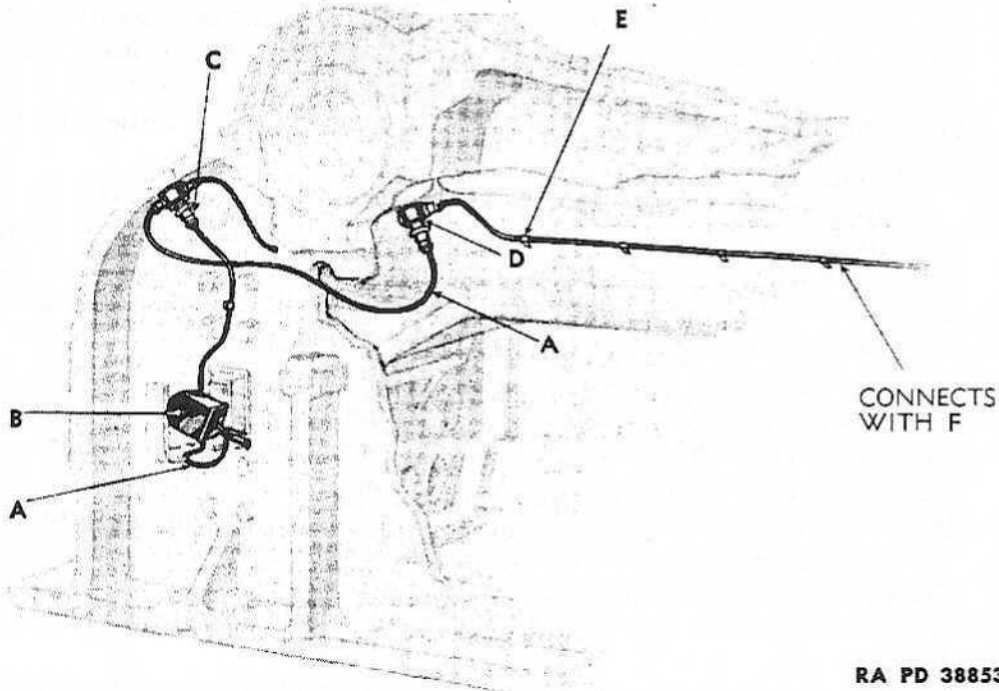

RA PD 38853

**Figure 170—Firing Circuit (Left Front Section)**

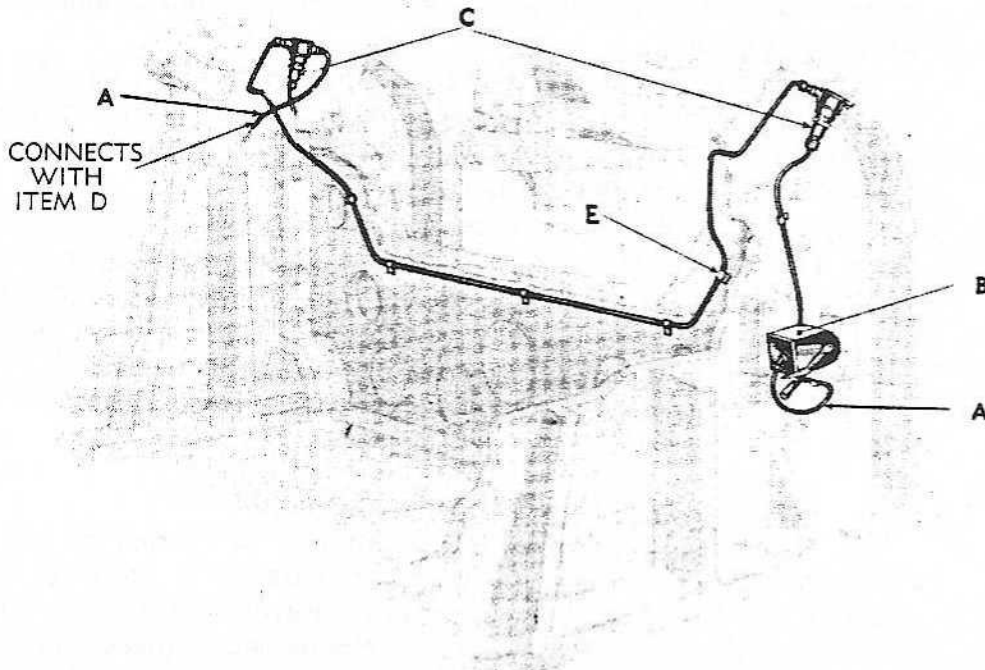

RA PD 38853A

**Figure 170-1—Firing Circuit (Right Firing Magneto)**  
(LEGEND ON OPPOSITE PAGE)

ELECTRICAL EQUIPMENT

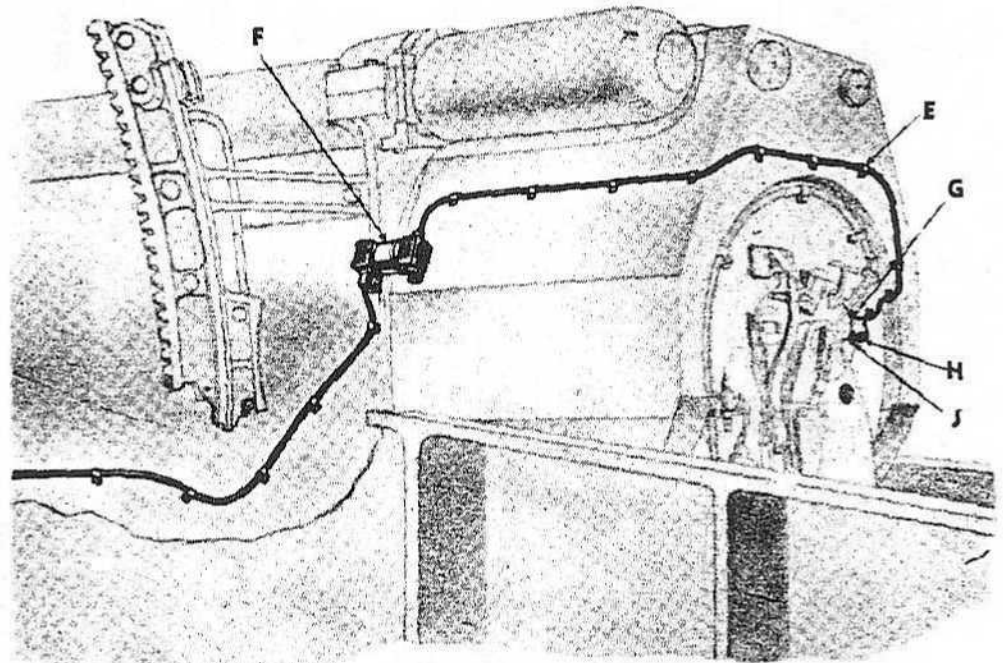

- |  |  |
|--|--|
| A — FIRING CIRCUIT FLEXIBLE CORD   | E — RECOIL FIRING CONTRACTOR ASSEMBLY 14-5-86    |
| B — FIRING MAGNETO D42367  | G — (GROUND) TERMINAL T97PA WITH SCREW BCGX2-1FH |
| C — FIRING CIRCUIT PLUG B160200  | H — CIRCUIT BREAKER CONTACT A422M                |
| D — PLUG RECEPTACLE HOUSING B128000 AND CONDULET B127998 (UNDER CRADLE TRUNNION) | J — CIRCUIT BREAKER                              |
| E — (SINGLE CABLE) CLAMP A217813 WITH SCREW BCAX1BA                              |  |

RA PD 38852

**Figure 170-2—Firing Circuit (Left Rear Section)**  
(ILLUSTRATIONS ON OPPOSITE PAGE)

16-INCH SEACOAST GUN MATERIEL  
GUN MK. II M1; BARBETTE CARRIAGE M4

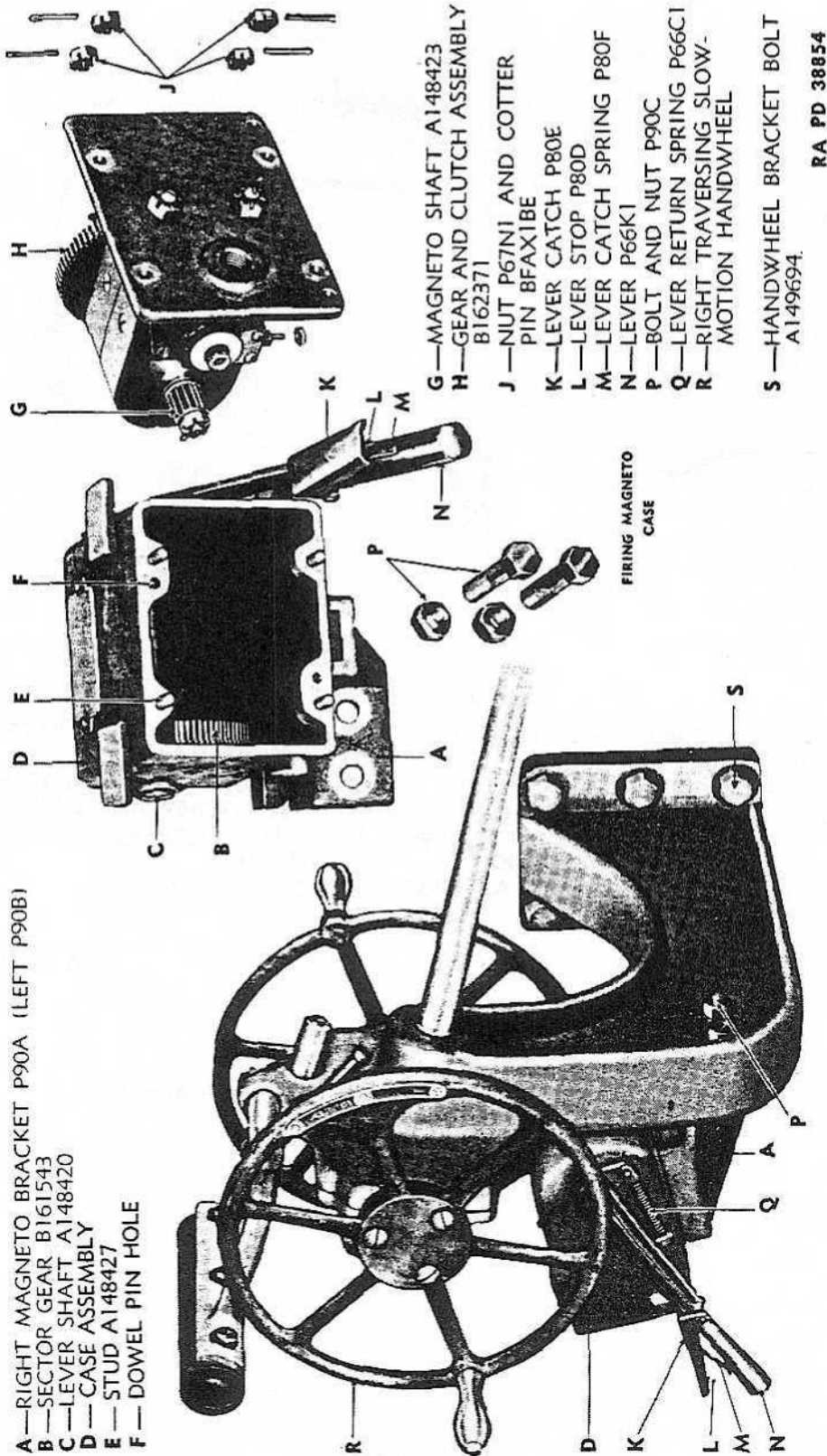
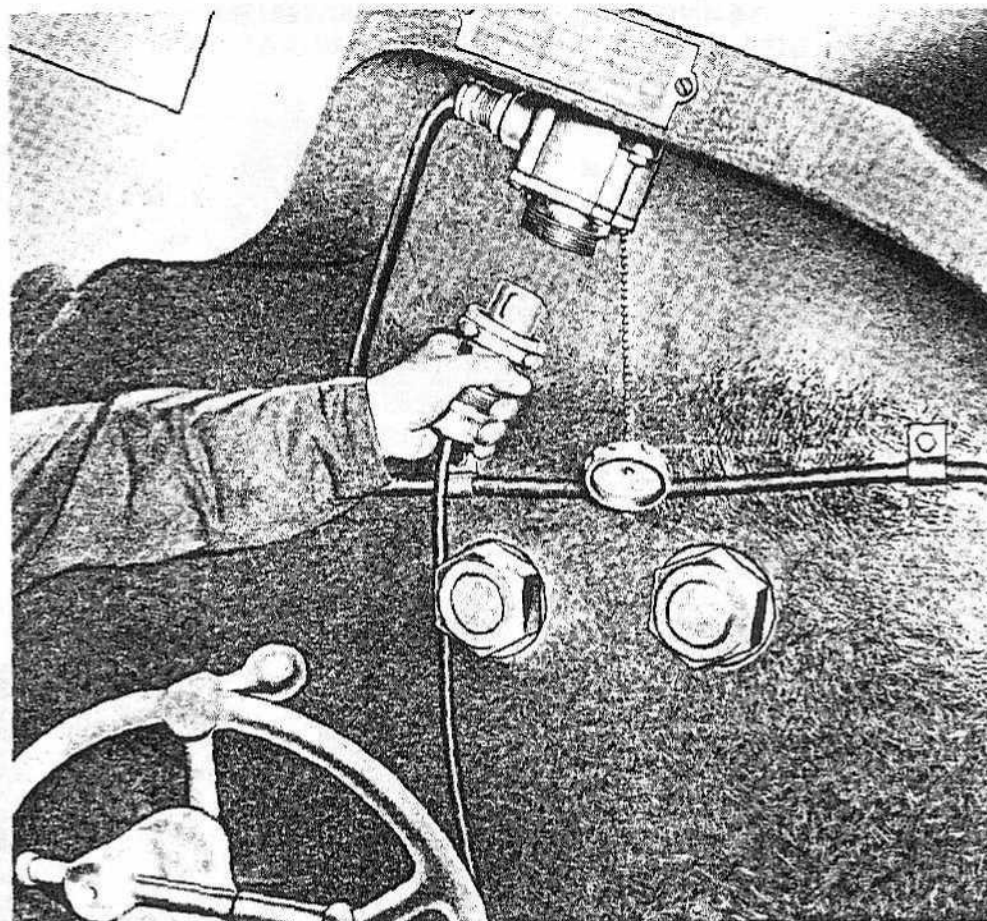

Figure 171—Firing Magneto (Right) in Place

**ELECTRICAL EQUIPMENT**



RA PD 38855

**Figure 172—Removing Firing Magneto Plug from Socket**

(1) **LIGHTING DISTRIBUTION PANEL.** The lighting distribution panel (H, fig. 161) and (fig. 162) contains "ON" and "OFF" tumbler snap switches for controlling the lights, plug boxes and transformers on the mount in accordance with circuit directory card (B, fig. 162) fastened to the inside cover of the distribution box. By operating these switches in accordance with the information on the directory card the current may be turned on or shut off from any section of the mount.

(2) **SIGHT LIGHTING EQUIPMENT.** The cords leading from the plug boxes (F, fig. 159) at the right and left sighting brackets are equipped on one end with bayonet-type plugs (G, fig. 159) to be inserted in the plug box and on the other end with a lamp holder assembly (K, fig. 159), which contains the bayonet-base, two-candlepower lamps for illuminating the sighting equipment. To operate the sighting lights insert the plug end of the cords in the openings in the plug box and turn the plug to the right to establish contact. Contact may be broken by turning the plug to the extreme left without removing the plug from the box. To remove the plug turn to the right or left until the projections on the plug are in alignment with the grooves in the plug sockets. Insert the lamp holder assembly containing the two-candlepower lamp in the



16-INCH SEACOAST GUN MATERIEL  
GUN MK. II M1; BARBETTE CARRIAGE M4

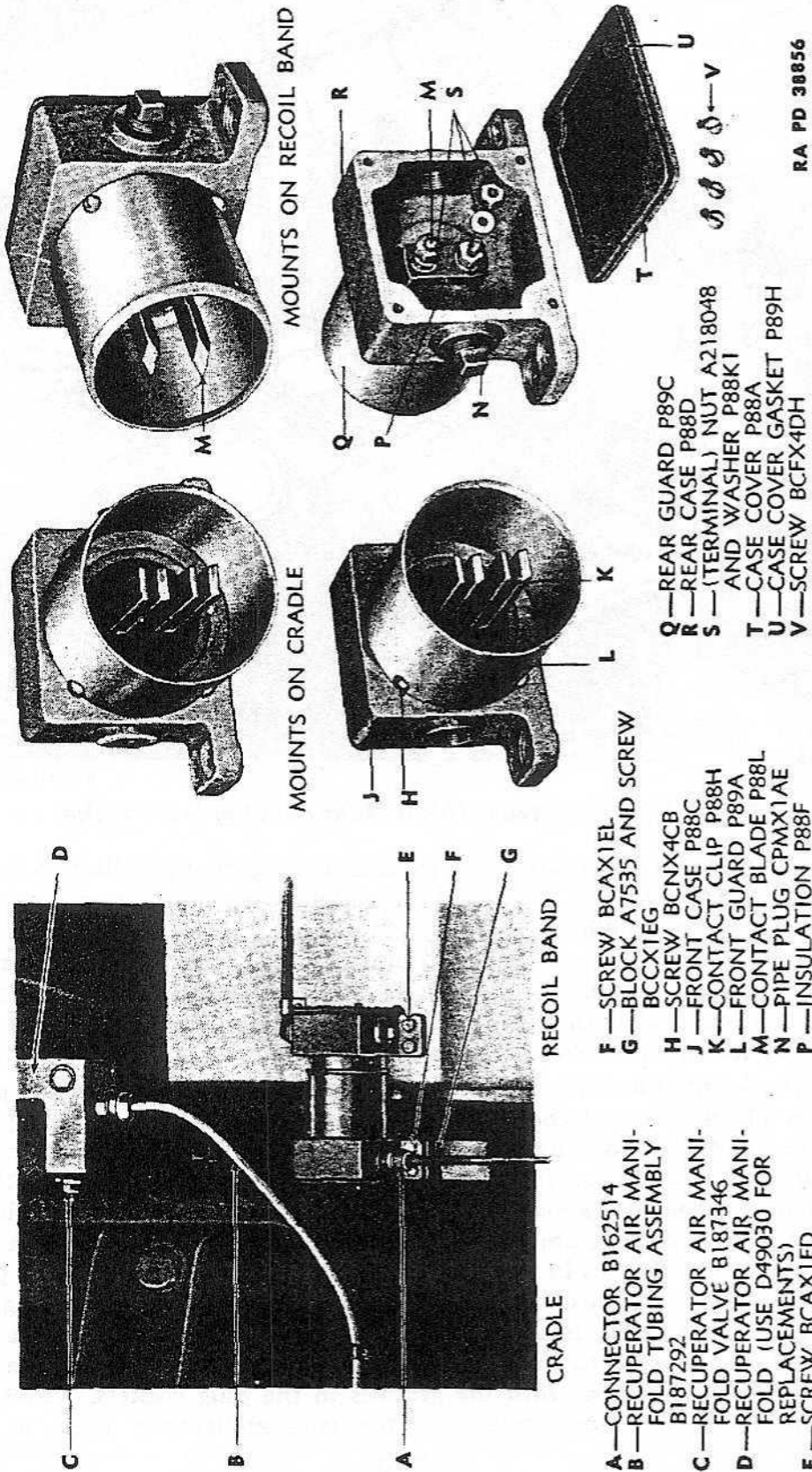

CRADLE  
A—CONNECTOR B162514  
B—RECUPERATOR AIR MANI-  
FOLD TUBING ASSEMBLY  
B187292  
C—RECUPERATOR AIR MANI-  
FOLD VALVE B187346  
D—RECUPERATOR AIR MANI-  
FOLD (USE D49030 FOR  
REPLACEMENTS)  
E—SCREW BCAX1ED

RECOIL BAND  
F—SCREW BCAX1EL  
G—BLOCK A7535 AND SCREW  
BCCX1EG  
H—SCREW BCNX4CB  
J—FRONT CASE P88C  
K—CONTACT CLIP P88H  
L—FRONT GUARD P89A  
M—CONTACT BLADE P88L  
N—PIPE PLUG CPMX1AE  
P—INSULATION P88F

MOUNTS ON CRADLE  
J—SCREW BCAX1EL  
H—SCREW BCAX1EG  
K—CONTACT CLIP P88H  
L—FRONT GUARD P89A  
M—CONTACT BLADE P88L  
N—PIPE PLUG CPMX1AE  
P—INSULATION P88F

MOUNTS ON RECOIL BAND  
Q—REAR GUARD P89C  
R—REAR CASE P88D  
S—(TERMINAL) NUT A218048  
AND WASHER P88K1  
T—CASE COVER P88A  
U—CASE COVER GASKET P89H  
V—SCREW BCFX4DH

Figure 173—Recoil Firing Contactor

RA PD 30856

### ELECTRICAL EQUIPMENT

apertures provided for them in the telescopic sight and sight bracket. Press the lamp holder firmly in place to compress the lamp holder spring and turn the holder to the right to lock the part in place. The three wires leading from the lighting plug box to the sight bracket on each side of the mount are marked with metal tags indicating their proper location. The cord marked "MICROMETER" is assembled in the lower aperture in the sight bracket for illuminating the graduations on the micrometer at the left of the bracket. The "INDEX" cord is assembled in the aperture above the graduated index plate and the "CROSS WIRE" cord is assembled in the aperture in the telescopic sight containing the sighting cross wires. The plug boxes are not marked to indicate the position of each cord, and electrical contact can be made by inserting any plug in either of the holes in the plug box. The ends of the cords on which the plugs are assembled should, however, be inserted in the plug box in such manner as to avoid distorting or twisting the cords.

(3) **AZIMUTH LIGHTING.** The eight-candlepower elongated lamp at the azimuth indicator in the azimuth observer's cab (G, fig. 101) and (fig. 103) is of the bayonet type and is inserted in the lamp holder by pressing the lamp firmly in the socket and turning the lamp to the right to lock it in place. Current to this lamp is controlled by means of a remote control switch (A, fig. 103) located on the racer near the azimuth control handwheel.

(4) **GENERAL ILLUMINATION.** All 110-volt, 40-watt lamps on the mount are of the screw-base type. Their operation requires no explanation.

(a) The portable lamps (fig. 169), (A, fig. 163, and F, fig. 164) may be used in any of the lighting plug boxes for which they are designed. When not in use they must be hung on the lamp hooks provided for the purpose with the cable neatly coiled in place. Under no condition are they to be thrown carelessly about the mount where they might be broken or otherwise damaged. Portable lamps are plugged in and have no individual switches. To turn the current on or off, the tumbler switch in the lighting distribution panel box for the lamp receptacle must be operated. Current to each individual 40-watt lamp, except portable lamps, may be turned on or off by means of snap switches located in the lamp receptacle boxes, or by remote control switches in switch boxes located in the cable line leading to the lamp (fig. 167).

(5) **TRANSFORMERS.** The sight lighting transformers operate automatically and require no hand manipulation.

(6) Junction boxes are provided as a convenient means for connecting cable lines and require no action by the using service.

### 34. DESCRIPTION AND FUNCTIONING OF FIRING EQUIPMENT.

a. Current for firing the piece is generated on the mount by means of two firing magnetos located on the right and left sides of the carriage.

### 16-INCH SEACOAST GUN MATERIEL GUN MK. II M1; BARBETTE CARRIAGE M4

Either magneto may be operated independently to produce a firing spark; but the magnetos must not be operated simultaneously.

(1) **FIRING MAGNETOS.** The two firing magnetos (fig. 171) are designated as type RM. They are identical in construction and consist of the following principal parts: Magneto case (D, fig. 171), magneto (Edison Splitdorf type RM-1), operating lever (N, fig. 171), lever return spring (Q, fig. 171), lever shaft (C, fig. 171), magneto shaft (G, fig. 171), gear and clutch assembly (H, fig. 171), sector gear (B, fig. 171), ball bearings and terminals. Movement of the lever through its permissible arc of 40 degrees energizes the magneto and produces a spark sufficient to ignite the primer at the gun breech.

(a) The firing magneto on the right side is attached to a bracket (A, fig. 171) bolted to the right handwheel bracket.

(b) The magneto on the left side is attached to a bracket (T, fig. 93) assembled to the left handwheel bracket.

(2) **FIRING CABLES AND FLEXIBLE CORDS.** The firing cable (fig. 170) used on the mount is two-conductor No. 14 stranded, seven strands No. 22, tinned copper wire conductor, coded white and black. Outside diameter 0.530 inch, total length approximately 41 feet. This cable serves to connect the firing plug box (K, fig. 95) on the right side frame to a similar plug box on the left side frame and extends from the firing plug box (A, fig. 56) on the cradle near the left trunnion to the firing contactor (F, fig. 170-2) and (fig. 173) on the cradle and recoil band; and from the contactor to the circuit breaker contact (H, fig. 170-2) and ground terminal (G, fig. 170-2) on the gun breech.

(a) The flexible firing cord (A, fig. 170-2) designed to connect the magnetos to the firing cable plug boxes on the right and left side frames, and for connecting the plug box on the left side to the plug receptacle at the cradle trunnion is two-conductor No. 16 stranded, 65 strands No. 34 tinned copper wire conductor, coded white and black, outside diameter 0.405 inch, total length approximately 17.5 feet.

(3) **FIRING PLUG BOXES.** Special plug boxes (K, fig. 95, and A, fig. 56) are located under the outer front web of the right side frame near the cradle trunnion and on the outer surface of the cradle body under the left cradle trunnion.

(a) A special firing plug box (see fig. 172 for single-outlet plug box) (figs. 170 and 94) is located under the outer front web of the left side frame. This box is connected to the firing plug box on the right side frame by a two-conductor cable which is assembled across the inner face of the front transom (fig. 170-2). It is also connected by a two-conductor flexible cord and plug to the firing plug box on the left side of the cradle under the left trunnion (fig. 170-1). This latter plug box is the terminus of the cable leading to the firing contactor (F, fig. 170) and (fig. 170-2) on the left side of the cradle.

(b) Special plugs (C, fig. 170, and J, fig. 95) are assembled on the

## ELECTRICAL EQUIPMENT

ends of the flexible cords leading from the magnetos to the firing plug boxes and on the flexible cord connecting the plug boxes on the left side frame and under the left cradle trunnion, affording a means of making or breaking the circuit to either or both firing magnetos.

(4) **RECOIL FIRING CONTACTOR.** A recoil firing contactor (fig. 173, and F, fig. 170-2) is designed as a safety device to prevent firing of the piece except when in battery position. It is attached to the cradle and recoil band.

(a) One section (fig. 173) containing two split copper clips (K, fig. 173) enclosed in the front female guard (L, fig. 173) is attached to the cradle.

(b) One section containing two copper blades (M, fig. 173) enclosed in the rear male guard (Q, fig. 173) is attached to the recoil band of the gun.

(c) When the gun recoils in firing the contact between the clips and blades is broken and will not be reestablished until the gun returns to firing position, excepting that the gun may remain approximately three inches out of full battery position with contact between the clips and blades established.

(d) The blades and clips are mounted in similar firing contact cases (J and R, fig. 173) and are insulated by means of two vulcanized fiber or bakelite insulation blocks (P, fig. 173). Two steel retaining rings hold the insulation in place in the contact case. Each contact case is provided with a bronze cover (T, fig. 173) and tapped holes are provided on alternate sides of the cases for assembly of the Crouse Hinds connectors (A, fig. 173) on the ends of the firing cable. Holes on the opposite sides are closed by  $\frac{3}{4}$ -inch standard pipe plugs (N, fig. 173). Cable terminals on the ends of the firing cables are attached to the copper clips and blades by means of brass nuts (S, fig. 173) supported by brass washers in contact with the insulation blocks.

(5) **FIRING CABLE CONNECTORS.** A 45-degree angle connector with clamping range of  $\frac{3}{8}$  to  $\frac{7}{16}$  inch is assembled in each magneto for the attachment of one end of the flexible cord connecting the magnetos to the firing plug boxes. The other end of this cord is equipped with standard Crouse Hinds plugs (J, fig. 95).

(a) A straight connector with clamping range of  $\frac{3}{8}$  to  $\frac{7}{16}$  inch is used to connect the flexible cord between the firing plug box on the left side frame and the firing plug box on the left side of the cradle under the cradle trunnion. All other connectors used in the firing circuit are Crouse Hinds type connectors with clamping range of  $\frac{1}{2}$  to  $\frac{5}{8}$  inch.

(6) **CIRCUIT BREAKER AND CIRCUIT BREAKER CONTACT.**

(a) The circuit breaker contact (fig. 29) is attached to the gun breech and, when in contact with the circuit breaker on the breechblock, provides a means for an uninterrupted flow of current to the primer in the firing lock.

(b) The circuit breaker (fig. 29) is attached to the breechblock and

**16-INCH SEACOAST GUN MATERIEL  
GUN MK. II M1; BARBETTE CARRIAGE M4**

is in contact with the circuit breaker contact only when the breechblock is completely closed. Rotation of the breechblock in the process of opening the breech breaks the electric circuit to the firing lock.

(7) **FIRING LOCK.** The firing lock (figs. 28 and 29) is of the Mark I Navy type. It is assembled on the end of the obturator spindle (J, fig. 11) in the breechblock and is connected by a firing lock operating bar (fig. 21, and C, fig. 19) to the mechanical parts of the breech mechanism. Manipulation of the breech mechanism in opening the breechblock activates the operating bar to open the firing lock, for the insertion or ejection of the firing primer. Closing the breechblock automatically closes the firing lock (T, fig. 19) and brings the circuit breaker (V, fig. 19) into contact with the circuit breaker contact (Y, fig. 19). The circuit breaker is connected to the firing lock by means of a flexible firing cable (AG, fig. 28) which is fastened by a clip to the face of the breechblock. One end of the cable is inserted in the circuit breaker. The other end which is provided with a special terminal fitting (AF, fig. 28) is assembled by means of a terminal stop (H, fig. 28) to the firing lock.

**35. OPERATION OF FIRING EQUIPMENT.**

a. Current for firing the piece is generated by means of the firing magnetos which are attached to the right and left handwheel brackets.

(1) **MAGNETOS.** Either magneto may be used to fire the piece through a circuit extending from the magneto to the circuit breaker on the gun breech. The magnetos should not be operated simultaneously as such action might tend to decrease the volume of current to the firing contact and result in a possible misfire.

(a) To fire the piece from either side of the mount, first remove the magneto plug (fig. 172) from the firing plug box which is attached to the front web of the side frame on the opposite side. Assemble the plug in the firing plug box on the side from which the magneto is to be operated (fig. 172 is a right side view).

(2) **FIRING PLUGS AND BOXES.** Be assured that the firing plug (fig. 172) on the end of the firing cord leading from the plug box on the left side frame is assembled in the plug box (A, fig. 56) on the gun cradle under the left trunnion. To assemble this plug it is necessary to insert hand and arm in the five-inch opening (fig. 142) provided for this purpose in the left side frame near the left trunnion.

(3) **CONNECTORS AND COVERS.** The plugs assembled on the firing cords are each provided with a connector nut which must be screwed onto the receptacle when the plugs are assembled. Each receptacle is also provided with a closing cover which must be assembled on the receptacle when the firing plugs are removed.

(4) The safety firing contactor (fig. 173) connecting the circuit at the cradle and recoil band operates automatically and requires no hand manipulation.

(5) The circuit terminals on the gun breech are securely fastened

## ELECTRICAL EQUIPMENT

in place and operation of the parts to which the terminals are attached is regulated by the opening and closing of the breechblock.

(a) To energize the magneto (fig. 171) and produce a spark sufficient to fire the piece, grasp the firing lever (N, fig. 171) in such manner as will release the lever catch (K, fig. 171) on the upper surface of the lever. Pull the lever briskly upward to cover the full permissible movement of 40 degrees and release the lever which will be returned to its locked position by action of the lever return spring (Q, fig. 171). If the primer fails to fire when the magneto is operated two or three times in accordance with the above instructions, no further effort will be made to repeat the operation until an investigation has been made as to the cause of such failure, which may have resulted from a "break" in the circuit between the magneto and the firing lock or because of a defective primer.

### 36. CARE AND PRESERVATION OF POWER, LIGHTING, AND FIRING EQUIPMENT.

a. In order to insure satisfactory operation of the electrical equipment, it is necessary that the several parts of the mechanisms be given careful attention.

(1) LUBRICATION. See that the moving parts of the motors and speed gears are properly lubricated in accordance with instructions outlined in the Lubrication Guide.

(2) CABLE LOOP. When not in use the cable loop connecting the receptacles on the emplacement and racer should be removed and stored in a safe, dry place. Avoid sharp kinking or bending of the cable in assembling, disassembling or storing. Assemble cover caps on the cable receptacles after the cable loop has been disassembled to prevent dirt or moisture from entering the receptacles.

(3) BOX AND PANEL COVERS. See that the hinge covers on the main distribution box (fig. 152) and lighting distribution panel (fig. 162) are properly assembled and that covers on the lighting transformers (figs. 95 and 161) and other parts of the equipment are securely fastened in place.

(4) FASTENINGS. Check all motors, speed gears, controllers, distribution boxes, panels, junction boxes, switch boxes, plug boxes, receptacle boxes and similar devices in the electric wiring circuit to see that the holding screws are securely in place. If any of the equipment has been loosened due to firing shocks or other causes, corrective action will be taken.

(5) CONNECTORS. Test cable connectors at all boxes and other containers to ascertain that they are properly in place. These connectors are designed to prevent moisture from entering the various containers and must be assembled securely in position.

(6) OIL RESERVOIRS. See that all reservoirs supplying oil to the speed gears are filled to prescribed levels with proper grade of oil as outlined in Lubrication Guide.

**16-INCH SEACOAST GUN MATERIEL  
GUN MK. II M1; BARBETTE CARRIAGE M4**

(7) **TRAVERSING LIMIT SWITCH.** Check condition of the parts of the traversing limit switch and see that the rail attached to the base ring and the wheel on the limit switch arm (fig. 104) are clean and free from grease, dirt or other foreign matter and that moving parts are properly lubricated.

(8) **CABLE CLIPS.** Check all cable clips to insure that the cables are securely fastened to the gun and carriage. If clips have become loosened, they should be tightened.

(9) **PORTABLE LAMPS.** Check condition of the portable lamp cables and if injured make replacements or repairs as necessary. When not in use see that portable lamps and cables are hung on the hooks provided for them. Lamps should be plugged in frequently to see that they are in working order.

(10) **LIGHT SWITCHES.** Check the various lighting switches at frequent intervals to see that all lamps in the circuits can be turned "ON" or "OFF" as required. Remove defective lamp bulbs and replace with serviceable bulbs.

(11) **FIRING MAGNETOS.** Check the operation of the firing magnetos to determine that the current is being carried to the gun breech. This may be accomplished by operating the magneto lever and testing the cable terminal on the gun breech to see that the line is energized.

(12) **FIRING LOCK.** The firing lock described in paragraph 34 a (7) should be lubricated and manipulated frequently to insure its being in proper working condition at all times. When the mount is to be in a state of disuse for a considerable period of time, the firing lock should be removed and stored in its case in a safe, dry place.

(13) **FIRING CONTACTOR.** The interior parts of the firing contactor connecting the cables at the recoil band and cradle cannot be thoroughly examined except by removing the sections of the contactor. These parts will not be removed except to locate a cause of malfunctioning of the firing circuit.

(14) **SIGHT LIGHTING CORDS.** The lighting cords connecting the lighting plug boxes (F, fig. 159) to the sight lamps should be examined frequently to see that all the parts are in serviceable condition. If the cords, holders or cable connectors have been injured, they should be repaired or replaced. If the mount is to remain in a state of disuse for a considerable time, the cords and pertaining parts should be disassembled from the plug boxes and lamp receptacles and stored in a safe, dry place.

**37. INSPECTION.**

a. Necessary information relative to inspection of electrical equipment is contained in paragraph 36 under "Care and Preservation" and in paragraph 38 under "Malfunctions and Corrections."

**ELECTRICAL EQUIPMENT****38. MALFUNCTIONS AND CORRECTIONS.**

a. **General.** Uninterrupted service of the parts of the electrical equipment is vital to the proper operation of the mount and any evidence of malfunction of the parts will be given immediate attention.

(1) **POWER EQUIPMENT.** The current supplied to the mount for the operation of the power equipment is 440 volts; and caution will be exercised to avoid making repairs or replacements of parts while the current is turned "ON." Except in cases of emergency, all defects in the power equipment should be corrected by trained ordnance personnel. It is important that the covers of all boxes, panels and similar equipment be securely in place to prevent entrance of dirt and moisture to the electrical parts which might result in malfunctioning of the materiel.

(2) **LIGHTING EQUIPMENT.** Failures in lighting circuits are generally due to defective fuses, loosened terminals, broken or damaged lighting cords or cables, loosened lamps, or improper seating of plugs in their receptacles. When repairs or corrections are necessary on any of the parts of the lighting circuits, care must be exercised to see that the current in the defective circuit is *shut off* while repairs or corrections are being made. All defective fuses removed from the lighting panel, transformers, or other parts of the mount should be destroyed or definitely marked to indicate that they are unserviceable.

(3) **FIRING EQUIPMENT.** Malfunction of the parts of the firing circuit is liable to result in serious injury to the materiel and personnel; extreme care will be exercised to see that any existing defects are promptly remedied.

(4) **MISFIRES.** A misfire occurs when the piece fails to fire. Misfire is caused by:

(a) Failure of the primer to fire.

(b) Failure of the propelling charge to ignite when the primer fires

(c) When a misfire occurs all personnel *must* remain clear of the path of recoil of the piece.

(d) The piece must be kept pointed at the target or at a safe point within the field of fire.

(e) If the primer is heard to fire, a new primer must not be inserted or the breechblock opened until after 10 minutes have elapsed. At the expiration of 10 minutes, insert a new primer.

(f) If the primer has failed to fire, at least three attempts will be made to fire it before it is removed. If a special device is available by which the primer can be safely removed by a person standing clear of the path of recoil, the primer may be removed and examined after two minutes have elapsed since the last attempt to fire. When the primer has been removed under the above conditions insert a new primer and continue firing. If no special device as above referred to is available, the primer *must not* be removed or the breechblock opened until 10 minutes have elapsed since the last attempt to fire.



**16-INCH SEACOAST GUN MATERIEL  
GUN MK. II M1; BARBETTE CARRIAGE M4**

Malfunction	Cause	Correction
(5) POWER CIRCUIT.		
(a) Failure of any motor to start when push button is pressed.	1. Improper assembly of power loop caused by failure to screw connector nuts on cable securely onto receptacles on the racer or emplacement.	1. Assemble connector nuts securely in place.
	2. Failure to connect the supporting chains on the loop cable to racer and emplacement.	2. Connect supporting chains (make test by turning on lights to insure that current is being supplied to mount).
	3. Defective connections in push-button station.	3. Report to ordnance maintenance personnel.
	4. Loose terminals in main distribution box.	4. Tighten terminals. (PRECAUTION: Disconnect power cable loop before attempting to tighten terminals at any point in power line.)
	5. Short circuit in motor controller.	5. Operate manual lever on controller box by moving the lever counterclockwise to full "OFF," "RESET" position. Then return lever to "ON" position. If trouble continues report to ordnance maintenance personnel.
	6. Defective or improperly adjusted brushes on motor.	6. Refer to ordnance maintenance personnel.
(b) Motor overload.	1. Will be recognized by overheating of motor causing odor of burning oil or insulation.	1. Stop motor and report to ordnance maintenance personnel.

**ELECTRICAL EQUIPMENT**

Malfunction	Cause	Correction
	2. Presence of foreign matter in moving parts.	2. Examine all points where foreign matter may have lodged. Remove. Test operation of motor. If overload is still evidenced, report to ordnance maintenance personnel.
(c) Failure of motor to stop when limit switch wheel contacts switch rail on base ring.	1. Broken spring in limit switch. Deformation of switch arm or arm shaft.	1. Report to ordnance maintenance personnel.
	2. Failure of the limit switch cam wheel to contact rail on base ring due to loosened holding screws.	2. Tighten screws.
<b>(6) LIGHTING CIRCUIT.</b>		
(a) Failure of entire lighting circuit.	1. Improper assembly of cable loop on emplacement and racer.	1. Proceed as outlined in step (5) (a) 1. in "Power Circuit."
	2. Loosened terminal on lighting circuit cable in main distribution box.	2. Disconnect power line at racer or emplacement and tighten terminal.
	3. Broken cable between main distribution box and main lighting transformer.	3. Refer to ordnance maintenance personnel.
	4. Defective fuses.	4. Replace.
	5. Burned out transformer.	5. Refer to ordnance maintenance personnel.
	6. Broken cut-out.	6. Refer to ordnance maintenance personnel.
	7. Loose terminals in main transformer.	7. Disconnect power line at racer or emplacement. Tighten terminals.
(b) Lack of current in any group circuit, as indicated on circuit directory on inside of lighting distribution panel cover.	1. Defective fuse in lighting distribution panel.	1. Replace.

**16-INCH SEACOAST GUN MATERIEL  
GUN MK. II M1; BARBETTE CARRIAGE M4**

Malfunction	Cause	Correction
(c) Lack of current from sight lighting transformers to two-candlepower lamps at right and left sights and eight-candlepower lamp at azimuth observer's cab.	2. Defective tumbler snap switches in lighting distribution panel.	2. Refer to ordnance maintenance personnel.
	1. Defective fuses in sight lighting transformers.	1. Replace.
	2. Burned out transformers.	2. Refer to ordnance maintenance personnel.
	3. Loose terminals in sight lighting transformers.	3. Tighten terminals.
	4. Broken cut-out.	4. Refer to ordnance maintenance personnel.
	5. Defective or broken springs in right or left sight lighting plug boxes.	5. Refer to ordnance maintenance personnel.
	6. Failure of plugs on the sight lighting cords to make proper contact in sight lighting plug boxes.	6. Refer to ordnance maintenance personnel.
(d) Failure in portable hand lamp.	7. Broken sight lighting cords.	7. Refer to ordnance maintenance personnel.
	1. Loose bulb.	1. Screw bulb in socket securely.
	2. Burned out bulb.	2. Replace with new bulb.
	3. Plug improperly assembled in receptacle.	3. Push plug in receptacle and tighten connector nut securely.
	4. Broken wire in plugs or light socket handle.	4. Refer to ordnance maintenance personnel.
(e) Failure in two-candlepower lamps.	5. Broken cord.	5. Replace with new cord.
	1. Burned out bulb.	1. Replace with new bulb.

## ELECTRICAL EQUIPMENT

Malfunction	Cause	Correction
	2. Flexible cord plug inserted in plug box improperly.	2. Turn plugs to extreme right to make contact.
	3. Broken wire in plugs or light sockets and plug box connectors.	3. Refer to ordnance maintenance personnel.
	4. Defective cord.	4. Replace with new cord.
	5. Loose connection in plug box and plug box connectors.	5. Tighten.
<b>(7) FIRING CIRCUIT.</b>		
(a) Firing magneto fails to generate spark.	(a) Loose terminals.	(a) Tighten.
(b) Difficulty in operation of magneto lever.	(b) Deformed teeth on sector, shaft clutch gear, or magneto pinion.	(b) Refer to ordnance maintenance personnel.
(c) Failure of magneto lever to return to inactive position.	(c) Weak or broken lever return spring.	(c) Replace.
(d) Failure of magneto lever locking latch to engage.	(d) Weak or broken lever latch spring.	(d) Replace.
(e) Break in circuit at either of the three plug receptacle boxes on side frames and cradle.	1. Loose terminals.	1. Tighten.
	2. Cable plugs improperly assembled.	2. Push plug all the way in and assemble connector nut securely in place.
(f) Break in the circuit at firing contactor.	1. Loose terminals.	1. Remove case cover and tighten terminals.
	2. Deformation of clips or blades in contactor case.	2. Refer to ordnance maintenance personnel.
(g) Break in the circuit at breech housing contact.	(g) Loose connection between cable terminal and contact stud.	(g) Tighten crown nut on contact stud.

**16-INCH SEACOAST GUN MATERIEL  
GUN MK. II M1; BARBETTE CARRIAGE M4**

Malfunction	Cause	Correction
(h) Break in circuit between contact stud and circuit breaker contact pin.	1. Weak or broken circuit breaker contact spring.	1. Refer to ordnance maintenance personnel.
	2. Grease or oil on contact stud surface or circuit breaker contact pin.	2. Clean surfaces.
(i) Failure in circuit between circuit breaker contact pin and contact terminal.	(i) Broken firing cable.	(i) Refer to ordnance maintenance personnel.
(j) Failure of electric current through firing lock.	1. Improper contact between firing cable terminal and contact terminal due to the terminal stop being out of locked position.	1. Set terminal stop properly.
	2. Weak or broken terminal nut spring.	2. Refer to ordnance maintenance personnel.
(k) Break in circuit between contact hammer and firing pin.	1. Failure of hammer to return to set position due to abrasions.	1. Refer to ordnance maintenance personnel.
	2. Presence of foreign substances.	2. Remove cause.
	3. Deformation of hammer thrust pin.	3. Refer to ordnance maintenance personnel.
	4. Weak or broken firing spring.	4. Refer to ordnance maintenance personnel.
	5. Weak or broken firing pin spring.	5. Refer to ordnance maintenance personnel.
(l) Failure of primer to fire.	(l) Defective, distorted or broken primer in primer seat.	(l) Remove primer. Note precautions to be observed as outlined under "Misfires."

**39. ASSEMBLY AND DISASSEMBLY.**

a. **General.** For the most part necessary information covering the disassembly and assembly of electrical equipment is covered in this section under the headings "Description and Functioning, Operation, Care and Preservation, Inspection, Malfunctions and Corrections." The following points regarding the handling of the electrical equipment are intended to amplify or emphasize the information already furnished.

## ELECTRICAL EQUIPMENT

(1) **POWER LOOP.** To disassemble power loop, back off the connector nuts from the receptacles on the racer and emplacement. Unhook the chains from the brackets on the emplacement wall and racer, pull the plugs out of the receptacles and screw the covers onto the receptacle openings. In order to exclude dirt and moisture from the receptacle openings, covers must always be assembled tightly on the cable loop receptacles when the loop is removed. The chain assembled 18 inches from the end of the loop is attached to the bracket on the racer. The chain assembled 31 inches from the end of the loop is attached to the bracket in the wall of the emplacement.

(2) **MAIN DISTRIBUTION BOX.** The cover on the main distribution box is fastened in place by means of wing nuts. When the cover is opened for the purpose of tightening terminals or for any other purpose care will be exercised to see that wing nuts are screwed securely in place when the cover is again closed. *The terminals in this box must never be handled while the current is "ON" as such action might well result in serious injury to the operator.*

(3) **MOTOR CONTROLLERS.** The construction of the motor controllers is such that no effort to disassemble or assemble the controllers will be made by the using service. They will be handled by the service only so far as may be necessary to reset the controller yoke in the event of a short circuit as described in paragraph 31 a (9) under the heading "Operation of Power Equipment."

(4) **PUSH-BUTTON STATIONS.** Push-button stations will not be disassembled or assembled by the using service.

(5) **TRANSFORMERS.** The covers of the main lighting transformer, sight lighting transformers and plug boxes are secured in place by machine screws. When it becomes necessary to remove these covers for the purpose of tightening terminals or for any other purpose, care will be exercised to insure that the covers are reassembled tightly to avoid entrance of dirt or moisture into the transformers or plug boxes.

(6) **SIGHT LIGHTING PLUGS AND PLUG BOXES.** The plugs on the ends of the cords leading from the sight lighting plug boxes to the sights are of special construction and the plugs and boxes are so designed as to enable the operator to assemble and disassemble the plugs in the boxes quickly and with a minimum of effort. To turn the current "ON" to any lights insert the plug in the box and turn clockwise as far as possible. To extinguish the light turn counterclockwise as far as possible. To assemble or remove the plug turn to the right or left until the projection on the plug is in alinement with the groove in the box receptacle and push into place or withdraw as required.

(7) **PORTABLE HAND LAMPS.** Plugs on the ends of portable lamp cords are of the push variety and each plug is equipped with a connector nut which should be screwed onto the end of the receptacle when the plug is inserted. When plugs are withdrawn from the receptacles the covers should be screwed onto the end of the receptacle to exclude dirt and moisture.

**16-INCH SEACOAST GUN MATERIEL  
GUN MK. II M1; BARBETTE CARRIAGE M4**

(8) **FIRING MAGNETOS.** To disassemble either firing magneto from the mount it will be necessary to remove the firing magneto bracket from its seat on the handwheel bracket. The cord leading from the magneto to the magneto plug box on the side frame should not be disconnected from the magneto. The plug should be withdrawn from the plug box, and the cord clips removed from the side frame. The entire unit may be dismounted in this manner without disassembling the terminals in the magneto case. To assemble the unit the reverse order should be followed. Excepting for the purpose of replacing lever return spring or handle catch spring or for the purpose of assembling or tightening terminals in the magneto, the using service will not assemble or disassemble the parts of the magneto.

(9) **FIRING LOCK.** When the piece is to remain inactive for a considerable length of time the firing lock should be removed from the breech and stored in a safe, dry place.

(a) To remove the firing lock disconnect the firing cable (AG, fig. 28) from the firing lock terminal nut (N, fig. 28) by tipping the terminal stop (H, fig. 28) and removing the cable terminal (AF, fig. 28) from the nut. Now pull outward on the retracting lever latch (L, fig. 19) and operate the firing lock retracting lever (P, fig. 19) to open the firing lock and clear the firing lock safety arc (Z, fig. 19). Now pull downward on the firing lock operating bar latch handle (fig. 21) and release the firing lock from the operating bar. Turn the lock counterclockwise on the obturator spindle one-fourth turn until the interrupted threads in the firing lock are in proper alignment with corresponding recesses on the obturator spindle and remove the lock.

(b) To assemble the lock on the obturator spindle, the reverse order of operations will be followed.

(c) The component parts of the firing lock will not be assembled or disassembled by the using service.

Section IX

**SIGHTING AND FIRE-CONTROL EQUIPMENT**

(Data to be supplied when available)



**16-INCH SEACOAST GUN MATERIEL  
GUN MK. II M1; BARBETTE CARRIAGE M4**

**Section X**

**AMMUNITION**

	<b>Paragraph</b>
General .....	40
Nomenclature .....	41
Firing tables .....	42
Classification .....	43
Identification .....	44
Care, handling and preservation.....	45
Authorized rounds .....	46
Preparation for firing .....	47
Projectiles .....	48
Propelling charges .....	49
CHARGE, propelling, 6 equal sections, stacked, NH powder, 16- in. gun, Mk. II-Mod. 1 (Navy), 2240-lb. proj.....	50
CHARGE, propelling, 6 equal sections, stacked, NH powder, 16- in. gun, Mk. II-Mod. 1 (Navy), 2100-lb. proj. ....	51
CHARGE, propelling, dummy, 6 sections (120 lb. each), 16-in. guns, Mk. II-Mod. 1 (Navy) .....	52
Fuzes .....	53
FUZE, B. D., Mk. X .....	54
Primers .....	55
PRIMER, combination electric and percussion, Mk. XV-Mod. 1	56
Packing .....	57
Subcaliber ammunition .....	58
Field report of accidents .....	59

**40. GENERAL.**

a. Ammunition for the GUN, 16-inch, Mk. II-Mod. 1 (Navy), is of the separate loading type. The loading of each complete round into the cannon requires three separate operations. One, the projectile; two, the propelling charge; and three, the primer. These components are shipped separately. Armor-piercing projectiles for this gun are shipped fuzed.

**41. NOMENCLATURE.**

a. Standard nomenclature is used in this section in all references to specific items of issue.

**42. FIRING TABLES.**

a. For applicable firing tables, see the section of this Manual entitled "References."

## AMMUNITION

### 43. CLASSIFICATION.

a. The projectiles authorized for use in this gun are classified as armor-piercing, target-practice, and dummy. The armor-piercing projectile is a thick-walled shell fitted with an armor-piercing cap and filled with an explosive bursting charge. Target-practice projectiles are inert cast iron shot similar in size, shape, and weight to the service shell, or are service shell in which an inert filler is used in place of an explosive bursting charge. Dummy projectiles consist of a steel and bronze assembly of somewhat similar size, shape and weight to service projectiles; they are designed for training in handling projectiles and loading cannon, and are completely inert.

### 44. IDENTIFICATION.

a. **General.** Ammunition, including components, is completely identified by means of the painting, marking (including ammunition lot number), and data card or linen data tag. Other essential information is marked on the components, for example: On the projectile, its weight and the kind of filler; on the propelling charge, the weight of the igniter, designation of each section, etc. See figures 174 to 180, and the following paragraphs. The muzzle velocity may be obtained from the tag on the propelling charge.

b. **Mark or Model.** To identify a particular design, a model designation is assigned at the time the design is classified as an adopted type. This model designation becomes an essential part of the standard nomenclature and is included in the marking on the item. The present system of model designation consists of the letter "M" followed by an arabic numeral. Modifications are indicated by adding the letter "A" and the appropriate arabic numeral. Thus, "M3A1," indicates the first modification of an item for which the original model designation was "M3." Prior to July 1, 1925, it was the practice to assign mark numbers. The word "MARK," abbreviated "MK.," was followed by a roman numeral, for example: "SHELL, A. P. MK. XI." The first modification of a model was indicated by the addition of "MI" to the mark number, the second by "MII," etc. In case of items of Navy origin, the model designation oftentimes appears as "MK. II-MOD. 1-IN.," "MK. II-MOD. 2-IN.," etc.

c. **Ammunition Lot Number.** When ammunition is manufactured, an ammunition lot number, which becomes an essential part of the marking, is assigned in accordance with pertinent specifications. In the case of separate loading ammunition, such a lot number is assigned to, and marked on, each of the components—projectile, fuze, propelling charge, and primer—as well as on all packing containers and the accompanying data card. It is required for all purposes of record, including reports on condition, functioning, and accidents, in which the ammunition is involved. To provide for the most uniform functioning, all of the components in any one lot are manufactured under as nearly identical conditions as practicable. For example, in the case of projectiles, any one lot consists of projectiles made by one manufacturer, loaded by one

**16-INCH SEACOAST GUN MATERIEL  
GUN MK. II M1; BARBETTE CARRIAGE M4**

manufacturer, and of one weight. Therefore, to obtain the greatest accuracy in firing separate loading ammunition, successive rounds should consist of:

- Projectiles of one lot number (one type and one weight).
- Propelling charges of one lot number.
- Fuzes of one lot number.
- Primers of one lot number.

**d. Ammunition Data Card.** A five- by eight-inch card, entitled Ammunition Data Card because of the information thereon, accompanies each shipment of ammunition or ammunition components. In the case of separate loading propelling charges a linen tag containing essential data is attached to the charges in place of a data card. When required, assembling and firing instructions are printed on the reverse side of the card or tag. For regulations governing shipments of separate loading ammunition components, see OFSB 3-2.

**e. Painting and Marking.**

(1) **PAINTING.** All projectiles are painted to prevent rust and to provide, by the color, a ready means of identification as to type. For the projectiles described herein, the color scheme is as follows:

- Armor-piercing . . . . . Yellow; marking in black.
- Practice (inert) . . . . . Black; marking in white.\*
- Dummy or drill (inert) . . . . Black; marking in white, except band at center of gravity which is red.

(2) **MARKING.** For purposes of identification, the following is stamped or marked on the components of separate loading ammunition.

*(a) On the Projectile:*

*1. Stamped in the metal on the base:*

- Type, caliber, and model of projectile.
- Lot number of metal parts assembly.
- Weight of projectile.
- Manufacturer's initials or symbol.
- Year of manufacture.
- Serial No. of projectile (on base and on base plug).

*2. Stenciled on body:*

- Model or projectile (around body at center of gravity).
- Weight to nearest pound (on nose).
- Caliber and type of cannon in which fired (on nose).
- Kind of filler, for example, "EXP. D."
- Lot number of filled projectile.

---

\*It should be noted that the above color scheme is not wholly in agreement with the basic color scheme described in TM 9-1900, practice projectiles being generally painted blue.

## AMMUNITION

3. Navy projectiles used in this gun are marked in accordance with Navy practice.

(b) *On the Propelling Charges or Section Thereof (Stenciled):*

1. *On the body:*

Kind of charge, for example, " $\frac{1}{6}$  CHG."

Caliber and models of cannon for which adapted.

Weight or weights of projectiles with which charge may be used.

Powder lot (includes type of powder, the word "LOT," initials of manufacturer, serial number of lot, and year of manufacture).

2. *On the igniter:*

Weight, grade, and kind of igniter powder.

"IGNITER."

Caliber and models of cannon in which fired.

Month and year of loading.

3. *On dummy propelling charges:*

"DUMMY CHARGE" or "DUMMY PROPELLING CHARGE" together with the caliber and model of gun in which used.

(c) *On the Primer (Stamped in the Metal):*

Loader's initials.

Loader's lot number.

Year of loading.

Mark or model.

f. **Weight Markings.** Because it is not practicable to manufacture projectiles within the narrow limits required for the desired accuracy of fire, the actual weight of each projectile, to the nearest pound, is stenciled on the projectile body in order that the appropriate ballistic corrections indicated by firing tables may be applied.

## 45. CARE, HANDLING AND PRESERVATION.

a. Ammunition components are packed to withstand conditions ordinarily encountered in the field. Projectiles are shipped with a grommet to protect the rotating band, one projectile per wooden crate or box. Charges and primers are packed in moisture-resistant containers. Since ammunition and explosives are adversely affected by moisture and high temperature, the following precautions should be observed:

(1) Moisture-resistant seals should not be broken until the ammunition is to be used.

(2) Ammunition, particularly primers and propelling charges, should be stored in the original container, in a dry, well-ventilated place, protected from sources of high temperatures, including the direct rays of the sun. More uniform firing is obtained if successive rounds are at the same temperature.

b. Primers must always be stored in a dry place. Prolonged exposure to moisture or dampness may cause malfunctioning.

**16-INCH SEACOAST GUN MATERIEL  
GUN MK. II M1; BARBETTE CARRIAGE M4**

c. Explosive ammunition must be handled with appropriate care at all times. The explosive elements in primers are particularly sensitive to undue shock and high temperature.

d. Each of the separate loading components should be free of foreign matter—sand, mud, grease, etc.—before loading into the gun.

e. Components of rounds prepared for firing but not fired will be returned to their original condition and packings, and appropriately marked. Such components will be used first in subsequent firings, in order that stocks of opened packings may be kept at a minimum.

f. Propelling charges will be gaged for maximum diameter with gages furnished by the Ordnance Department. Charges which do not pass through the gage will not be fired.

**46. AUTHORIZED ROUNDS.**

a. The ammunition authorized for use in the GUN, 16-inch, Mk. II—Mod. 1 (Navy), is listed in the table below. No other ammunition will be used in this gun. The nomenclature completely identifies the ammunition. The use of standard nomenclature for all purposes of record is mandatory.

**b. Table I—Ammunition for Gun, 16-inch, Mk. II—Mod. 1 (Navy).**

Nomenclature of Fuzed Projectile	Propelling Charge (Model or Type)	Primer (Model)
<b>SERVICE AMMUNITION</b>		
SHELL, A. P., 2240-lb., Mk. 12, 16-in. Gun, Mk. II—Mod. I (Navy)*	6 equal sections <sup>1</sup>	Mk. XV—Mod. 1 <sup>2</sup>
PROJECTILE, A. P., 2100-lb., Mk. II—Mod. 2, 16-in. Guns, M1919-19MII-19MIII, Mk. II—Mod. 1 (Navy), or How., M1920	6 equal sections <sup>3</sup>	Mk. XV—Mod. 1 <sup>2</sup>
<b>PRACTICE AMMUNITION</b>		
SHELL, C. I., 2240-lb., M108, 16-in. Gun, Mk. II—Mod. 1 (Navy)	6 equal sections <sup>1</sup>	Mk. XV—Mod. 1 <sup>2</sup>
PROJECTILE, C. I., 2100-lb., M100, 16-in. Guns, M1919-19MII-19MIII, Mk. II—Mod. 1 (Navy), or How., M1920	6 equal sections <sup>3</sup>	Mk. XV—Mod. 1 <sup>2</sup>
PROJECTILE, A. P., (barium sulfate, paraffin, talcum filler), 2100-lb., Mk. II—Mod. 2, 16-in. Guns, M1919-19MII-19MIII, Mk. II—Mod. 1 (Navy), or How., M1920	6 equal sections <sup>3</sup>	Mk. XV—Mod. 1 <sup>2</sup>
PROJECTILE, A. P., empty, for sand loading, 2100-lb., Mk. II—Mod. 2, 16-in. Guns, M1919-19MII-19MIII, Mk. II—Mod. 1 (Navy), or How., M1920	6 equal sections <sup>3</sup>	Mk. XV—Mod. 1 <sup>2</sup>
<b>DUMMY AMMUNITION</b>		
PROJECTILE, dummy, 2240-lb., M5, 16-in. Gun, Mk. II—Mod. 1 (Navy)	6 sections <sup>4</sup>	Mk. XV—Mod. 1 <sup>2 5</sup>

(Continued on next page.)

**AMMUNITION**

Nomenclature of Fuzed Projectile	Propelling Charge (Model or Type)	Primer (Model)
PROJECTILE, dummy, 2100-lb., M3, 16-in. Gun or How.	6 sections <sup>4</sup>	Mk. XV—Mod. 1 <sup>2 5</sup>
PROJECTILE, dummy, 2100-lb., Mk. II, 16-in. Gun or How.	6 sections <sup>4</sup>	Mk. XV—Mod. 1 <sup>2 5</sup>
<b>SUBCALIBER AMMUNITION</b>		
SHELL, fixed, practice, sand loaded, Mk. I, 75-mm Gun (w/inert PDF Mk. IV or M47) <sup>6</sup>	Fixed	Fixed

A. P.—Armor-piercing.

B. D.—Base-detonating.

C. I.—Cast Iron.

<sup>\*</sup>—Formerly reported as: SHELL, A. P., 2240-lb., Mk. XI, 16-in. Gun, Mk. II—Mod. 1 (Navy).

<sup>1</sup>—Charge for service or practice firing is designated, charge, propelling, 6 equal sections, stacked, NH powder, 16-in. Gun, Mk. II—Mod. 1 (Navy), 2240-lb. proj.

<sup>2</sup>—Primer for service or practice firing is designated, PRIMER, combination electric and percussion, Mk. XV—Mod. 1.

<sup>3</sup>—Charge for service or practice firing is designated, CHARGE, propelling, 6 equal sections, stacked, NH powder, 16-in. Guns, Mk. II—Mod. 1 (Navy), 2100-lb. proj.

<sup>4</sup>—Dummy charge is designated, CHARGE, propelling, dummy, 6 sections (120-lb. each), 16-in. Gun, Mk. II—Mod. 1 (Navy).

<sup>5</sup>—A fired service primer is used with dummy ammunition for drill purposes.

<sup>6</sup>—SHRAPNEL, fixed, Mk. I, 75-mm Gun, may be used, if available, as ammunition for the subcaliber gun.

**47. PREPARATION FOR FIRING.**

a. Aside from removal of the packing material (including the grommet which protects the rotating band), the armor-piercing and practice projectiles are ready for firing. After removal from the cartridge storage case, the propelling charge is prepared for firing by removing the igniter protector caps and data tag as described in paragraph 50.

**48. PROJECTILES.**

a. **General.** The projectiles authorized for use in this gun are listed in paragraph 46, above. Detailed data of these projectiles appear in Table II, below. Although of the same general shape—cylindrical body, square base, and long ogival head—projectiles for the 16-inch Gun, Mk. II—Mod. 1 (Navy) differ in characteristic details as follows: (figs. 174 to 176, and fig. 182).

(1) **ARMOR-PIERCING CAP:** Used only with the armor-piercing projectiles.

(2) **WINDSHIELD OR FALSE OGIVE:** Used with armor-piercing projectiles to improve their ballistic efficiency.

(3) **RADIUS OF OGIVE:** Seven calibers for 2100-pound projectiles—nine calibers for 2240-pound projectiles.

(4) **BASE COVER:** Used with armor-piercing projectiles to prevent hot gases from the propelling charge from coming in contact with the bursting charge in the projectile through possible flaws or defects in the base.

**16-INCH SEACOAST GUN MATERIEL  
GUN MK. II M1; BARBETTE CARRIAGE M4**

**b. Table of Data.**

TABLE II.

Name		Nominal Weight in Pounds	Fuze		Length in Inches	Rotating Band		Filler		Shipped
Type	Model		Model	Action		Inches from Base	Width in Inches	Weight in Pounds	Type	
A. P.	Mk. 12‡	2240	B. D., Mk. X	Delay	64.28	2.5	5.33	34.2	EXP. D	Fuzed, Crated
A. P.	Mk. II—Mod. 2	2100	B. D., Mk. X	Delay	56.62	1.5	5.33	58.0	EXP. D	Fuzed, Crated
C. I.	M108	2240	—	—	64.20	2.5	5.33	—	—	Uncrated
C. I.	M100	2100	—	—	57.04	1.5	5.33	—	—	Uncrated
A. P.	Mk. II—Mod. 2	2100	B. D., Mk. X	Delay	56.62	1.5	5.33	—	*	Fuzed, Crated
A. P.	Mk. II—Mod. 2	2100	—	—	56.62	1.5	5.33	—	sand	Crated
Dummy	M5	2240	—	—	64.20	2	3.75	—	—	Crated
Dummy	M3	2100	—	—	58.52	2	3.75	—	—	Crated
Dummy	Mk. 11	2100	—	—	57.90	Sliding ring	4.75	—	—	Crated
Shell† fixed	Mk. I	16.15	P. D. Mk. IV or M47	Inert	23.77	1.67	.49	1.83	sand	9/box, or 3/bundle

\*Barium sulfate, paraffin, talcum filler.

†Subcaliber ammunition.

‡Formerly reported as the Mk. XI.

**49. PROPELLING CHARGES.**

a. The propelling charges used in this gun consist of a service charge and a dummy charge, both of the equal-section type. The service charge consists of smokeless powder in six bags, each section being of equal size. A black powder igniter charge, described in paragraph 50, is an integral part of each section. As shipped, the igniter end of each section is covered by an igniter protector cap. The dummy (drill) charge simulates the service charge in size, weight, and general appearance; it is provided for training in handling, and in service of the piece.

**50. CHARGE, PROPELLING, 6 EQUAL SECTIONS, STACKED, NH POWDER, 16-IN. GUN, MK. II—MOD. I (NAVY), 2240-LB. PROJ.**

a. **Description.** This service propelling charge (fig. 180) is composed of six equal sections. Each section consists of stacked grains of nonhydroscopic (NH) smokeless powder in a laced cloth bag. The full charge is 16 inches in diameter and has an over-all length (six sections) of 109½ inches. The full charge weighs approximately 661 pounds, the powder in the charge weighing 648 pounds. An igniter is assembled to each section and consists of black powder, in a pad sewed to the end of the section. The total igniter consists of 74.1 ounces of black powder—12.35 ounces in each section. The cloth of the igniter pads is dyed red to indi-

AMMUNITION

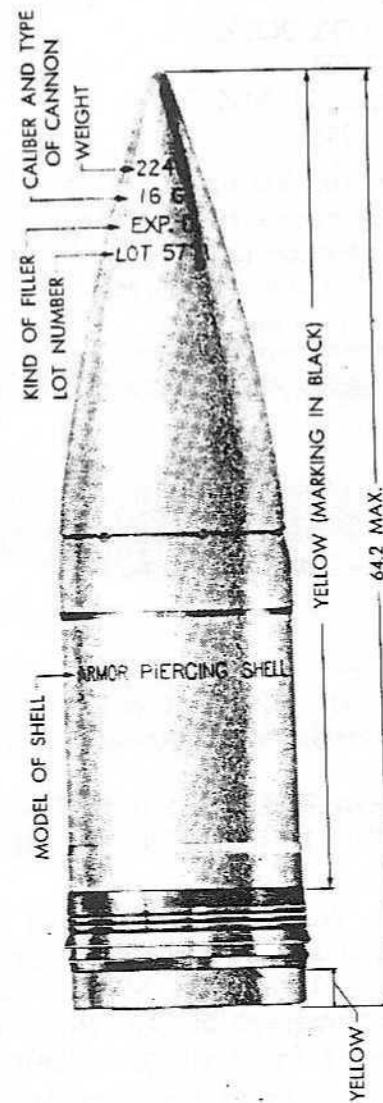

RA PD 2146

Figure 174—Shell, A. P., 2240-lb., Mk. XII, 16-in. Gun,  
Mk. II—Mod. 1 (Navy)



TM 9-471  
50-52

**16-INCH SEACOAST GUN MATERIEL  
GUN MK. II M1; BARBETTE CARRIAGE M4**

cate low explosive, in this case, black powder. All necessary data concerning the charge are contained on the data tag (par. 44). The following identifying markings are stenciled on each section of the charge:

ONE END  
12.35 OZ. A-1  
BLK. PDR. LOT XXX  
IGNITER  
16-IN. G. .50 CAL. N. MK. II  
OCT. 1935

SIDE  
FOR 2240-LB. PROJECTILE  
1/6-CHG.  
16-IN. G. .50 CAL. N. MK. II  
LOT XXX 1935

b. **Preparation for Firing.** To prepare each section of the charge for firing, it is only necessary to remove the igniter protector cap and the data tag. Each section must be loaded into the gun with the igniter end (cloth dyed red) toward the breech.

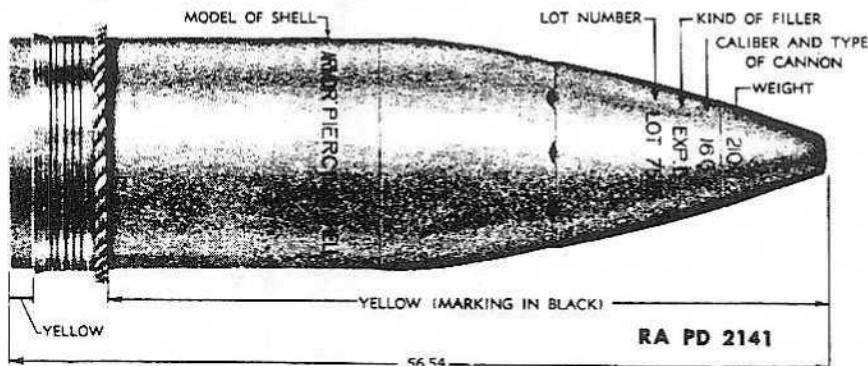

**Figure 175—Projectile, A. P., 2100-lb., Mk. II—Mod. 2, 16-in. Guns, M1919-19MII-19MIII, Mk. II—Mod. 1 (Navy), or How., M1920**

**51. CHARGE, PROPELLING, 6 EQUAL SECTIONS, STACKED, NH POWDER, 16-IN. GUN, MK. II—MOD. 1 (NAVY) 2100-LB. PROJ.**

a. **Description.** This service propelling charge is the same, except for quantity of powder, as CHARGE, propelling, 6 equal sections, stacked, NH powder, 16-in. Gun, Mk. II—Mod. 1 (Navy), 2240-pound proj., described in paragraph 50. The full charge weighs approximately 685 pounds, the powder in the charge weighing 672 pounds.

b. **Preparation.** To prepare each section of the charge for firing, it is only necessary to remove the igniter protector cap and the data tag. Each section must be loaded into the gun with the igniter end (cloth dyed red) toward the breech.

**52. CHARGE, PROPELLING, DUMMY, 6 SECTIONS (120 LB. EACH), 16-IN. GUNS, MK. II—MOD. 1 (NAVY).**

a. This dummy charge is used for drill purposes with the dummy projectiles listed in the table in paragraph 46. It is of the equal-section type simulating the service propelling charges described in paragraphs 50 and 51. The length of the full charge is 111 inches. The full charge

AMMUNITION

RA PD 2142

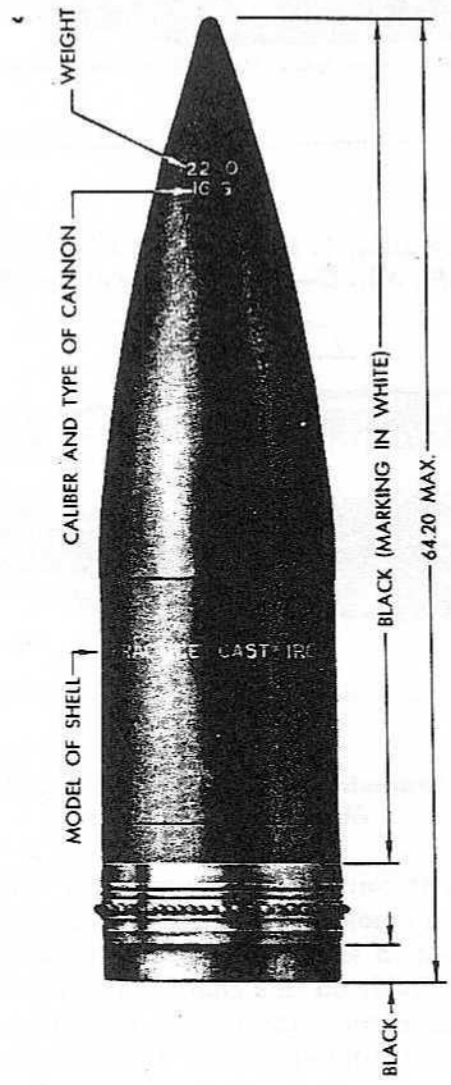
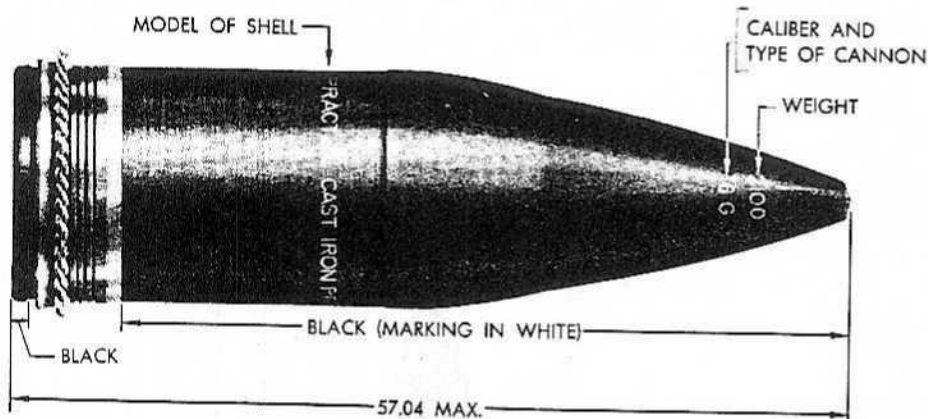

Figure 176—Shell, C. I., 2240-lb., M108, 16-in. Gun,  
Mk. II—Mod. 1 (Navy)

TM 9-471  
52-53

**16-INCH SEACOAST GUN MATERIEL  
GUN MK. II M1; BARBETTE CARRIAGE M4**



RA PD 2143

**Figure 177—Projectile, C. I., 2100-lb., M100, 16-in. Guns, M1919-19MII-19MIII, Mk. II—Mod. 1 (Navy), or How., M1920**

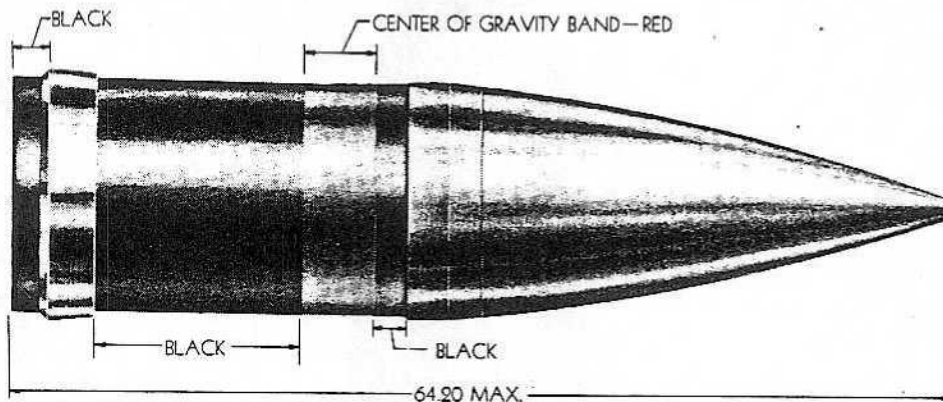

RA PD 7222

**Figure 178—Projectile, Dummy, 2240-lb., M5, 16-in. Gun, Mk. II—Mod. 1 (Navy)**

weighs 720 pounds. It consists of a quantity of small hardwood and lead cylinders (simulated smokeless powder grains) contained in cotton duck bags similar in size and shape to those of the service charge. There are no simulated igniter pads on this charge. A strap of cotton duck is sewed to one end of each section for use in removing the charge from the chamber of the gun by the extractor described in paragraph 69.

**53. FUZES.**

**a. General.** A fuze is a mechanical device used with a projectile to explode it at the time and under the circumstances desired. The fuze authorized for use with the armor-piercing projectiles listed in paragraph 46 is designed to function upon impact with the target and has a delay action of a fraction of a second to permit the projectile to penetrate the target before detonating. Because of its location in the projectile it is

## AMMUNITION

known as a base-detonating (B. D.) fuze. Because of its manner of functioning, it is classified as an impact type fuze.

b. **Boresafe Fuzes.** Dependent upon the method of arming, certain fuzes are considered boresafe. A boresafe fuze is one in which the explosive train is so interrupted that, prior to firing and while the projectile is in the bore of the gun, premature detonation of the bursting charge of the projectile is prevented should any of the more sensitive elements malfunction.

### 54. FUZE, B. D., MK. X.

a. This base-detonating fuze is the standard delay fuze for major caliber armor-piercing projectiles. Due to the arrangement of the explosive elements, it is classified as a boresafe fuze. Being assembled in the base of the projectile and covered by the base cover, the fuze is not visible.

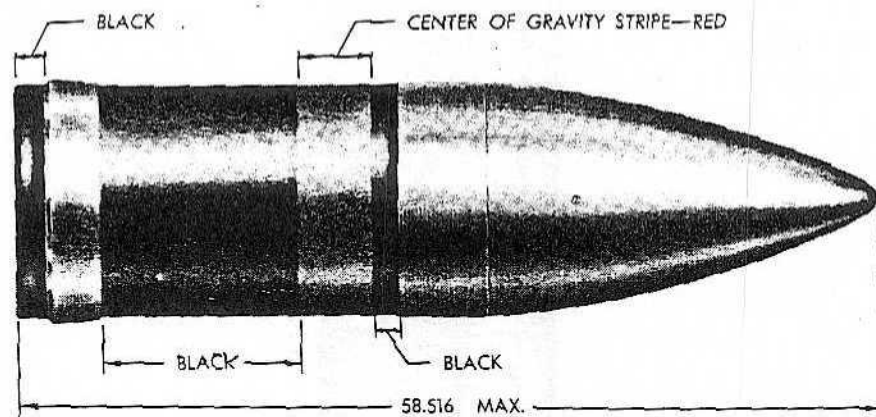

RA PD 2144

Figure 179—Projectile, Dummy, 2100-lb., M3, 16-in. Gun or How.

### 55. PRIMERS.

a. A primer used with rounds of separate loading ammunition consists in general of a small quantity of high explosive which is sensitive to heat or percussion, and an appropriate firing device, together with a quantity of black powder—all contained in a brass cylindrical container similar in shape to a shotgun shell or a blank cartridge. The primer is used for firing the igniter charge which is attached to the propelling charge.

### 56. PRIMER, COMBINATION ELECTRIC AND PERCUSSION, MK. XV—MOD. 1.

a. This primer (fig. 181) is standard for all cannon using separate loading ammunition and equipped with the combination electric-percussion firing mechanism. The primer consists of a brass case which contains a primer charge of 30 grains of black powder and two initiating

16-INCH SEACOAST GUN MATERIEL  
GUN MK. II M1; BARBETTE CARRIAGE M4

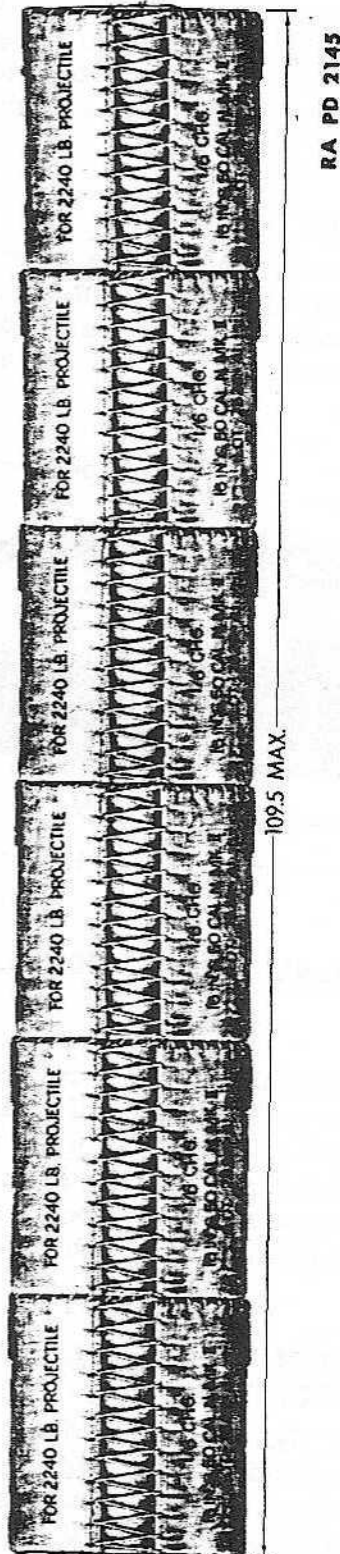

Figure 180—Charge, Propelling, 6 Equal Sections, Stacked, NH Powder, 16-in. Gun, Mk. II—Mod. 1 (Navy), 2240-lb. Proj.

**AMMUNITION**

elements—one electric, the other percussion. Thus, the primer may be fired by percussion should the electric circuit fail.

**57. PACKING.**

a. Complete packing data covering dimensions, volume, and weight of various components of the ammunition described herein are published in SNL P-3, P-4, P-7, and P-8.

b. Although weights of individual projectiles vary somewhat, dependent upon the type and model—likewise, propelling charges de-

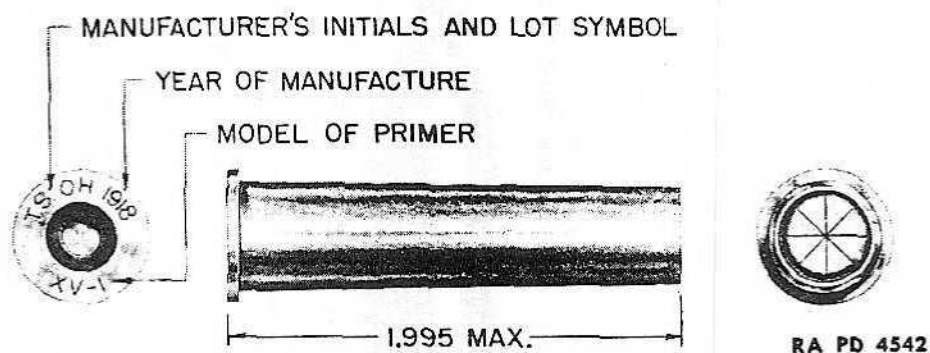
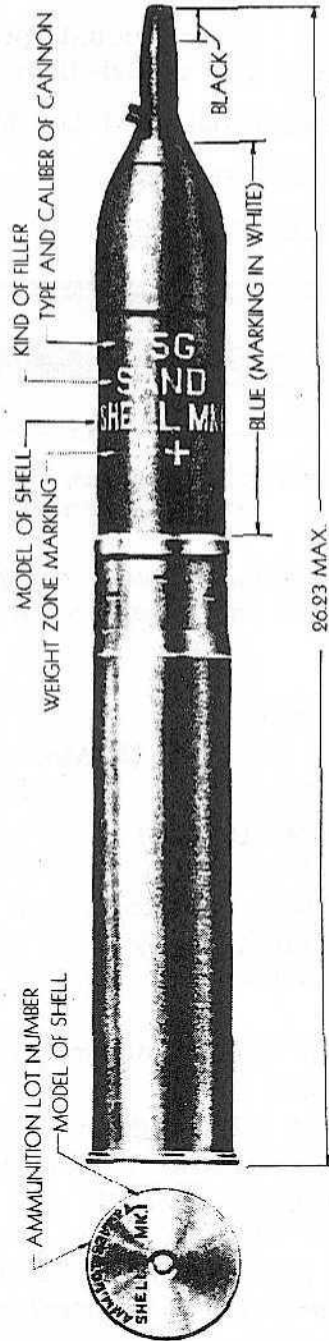

**Figure 181—Primer, Combination, Electric and Percussion, Mk. XV—Mod. I**

pendent upon the particular powder charge—the following data are considered representative for estimating weight and volume requirements:

	WEIGHT (pounds)	VOLUME (cubic feet)
16-in. projectiles as shipped		
Armor-piercing, 2100 lb., Mk. II—Mod. 2, packed one per crate.....	2186	16.82
Over-all dimensions (inches): 64 x 21 <sup>5</sup> / <sub>16</sub> x 21 <sup>5</sup> / <sub>16</sub>		
Practice, 2240 lb., M108, uncrated.....	2241	11.81
Over-all dimensions (inches): 64.2 x 17.83 (diam.)		
Propelling charge		
Full charge without packing material (for 2100-lb. proj.) .....	684.6	
As shipped, packed 1/3 charge in CASE, cartridge, storage, M4A1 .....	350	8.94
Over-all dimensions (inches): 42 <sup>25</sup> / <sub>32</sub> x 19 (diam.)		
Primers, as shipped, packed 24 per metal con- tainer, 42 containers (1008 primers) per box .....	126	2.00
Over-all dimensions of box (inches): 24 x 12 x 12		

**16-INCH SEACOAST GUN MATERIEL  
GUN MK. II M1; BARBETTE CARRIAGE M4**



RA PD 7221

**Figure 182—Shell, Fixed, Practice, Sand Loaded Mk. I, 75-mm Gun  
(w/Inert PDF Mk. IV or M47)**

**AMMUNITION**

**58. SUBCALIBER AMMUNITION.**

a. **General.** The SHELL, fixed, practice, sand loaded, Mk. I, 75-mm Gun (w/inert PDF Mk. IV or M47), is authorized for use in the GUN, 75-mm, M4, when used for subcaliber purposes with the GUN, 16-in., Mk. II-Mod. 1 (Navy). This ammunition is issued in the form of fixed complete rounds. The projectile has an inert filler of sand and is fitted with an inert fuze. The complete round is shown in figure 182, and may be identified by the marking indicated thereon. SHRAPNEL, fixed, Mk. I, 75-mm Gun, if available, may be used as ammunition for the sub-caliber gun.

b. **Packing.** Two standard packings are provided. Data for these packings are as follows:

	WEIGHT (pounds)	VOLUME (cubic feet)
Complete round without packing material....	16.15	
Packed 1 round in individual tin container, 9 containers (9 rds.) per box.....	192	2.72
Over-all dimensions (inches): 29 x 12½ x 13		
Packed 1 round in an individual fiber con- tainer, M21, 3 containers (3 rds.) per bundle .....	59.5	0.96

**59. FIELD REPORT OF ACCIDENTS.**

a. Any serious malfunctions of ammunition must be promptly reported to the ordnance officer under whose supervision the material is issued or maintained (par. 7, AR 45-30).



**16-INCH SEACOAST GUN MATERIEL  
GUN MK. II M1; BARBETTE CARRIAGE M4**

**Section XI**

**SPARE PARTS AND ACCESSORIES**

	<b>Paragraph</b>
Spare parts .....	60
Accessories .....	61
Ammunition truck, 16-inch, M4.....	62
Artillery gun book .....	63
Bore greasing device, 16-inch, M6.....	64
Brushes .....	65
Compressed air cylinder M2 .....	56
Covers .....	67
Dummy projectile .....	68
Extractors .....	69
Eyebolts .....	70
Funnels .....	71
Gages .....	72
Hand rammer .....	73
Loading trough spring compressing screws.....	74
Plumber's force pump .....	75
Reamers .....	76
Reducing valve lifting bolt .....	77
Roller lift hook .....	78
Scrapers .....	79
Screwdrivers .....	80
Shot tongs .....	81
Sponges .....	82
Sponge prop .....	83
Sponge tub .....	84
Staves .....	85
Torsion washer assembly pin .....	86
Vent cleaning bit .....	87
Wrenches .....	88

**60. SPARE PARTS.**

a. Parts become unserviceable through breakage or through wear resulting from continuous usage. For this reason certain parts are provided with the materiel for replacement purposes. These are extra parts provided with the materiel for replacement of those most likely to fail and are for use by the using arm in making minor repairs. Sets of these parts should be maintained as complete as possible at all times and

**SPARE PARTS AND ACCESSORIES**

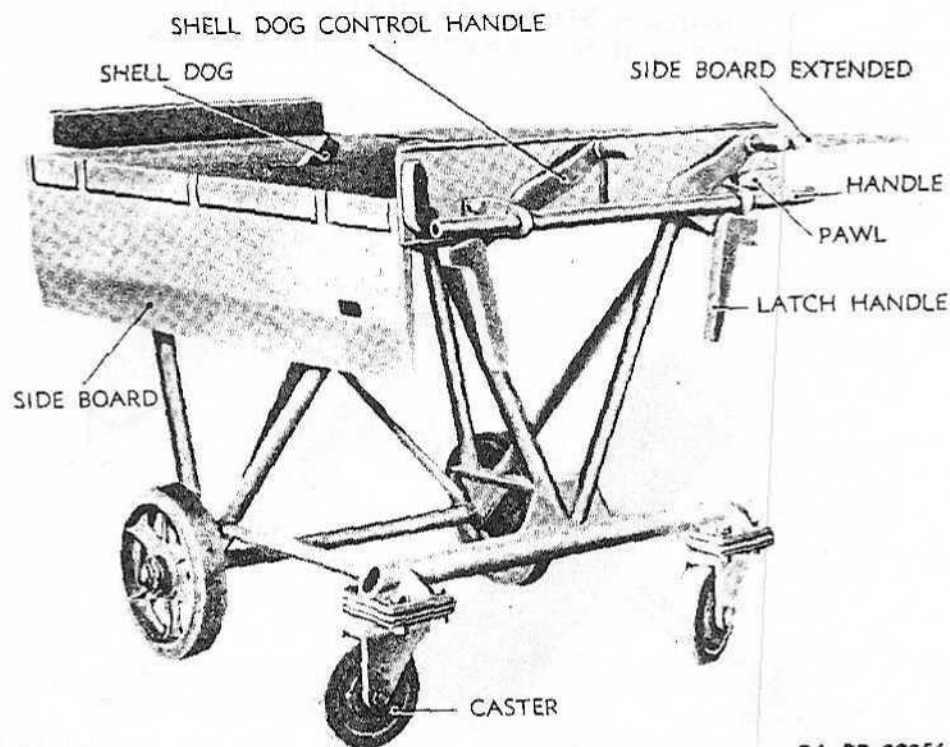

RA PD 33356

**Figure 183—Ammunition Truck, 16-inch, M4**

should be kept clean and oiled to prevent rust. The allowance of spare parts is prescribed in standard nomenclature list E-20.

**61. ACCESSORIES.**

a. Accessories include tools and equipment required for such disassembling and assembling as the using arm is authorized to perform, and for the cleaning and preserving of the gun, carriage, ammunition, etc. They also include chests, covers, tool rolls, and other items necessary to protect the materiel when it is not in use. Additional accessories and supplies of a general nature are provided for battery use. Accessories should not be used for purposes other than as prescribed, and when not in use should be properly stored.

b. There are a number of accessories whose names or general characteristics indicate their use. Others, embodying special features or having special uses, are described below.

**62. AMMUNITION TRUCK, 16-INCH, M4.**

a. The ammunition truck (fig. 183) is made up of an assembly of steel tubing and plates welded and bolted together to form a framework which is supported by two truck wheels, 16 x 3 inches, and two caster wheels. On top of the framework is a table on which the projectile or the powder charge is hauled to the parking tables located on either side of the rammer assembly. The shot truck table is provided with handle

**16-INCH SEACOAST GUN MATERIEL  
GUN MK. II M1; BARBETTE CARRIAGE M4**

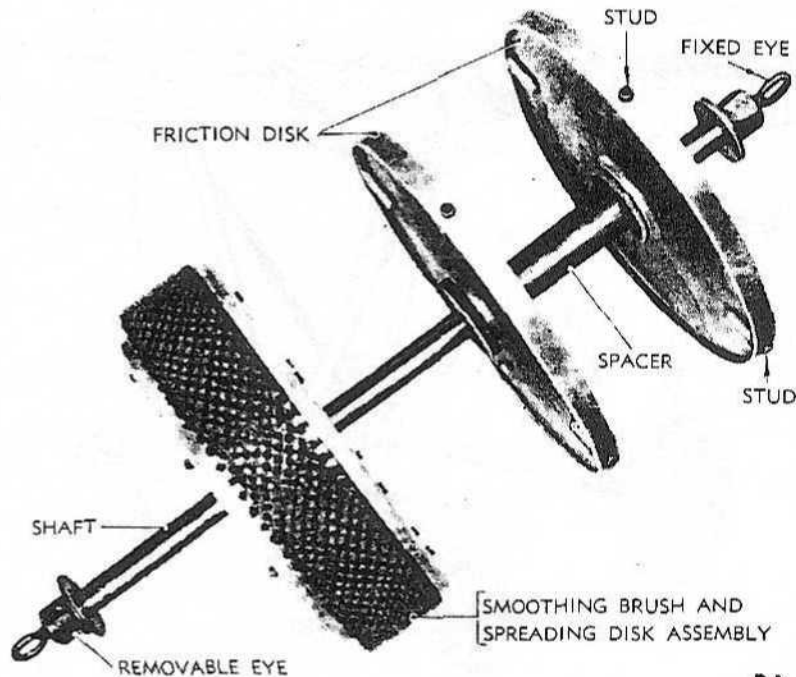

RA PD 33354

**Figure 184—Bore Greasing Device, 16-inch, M6**

that control the shell dogs which keep the projectile from rolling on the shot truck. The side board on each side of the truck is raised to vertical position and locked with the latch handle and pawl when hauling a projectile or powder charge. To roll a projectile off the ammunition truck onto the rammer assembly the side board is extended over the parking table of the rammer assembly. The truck has a filler piece placed between the casters and the truck frame to give the truck the correct height. The truck is of sufficient length to accommodate the largest projectile that might be used. The truck is used to serve the gun when the emplacement is not equipped with overhead trackage for service of the ammunition.

### 63. ARTILLERY GUN BOOK.

a. The gun book (O.O. Form 5825) is used to keep an accurate record of the materiel and remains with the piece regardless of where it may be sent. It includes records of assignments, the battery commander's daily record, and the inspector's record of ammunition, as well as forms to be filled out in case of premature explosions. This book should be in the possession of the organization at all times. It is the sole responsibility of the organization commander as to the completeness of the record and as to the whereabouts of the book. It must also contain the date of issuance of the materiel, to and by whom issued, and the place where issued. If a new gun is installed on the carriage, all data in the old book with reference to sights, carriage, etc., must be copied into the new gun book before the old gun book is relinquished.

SPARE PARTS AND ACCESSORIES

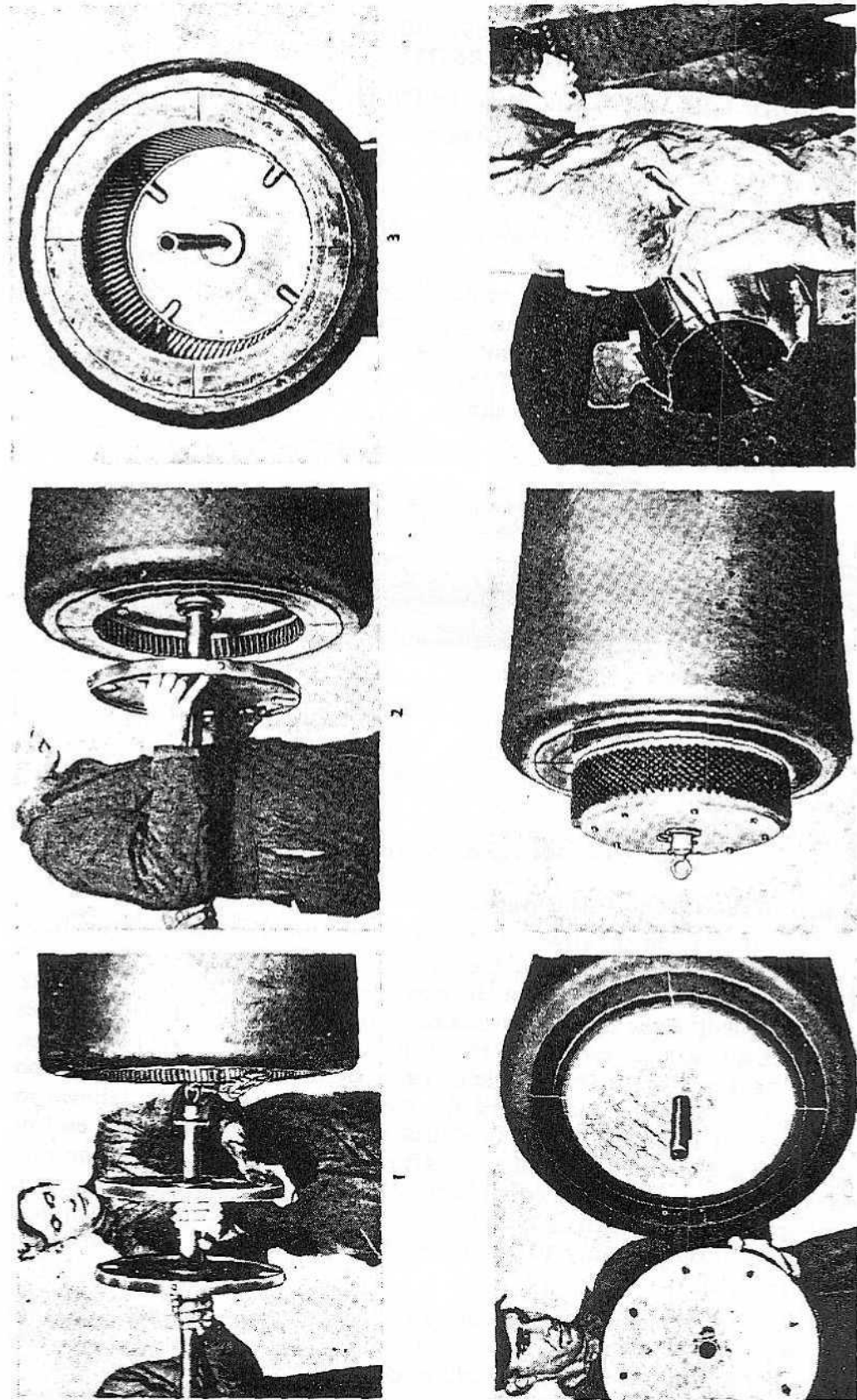

RA PD 5971

Figure 185—Method of Slushing Bore

**16-INCH SEACOAST GUN MATERIEL  
GUN MK. II M1; BARBETTE CARRIAGE M4**

**64. BORE GREASING DEVICE, 16-INCH, M6.**

a. **Description.** The bore greasing device (fig. 184) consists of three parts:

- (1) Two friction disks assembled to a spacer.
- (2) A smoothing brush and spreading disk assembly.

(3) A shaft fitted with an eye on each end. The friction disks serve as guides. They keep the shaft centered and parallel to the bore of the gun. This in turn centers the slushing compound spreading disk, which is assembled to the brush assembly, and insures an even pressure of brush bristles against the bore of the gun. The friction device and brush assembly are free to slide on the shaft.

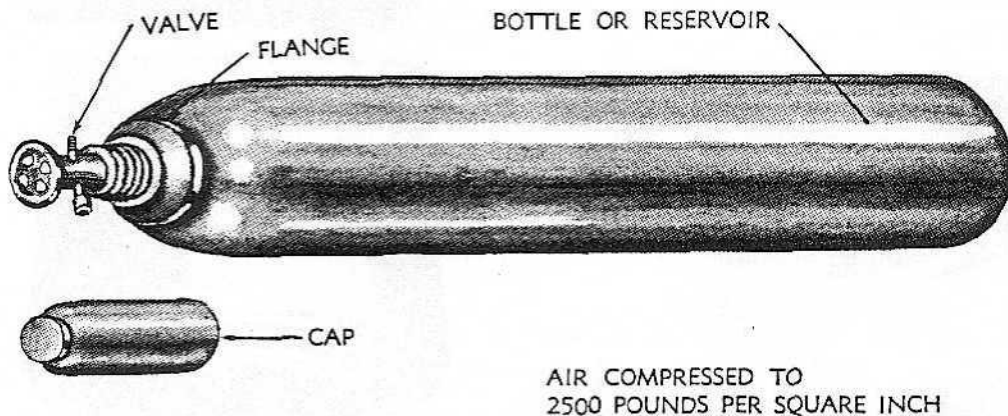

RA PD 33357

**Figure 186—Compressed Air Cylinder M2**

**b. Method of Slushing Bore.**

(1) Attach the dragline to the fixed eye on the shaft of the bore slushing device and insert in the muzzle end of the gun. As the first friction disk enters the bore of the gun, the studs in the rim of the disk (fig. 184) will strike against the muzzle face of the gun. These studs are held out by springs recessed in the disk. Compress the studs by wooden sticks held against their ends and insert both disks. Push the friction disks in, holding the shaft, until the device is in the position shown in (fig. 185-3) i.e., with the friction disk assembly to the extreme end of the shaft and the other end of the shaft extending out beyond the muzzle face of the gun a distance equal to the thickness of the smoothing brush and spreading disk assembly. This will allow the smoothing brush and spreading disk assembly to be fitted after the slushing compound has been applied.

(2) Pack the slushing compound in the muzzle end of the gun (fig. 185-4), taking care to pack solid with no air pockets. Care should also be taken to prevent the bore slushing device from being pushed breechward during this operation. In some instances it may be necessary to hold the shaft in order to prevent this breechward movement.

SPARE PARTS AND ACCESSORIES

RA PD 33355

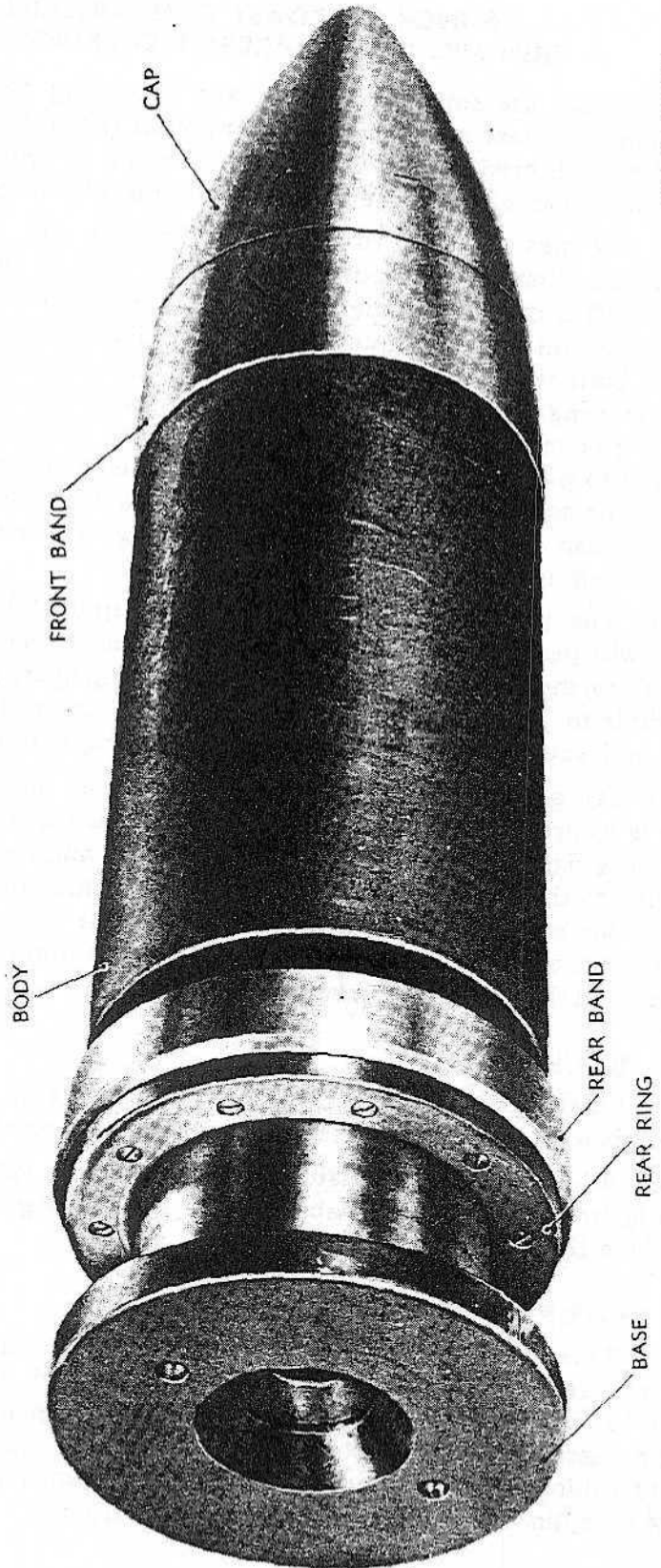

Figure 187—Dummy Projectile

**16-INCH SEACOAST GUN MATERIEL  
GUN MK. II M1; BARBETTE CARRIAGE M4**

(3) Install the smoothing brush and spreading disk assembly with spreading disk next to the slushing compound (fig. 185-5). At this point, coat the brush bristles with slushing compound, to insure slushing of the first few inches of the bore at the beginning of the pulling operation.

(4) By means of the dragline (fig. 185-6) pull the bore slushing device and slushing compound through the bore of the gun. The force of the pull is exerted on the brush and spreading disk assembly which pushes the slushing compound and friction disks through the bore. Pressure is built up against the compound by the resistance of the friction disks, causing the compound to ooze out around the spreading disk and fill the grooves. After the bore slushing device has been drawn through the bore to the point where the friction disks enter the chamber, pressure against the compound is lost and, to compensate for this loss of resistance and to slush the last several inches of rifling, it is necessary to hold a pole or staff against the friction disk.

(5) The pull on the dragline may be supplied by hand or, where space will permit, by tractor. Always take care to keep the direction of pull along the axis of the bore. Once the pulling operation is started, it is desirable to continue the pull until the bore is completely slushed; each stop and start leaves a heavy ring of slushing compound in the bore.

(6) An alternate method of placing the bore slushing device in the bore is to draw it in from the breech end. This can be accomplished by passing a light line through the bore from the muzzle end and attaching the line to the eye on the brush end of the slushing device. As the slushing device is being pulled through by the light line, the dragline to be used in the slushing operation is attached to the other end of the slushing device and drawn through at the same time.

**65. BRUSHES.**

a. **Slush Brush.** The spiral bristle brush (fig. 193) with bronze shank is used for slushing the bore with lubricating oil.

b. **Wire Cleaning Brush.** This brush (fig. 193) is a spiral wire bristle brush with bristles about three inches long. This brush is used to clean the bore of the gun.

**66. COMPRESSED AIR CYLINDER M2.**

a. This is a cylindrical air bottle (fig. 186) in which air is compressed at 2,500 pounds pressure per square inch for transporting but may be compressed to 3,000 pounds per square inch at emplacement. A tubing assembly is connected to the air cylinder and to the recuperator. Both tubing assembly and air cylinder are removed when gun is fired. The air cylinder is used for filling the recuperator.

**67. COVERS.**

a. The *breech cover* is made of two thicknesses of olive drab cotton

SPARE PARTS AND ACCESSORIES

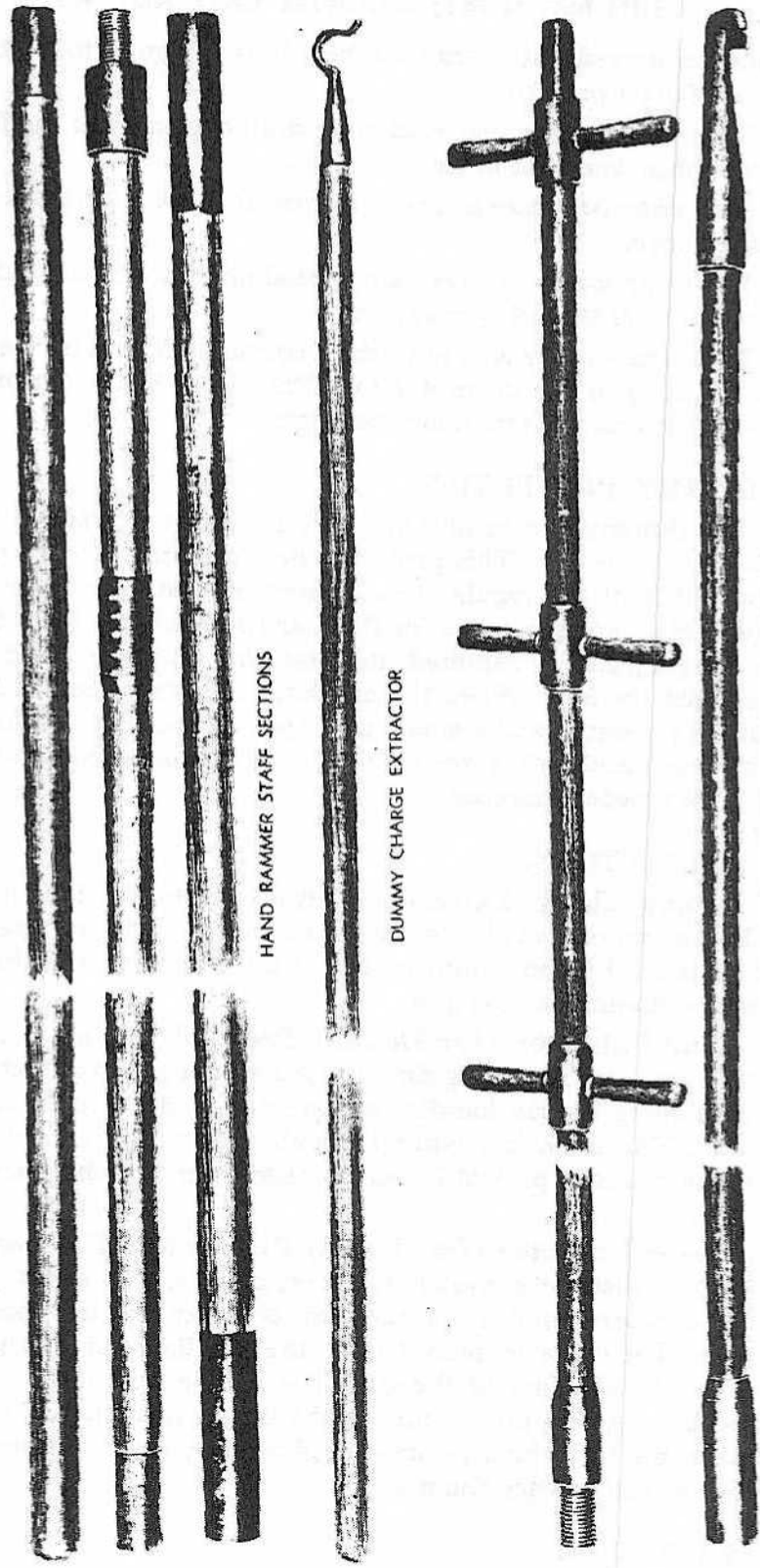

HAND RAMMER STAFF SECTIONS

DUMMY CHARGE EXTRACTOR

HAND EXTRACTOR (FOR DUMMY PROJECTILE)

RA PD 33358

Figure 188—Staves and Extractors



**16-INCH SEACOAST GUN MATERIEL  
GUN MK. II M1; BARBETTE CARRIAGE M4**

duck and reinforced with scrap leather. It is designed to fit the breech of the gun for its protection.

b. The *bore sponge cover* is of olive drab cotton duck made to cover the bore sponge when not in use.

c. The *chamber sponge cover* is similar to the bore sponge cover described above.

d. The *firing magneto cover* is a special olive drab cotton duck cover designed to cover the firing magneto.

e. The *muzzle cover* is of olive drab cotton duck and is laced over the muzzle of the gun for its protection. The cover has a cotton webbing strap which is used for removing the cover.

**68. DUMMY PROJECTILE.**

a. The dummy projectile (fig. 187) is used for practice in loading and unloading the gun. This projectile has the same exterior dimensions as a projectile of the regular service ammunition. The *base* is screwed into the *body* leaving a space for the *rear ring* and *rear band* to slide on. When the projectile is rammed, the *rear ring* and *rear band* are forced back against the *base*. When the extractor is inserted in the hole in the *base* of the projectile and a smart pull applied, the *body* of the projectile hits the *rear band* with force enough to jar it loose from the centering slope of the powder chamber.

**69. EXTRACTORS.**

a. **Dummy Charge Extractor.** This extractor (fig. 188) is 130 inches long. It consists of a cylindrical wooden handle and a bronze hook. The extractor is used to hook into each dummy charge section for removing it from the chamber of the gun.

b. **Hand Extractor (for Dummy Projectile).** The hand extractor (fig. 188) used for removing dummy projectiles is a two-section wooden staff with three bronze handles on one end and a bronze hook on the other end. The hook is pushed through the hole in center of the rear end of the dummy projectile and hooked over the shoulder inside the projectile.

c. **Power Extractor (for Dummy Projectile).** The power extractor (fig. 189) consists of a round steel bar, a yoke, and a nut and washer. The bar is tapered and has a hook on its larger end that hooks into the projectile. The yoke is placed over the smaller end of the bar to fit against the breech face of the gun. The smaller end is threaded for the nut and by screwing up the nut on the bar against the yoke, pressure is applied to the bar which loosens the dummy projectile from the centering slope of the powder chamber.

**70. EYEBOLTS.**

a. **Obturator Spindle Eyebolt.** This is a bolt (fig. 191)  $1\frac{1}{8}$  inches long and  $1\frac{1}{8}$  inches in diameter to one end of which is attached a ring

SPARE PARTS AND ACCESSORIES

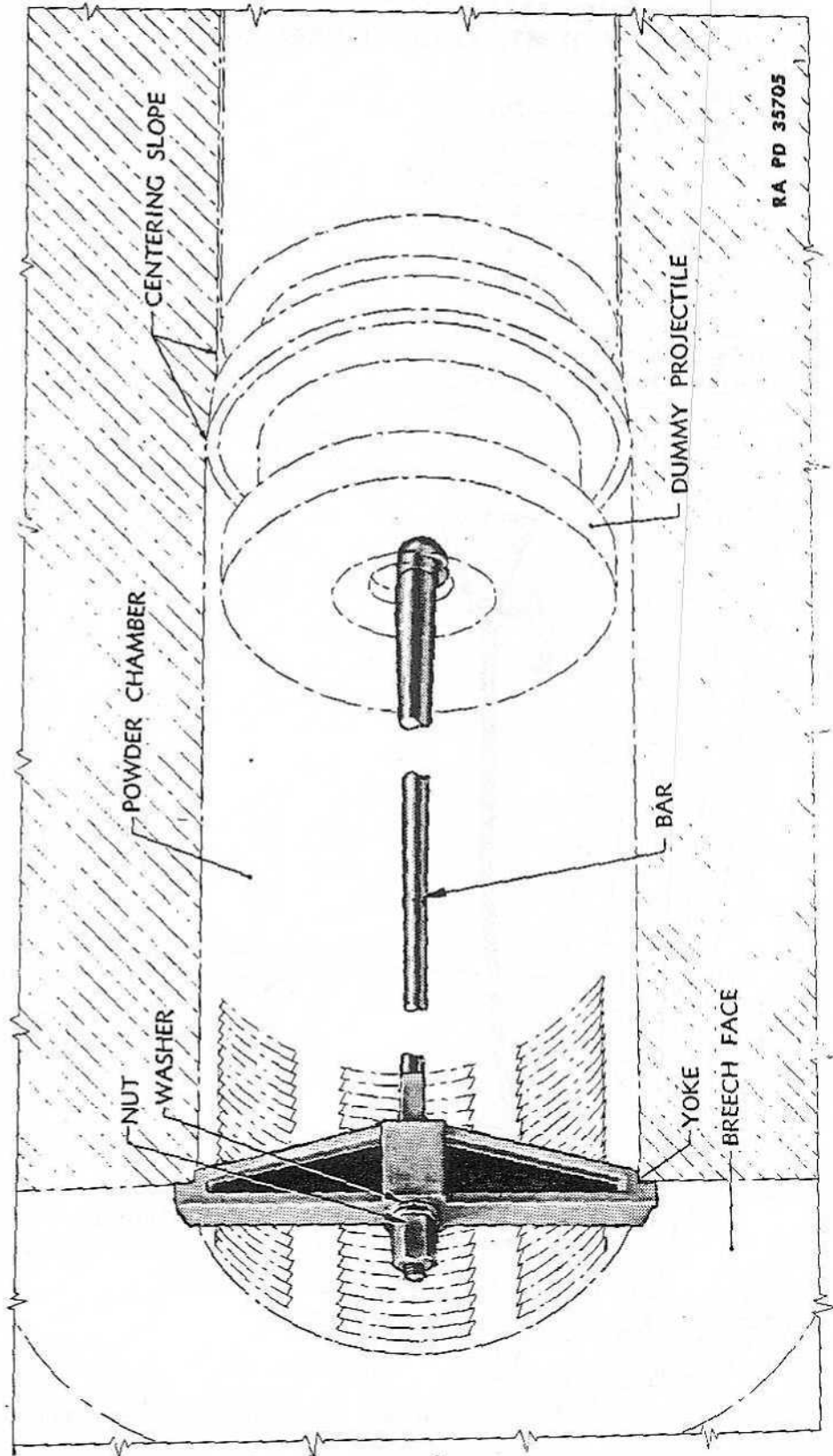
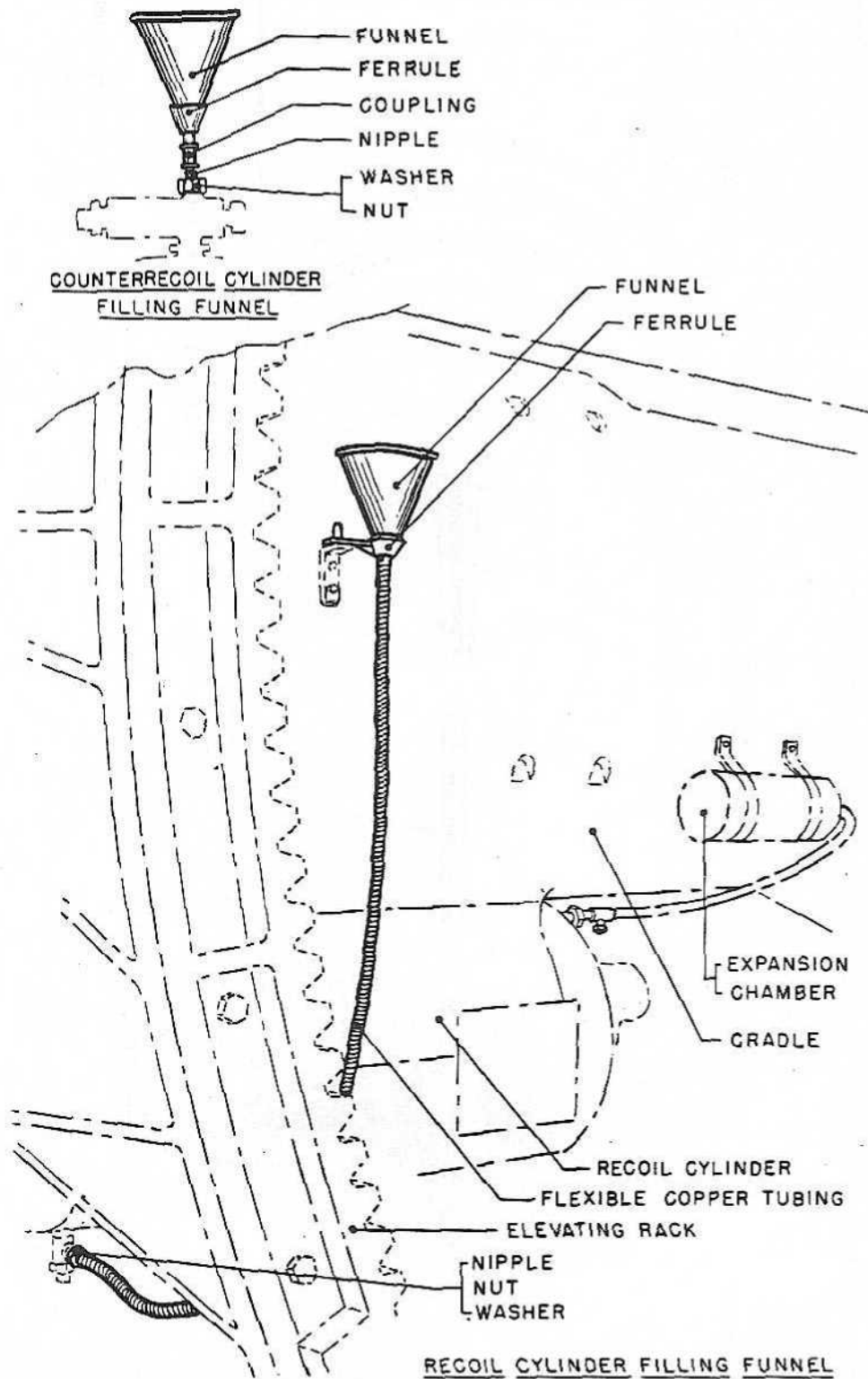

Figure 189—Power Extractor (for Dummy Projectile)

TM 9-471  
70

**16-INCH SEACOAST GUN MATERIEL  
GUN MK. II M1; BARBETTE CARRIAGE M4**



RA PD 33359

**Figure 190—Filling Funnel**